

# LIFEPAK® 15 MONITOR/DEFIBRILLATOR

## SERVICE MANUAL



## Section Navigator

### 1 Introduction

*page 11*

### 5 Performance Inspection Procedures

*page 98*

### 9 Battery Maintenance

*page 278*

### 2 Safety

*page 29*

### 6 Test and Calibration Procedures (TCP)

*page 188*

### 10 Replacement Procedures

*page 289*

### 3 Device Description

*page 48*

### 7 Troubleshooting

*page 218*

### 11 Assembly Diagrams and Parts Lists

*page 486*

### 4 Modes of Operation

*page 89*

### 8 Preventive Maintenance

*page 265*

### Performance Procedure Checklist

*page 647*

### Table of Contents

Section Navigator .....	ii
Introduction .....	11
Trademarks .....	12
Using Adobe Reader.....	13
Navigating Through the Manual.....	14
Service Personnel Qualifications.....	15
Contacting Physio-Control .....	16
Responsibility for Information .....	17
Device Tracking.....	18
Service Information.....	19
Recycling Information .....	20
Warranty.....	21
Configuration Information .....	22
Glossary.....	23
Acronyms.....	25
Safety.....	29
Terms .....	30
General Warnings.....	31
Symbols.....	36
Device Description .....	48
Introduction .....	49
Physical Description and Features .....	54
Devices, Options, Supplies, and Accessories .....	65
System Context Diagrams .....	70
Functional Descriptions.....	74

Modes of Operation.....	89
Manual Mode .....	90
AED Mode .....	91
Setup Mode.....	92
Service Mode.....	94
Demo Mode.....	96
Archive Mode .....	97
Performance Inspection Procedures.....	98
PIP – Scope and Applicability .....	100
PIP – Resource Requirements .....	101
PIP – Test Equipment Requirements .....	102
Manual Mode Access.....	106
PIP – Device Preparation .....	110
Power Management.....	114
PIP – User Test and Date/Time Verification .....	118
Miscellaneous Functions .....	119
PIP – Printer Tests.....	133
PIP – Keypad Tests.....	136
PIP – Audio Test.....	137
PIP – Invasive Pressure Verification - P1, P2 .....	138
PIP – SpO2/SpCO/SpMet Test.....	140
PIP – Recording Operating Data (Optional) .....	141
PIP – ECG Performance Testing .....	142
PIP – Defibrillator/Pacing Testing .....	151
PIP – QUIK-COMBO ECG Characteristic Tests .....	156
PIP – Standard Paddles User Test .....	159
PIP – Standard Paddles Defibrillator Delivered Energy Tests .....	161
PIP – Patient Impedance Test.....	171



Data Management.....	172
PIP – Leakage Current Tests .....	177
PIP – Disabling/Resetting Maintenance Prompt .....	187
Test and Calibration Procedures (TCP).....	188
TCP – Scope and Applicability .....	189
TCP – Resource Requirements .....	190
TCP – Test Equipment Requirements.....	191
TCP – Setup.....	193
TCP – Service/Calibration Submenu Access .....	194
TCP – Temperature Calibration Test.....	195
TCP – Defibrillator Energy Tests .....	199
TCP – Defibrillator Output Waveform Test .....	203
TCP – Defibrillator Isolation Test .....	206
TCP – CO2 Calibration.....	207
TCP – Printer Calibration Tests.....	210
TCP – Pacer Characteristics Tests.....	213
TCP – LIFENET Device Communications Setup.....	216
Troubleshooting.....	218
Troubleshooting Chart .....	219
Using the Service/Status Features .....	226
Device Log .....	228
Device Data.....	230
Service Log .....	233
Processing Service Log Codes .....	235
Counters .....	236
Clear Memory .....	238
Service Log Code Categories .....	239
Utility Service Codes .....	241

User Interface Service Codes .....	242
Data Management Service Codes .....	244
System Monitor Service Codes .....	245
Processor Control Service Codes .....	246
ECG Service Codes.....	248
Patient Parameter Service Codes .....	249
Therapy Service Codes.....	250
Printer Service Codes .....	257
Power Management Service Codes.....	258
Serial Communication Service Codes .....	259
Corrective Action Codes .....	260
Service LED .....	263
Display Pixels Test .....	264
Preventive Maintenance .....	265
Device Self Tests .....	266
Device User Test.....	267
Preventive Maintenance and Testing Schedule.....	268
Scheduled Replacement Items.....	269
Setting/Resetting the Maintenance Prompt Interval .....	270
Device Useful Life.....	271
Support Policy .....	272
Cleaning .....	273
Environmental Conditions .....	275
A12 Printer Maintenance.....	276
Battery Maintenance .....	278
Battery General Characteristics .....	279
Battery Status Indicators .....	280
Battery Performance Characteristics .....	283

Charging the Batteries Using the Station or Mobile Li-ion Battery Charger .....	284
Discarding/Recycling Batteries .....	285
Storing Batteries .....	286
Receiving New Batteries .....	287
Coin Cell Battery .....	288
Replacement Procedures .....	289
Summary of Replacement Procedures .....	290
Warnings and Cautions .....	293
Static-Sensitive Device Handling .....	294
Tools List .....	296
Capacitor Discharge Tool .....	297
Capacitor Discharging Procedure .....	298
Discharging the C15 Pacing Capacitor .....	299
Saving and Restoring the Setup Configuration .....	300
Disassembling the Case .....	301
Reassembling the Case .....	304
Inside Front Case Diagram .....	309
Interface PCB (A05) Replacement .....	310
Backlight PCB (A08) Replacement .....	315
Printer Control Keypad (A09) Replacement .....	318
Main Keypad (A10) Replacement .....	320
Display Shield Replacement .....	322
LCD Display Assembly (A11) Replacement .....	324
Display Lens Replacement .....	326
Front Case Replacement .....	328
System/Interface PCB Cable (W04) Replacement .....	332
Backlight/Interface PCB Cable (W06) Replacement .....	333
Therapy Connector Cable (W11) Replacement .....	334

Printer Control Keypad/Interface PCB Cable (W12) Replacement.....	336
Main Keypad/Interface PCB Cable (W13) Replacement.....	337
Speed Dial Assembly (W15) Replacement: .....	338
Installing the Speed Dial Assembly (W15).....	340
Printer Assembly/Interface PCB Cable (W16) Replacement .....	341
Speaker Assembly (W17) Replacement .....	343
LCD Display Assembly/Interface PCB Cable (W18) Replacement .....	346
Printer Assembly/Chassis Ground Cable (W19) Replacement.....	347
Inside Rear Case Diagrams .....	348
System (A01)/Therapy (A04) PCB Assembly Replacement .....	352
Installing the System (A01)/Therapy (A04) PCB Assembly .....	359
Power PCB (A03) Replacement .....	373
OEM PCB (A06) Replacement.....	381
Transfer Relay Assembly (A13) Replacement.....	388
Energy Storage Capacitor (A15) Replacement .....	391
SpO2 PCB (A16) Replacement.....	394
Interconnect Bracket (A17) Replacement.....	404
NIBP (A21)/CO2 (A23) Module Replacement .....	407
Biphasic Module (A22)/Inductive Resistor (A14) Replacement .....	418
EMI Shield Replacement .....	425
NIBP Connector Replacement.....	426
Parameter Bezel Replacement.....	429
Rear Case Replacement.....	435
Handle Replacement.....	441
Paddle Retainer Cover Replacement .....	442
Power/System PCB Cable (W01) Replacement .....	443
Power/Therapy PCB Cable (W02) Replacement .....	444
Power/Contact PCB Cable (W05) Replacement .....	446

ECG Connector Cable (W07) Replacement .....	448
System Connector Cable (W08) and Auxiliary Connector Cable (W09) Replacement .....	451
Battery Pins / Power PCB Cable (W10) Replacement .....	454
USB Flex Module (W14) Replacement .....	458
Biphasic Cable (W20) Replacement.....	460
OEM PCB/SpO2 (W21) Module Cable Replacement .....	462
SpO2 Connector Cable (W22) Replacement.....	464
OEM PCB/CO2 Module Cable (W26) Replacement .....	466
OEM PCB/NIBP Module Cable (W27) Replacement.....	468
CO2 Inlet Connector Cable (W28) Replacement.....	470
CO2 Adapter Cable (W30) Replacement.....	473
Invasive Pressure Connector Assembly (W33) Replacement.....	475
Temperature Cable Assembly (W35) Replacement.....	477
Contact PCB (A07) Replacement.....	479
Printer Assembly (A12) Replacement.....	480
Coin Battery Replacement .....	482
Battery Pin Replacement .....	484
Software and Device Upgrades .....	485
Assembly Diagrams and Parts Lists.....	486
Section Glossary .....	487
Main Diagrams .....	488
External Parts Diagrams and Lists .....	491
Front Parts Diagrams and Parts List.....	497
System/Therapy PCB Assembly Diagrams and Parts Lists .....	506
Parameter Bezel Diagrams and Parts Lists.....	511
Rear Diagrams and Parts List .....	519
OEM Optional Assemblies, Diagrams and Parts Lists .....	532
Label Language Parts.....	537

Connection Diagrams for Assemblies, Control Boards, Cables, and Connectors .....	562
Repair Kits.....	610
Defibrillator Part Number and Serial Number.....	638
Ordering Parts .....	639
Index.....	640

## Introduction

This service manual describes how to maintain, test, troubleshoot, and repair the LIFEPAK 15 monitor/defibrillator. A separate publication, the *LIFEPAK 15 Monitor/Defibrillator Operating Instructions*, is for use by physicians, clinicians, and emergency care providers. The operating instructions provide step-by-step instructions as well as operator-level testing and maintenance.

**NOTE:** Hyperlinks appear in “[blue text](#).” Text that indicates the name of a button, menu item, or screen message appears in all caps (for example, press ANALYZE, select MANUAL MODE).

This section covers the following topics:

- [Trademarks \(p. 12\)](#)
- [Using Adobe Reader \(p. 13\)](#)
- [Navigating Through the Manual \(p. 14\)](#)
- [Service Personnel Qualifications \(p. 15\)](#)
- [Contacting Physio-Control \(p. 16\)](#)
- [Responsibility for Information \(p. 17\)](#)
- [Device Tracking \(p. 18\)](#)
- [Service Information \(p. 19\)](#)
- [Recycling Information \(p. 20\)](#)
- [Warranty \(p. 21\)](#)
- [Configuration Information \(p. 22\)](#)
- [Glossary \(p. 23\)](#)
- [Acronyms \(p. 25\)](#)

## Trademarks

LIFEPAK, LIFEPAK CR, LIFEPAK EXPRESS, LIFENET, FASTPAK, LIFE•PATCH, QUIK-COMBO, and DERMA-JEL are registered trademarks of Physio-Control, Inc. CODE SUMMARY, CODE-STAT, PARTSLINE, REDI-PAK, Shock Advisory System, SunVue, and DT EXPRESS are trademarks of Physio-Control, Inc. Microsoft and Windows are registered trademarks of Microsoft Corporation in the US and/or other countries. Adobe is a trademark of Adobe Systems Incorporated. Masimo, the Radical logo, Rainbow, and SET are registered trademarks of Masimo Corporation. Red, LNCS, SpCO, and SpMet are trademarks of Masimo Corporation. CapnoLine and FilterLine are registered trademarks of Oridion Medical, Ltd. The Oridion medical capnography in this product is covered by one or more of the following US patents: 6,428,483; 6,997,880; 5,300,859; 6,437,316 and their foreign equivalents. Additional patent applications pending. Fluke and BIO-TEK are registered trademarks and QED-6H is a trademark of Fluke Biomedical Corporation. Bluetooth is a registered trademark of Bluetooth SIG, Inc. CASMED is a registered trademark of CAS Medical Systems, Inc. SIGNAGEL is a registered trademark of Parker Laboratories. EDGE System Technology is a trademark of Ludlow Technical Products. Specifications are subject to change without notice.



© 2011 Physio-Control, Inc. All rights reserved.

**MIN** 3309059-000



## Using Adobe Reader

### Accessing Adobe Reader Help

This service manual opens in Adobe® Reader, which is included on this documentation CD. For additional assistance using the Adobe Reader program, access ADOBE READER HELP in the HELP menu.

### Using Bookmarks

Bookmarks appear in a column on the left side of the screen. They enable you to easily navigate to main sections of the manual, similar to a table of contents.

To view or hide the bookmarks column, click the BOOKMARKS tab located along the left side of the screen.



To jump to a bookmark topic, click the desired topic.

**NOTE:** A plus sign to the left of a bookmark topic indicates additional topics exist under that bookmark level. Click the plus sign to expand or collapse the bookmarks.



### Using Page View

Click the PAGES tab located to the far left of the screen to view miniature images of each page in the document. Scroll through the pages and click an image to jump quickly to that page.

## Navigating Through the Manual

Blue text indicates a hyperlink. Click a link to jump to that topic or page. Click  **Back** in the navigation bar (at the bottom of each page) to return to your previous location. The pointer changes to a pointing finger  when positioned over a link. A navigation bar at the bottom of each page also provides helpful links.

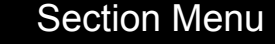
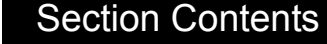
The navigation bar includes:

-  **Section Menu** Click to jump to the main table of contents for the manual.
-  **Section Contents** Click to jump to the table of contents for the section you are currently viewing.
-  **Back** Click to retrace your steps in a document, returning to each page in the reverse order visited.
-  **Index** Click to jump to the manual's index.

## Service Personnel Qualifications

Service technicians must be properly qualified and thoroughly familiar with the operation of the LIFEPAK 15 monitor/defibrillator. They must meet at least one of the following requirements (or the equivalent):

- Associate of Applied Science, with an emphasis in biomedical electronics
- Certificate of Technical Training, with an emphasis in biomedical electronics
- Equivalent biomedical electronics experience

## Contacting Physio-Control

### **Physio-Control, Inc.**

11811 Willows Road NE

Redmond, WA 98052-2003 USA

Telephone: 425.867.4000

Toll Free (USA only): 800.442.1142

Fax: 1.425.867.4861

**Internet:** [www.physio-control.com](http://www.physio-control.com)

## Responsibility for Information

This service manual describes the methods required to maintain, test, and repair the LIFEPAK 15 monitor/defibrillator. This manual does not address the operation of the device. Qualified service personnel (see [Service Personnel Qualifications on page 15](#)) must consult this manual and the *LIFEPAK 15 Monitor/Defibrillator Operating Instructions* to obtain a complete understanding of the use and maintenance of the device.

It is the responsibility of our customers to ensure that the appropriate person(s) within their organization has access to the information in this service manual, including any warnings and cautions used throughout the manual.

## Device Tracking

### **!USA** Device Tracking:

The U.S. Food and Drug Administration requires defibrillator manufacturers and distributors to track the location of their defibrillators. If the device is located somewhere other than the shipping address or the device has been sold, donated, lost, stolen, exported, destroyed, permanently retired from use, or if the device was not obtained directly from Physio-Control, please do one of the following: register the device at <http://www.physio-control.com>, call the device registration phone line at 1.800.426.4448, or use one of the postage-paid address change cards located in the back of the *LIFEPAK 15 Monitor/Defibrillator Operating Instructions*, to update this vital tracking information.

### Service Information

Before attempting to clean or repair any assembly in the device, the service technician should be familiar with the information provided in [Preventive Maintenance \(p. 265\)](#).

A qualified service technician (see [Service Personnel Qualifications on page 15](#)) should inspect any device that has been dropped, damaged, or abused to verify that the device is operating within performance standards listed in the [Performance Inspection Procedures \(p. 98\)](#) (PIP) section, and that the leakage current values are acceptable.

Replacement procedures for the device are limited to those items accessible at the final assembly level. Replacements and adjustments must be made by qualified service personnel. Replacements at the final assembly level simplify repair and servicing procedures and help ensure correct device operation and calibration.

To obtain service and maintenance for your device, contact your local Physio-Control service or sales representative. In the USA, call Physio-Control Technical Support at 1.800.442.1142. Outside the USA, contact your local Physio-Control representative. When you call Physio-Control to request service, provide the following information:

- Model number and part number
- Serial number
- Observation of the problem that led to the call

## Recycling Information

Recycle the device at the end of its useful life.

- Recycling assistance – The device should be recycled according to national and local regulations. For instructions on disposing of this product or its accessories, see <http://recycling.medtronic.com>.
- Preparation – The device should be clean and contaminant-free prior to being recycled.
- Recycling of disposable electrodes – After using disposable electrodes, follow your local clinical procedures for recycling.
- Recycling of batteries – The device uses rechargeable Lithium-ion batteries. Follow local guidelines and instructions provided in this service manual for discarding and recycling batteries as described in [Discarding/Recycling Batteries \(p. 285\)](#)
- Packaging – packaging should be recycled according to national and local regulations.



## Warranty

Refer to the warranty statement included with the product. For duplicate copies, contact your local Physio-Control representative. In the US, call 1.800.442.1142. Outside the USA, contact your local Physio-Control representative.

Using defibrillation electrodes, adapter devices, or other parts and supplies from sources other than Physio-Control is not recommended. Physio-Control has no information regarding the performance or effectiveness of its LIFEPAK defibrillators if they are used in conjunction with defibrillation electrodes or other parts and supplies from other sources. If device failure is attributable to defibrillation electrodes or other parts or supplies not manufactured by Physio-Control, this may void the warranty.

## Configuration Information

This service manual is relevant for the following devices and options:

- LIFEPAK 15 monitor/defibrillator Version 1 (V1) device without auxiliary power option
- LIFEPAK 15 monitor/defibrillator Version 2 (V2) device with auxiliary power option
- ECG monitoring — standard
- Manual mode defibrillation — standard
- AED mode — standard
- Noninvasive pacing — standard
- *Bluetooth*® wireless technology option (within approved countries)
- 12-lead ECG option
- Oridion® CO2 option
- Masimo® SpO2/SpCO™/SpMet™ options
- CASMED® NIBP monitoring option
- 2 Channel Invasive pressure option
- Vital signs and ST trending option
- Temperature monitoring option (V2 only; temperature option and invasive pressure option cannot be installed on the same device)

## Glossary

The following are definitions of terms used throughout this service manual.

- Biphasic waveform — Characterized by a positive current phase followed by a reverse current phase of shorter duration and decreased magnitude. The waveform pulse characteristic is biphasic truncated exponential (BTE).
- Automated external defibrillator (AED) — An Automated ECG analysis and a prompted treatment protocol for patients in cardiac arrest.
- Shock Advisory System (SAS) — A computerized ECG analysis system used in AED mode for detecting a shockable rhythm. For more information about SAS, see Appendix C in the operating instructions.
- Continuous patient surveillance system (CPSS) — A feature that monitors the patient ECG in LEADS or PADDLES for a potentially shockable rhythm. CPSS is active when the VF/VT ALARM is selected ON (Setup/Alarms) or after pressing the ALARMS button. For more information about CPSS, see Appendix C in the operating instructions.
- CODE SUMMARY™ report — A summary report that includes the ECG segments associated with key events, such as analysis or shock. See “Data Management” in the operating instructions for a sample CODE SUMMARY report.
- CO2 monitor — An optional noninvasive capnometer that monitors CO2, EtCO2, FiCO2, and respiration rate (referred to henceforth as CO2).
- End-tidal carbon dioxide (EtCO2) — EtCO2 is the measurement of CO2 at the end of expiration.
- Event log summary — A report summarizing important events for a particular patient record; part of the CODE SUMMARY report.
- Noninvasive blood pressure (NIBP) — An optional oscillometric measurement of systolic, diastolic, and mean arterial blood pressure, along with pulse rate.
- Noninvasive pacing — A standard feature that delivers repetitive electrical stimuli to the heart through large adhesive electrodes placed on the patient’s chest.

- QUIK-COMBO® pacing/defibrillation/ECG electrodes — An electrode system that allows monitoring of ECG, delivery of pacing and defibrillation therapy to the patient.
- QUIK-COMBO patient simulator — A combination QC therapy cable and ECG lead cardiac rhythm simulator. The simulator is designed for use in training clinical personnel to operate the LIFEPAK 15 monitor/defibrillator.
- Pulse Co-oximeter — An optional noninvasive pulse oximeter that measures the saturation of oxygen in arterial blood, carboxyhemoglobin and methemoglobin concentrations, respectively.
- SpO2/SpCO/SpMet — The measure of functional oxygen saturation (SpO2), carboxyhemoglobin concentration (SpCO), and methemoglobin concentration (SpMet) in the blood.
- Test Load — An accessory shipped with the LIFEPAK monitor/defibrillator that connects to the QUIK-COMBO therapy cable. It provides a 50 ohm load for shock discharge through the therapy cable.
- Vital sign (VS) and ST segment Trends — An optional trending feature that can graphically display and document a patient's vital signs and ST segment measurements for up to eight hours.

## Acronyms

Table 1.1 lists acronyms and abbreviations used in this manual.

**Table 1.1— Acronyms and Abbreviations**

Term	Description
AAMI	Association for the Advancement of Medical Instrumentation
ADC	Analog-to-digital conversion
AED	Automated external defibrillator
Ah	Ampere hour
AHA	American Heart Association
AMI	Acute myocardial infarction
ANSI	American National Standards Institute
ASIC	Application-specific integrated circuit
BF	Electrically isolated, external body connection
BPM	Beats per minute
BTE	Biphasic truncated exponential
CF	Electrically isolated, direct cardiac connection
CO2	Carbon dioxide

**Table 1.1— Acronyms and Abbreviations (Continued)**

CPR	Cardiopulmonary resuscitation
CPU	Central processing unit
CPSS	Continuous patient surveillance system
DDE	Disposable defibrillation electrodes
DMM	Digital multimeter
DSP	Digital signal processor
DUART	Dual universal asynchronous receiver/transmitter
ECG	Electrocardiogram
EMS	Emergency medical service
ESCC	Energy storage capacitor charger
ESD	Electrostatic discharge
ESU	Electrosurgical unit
EtCO <sub>2</sub>	End-tidal carbon dioxide
FiCO <sub>2</sub>	Inspired carbon dioxide
HR	Heart rate
IEC	International Electrical Commission
IP	Invasive pressure
LCD	Liquid crystal display

**Table 1.1— Acronyms and Abbreviations (Continued)**

LED	Light-emitting diode
Li-ion	Lithium-ion
mmHg	Millimeters of mercury
NIBP	Noninvasive blood pressure
NSR	Normal sinus rhythm
OEM	Original equipment manufacturer
RR	Respiration rate
PC	Personal computer
PCB	Printed circuit board
PIP	Performance inspection procedure
PPM	Pulses per minute
PR	Pulse rate
QRS	Refers to portions of the ECG waveform
RTC/NVRAM	Real-time clock/non-volatile random-access memory
RTS	Radio transparent system
SAS	Shock Advisory System
SBC	Single-Board Computer
SpCO	Measurement of carboxyhemoglobin concentration

**Table 1.1— Acronyms and Abbreviations (Continued)**

SpO2	Measurement of oxygen saturation
SpMet	Measurement of methemoglobin concentration
SSD	Static-sensitive device
TCP	Test and calibration procedure
USB	Universal serial bus
VF	Ventricular fibrillation
VS	Vital signs
VT	Ventricular tachycardia
μA	MicroAmpere



## Safety

This section describes the general safety conventions, terms, and symbols used in this service manual or on the LIFEPAK 15 monitor/defibrillator front and rear panels. This information is intended to alert service personnel to recommended precautions in the care, use, and handling of this medical device.

- [Terms \(p. 30\)](#)
- [General Warnings \(p. 31\)](#)
- [Symbols \(p. 36\)](#)

## Terms

The following terms are used in this service manual or on the various configurations of the LIFEPAK 15 monitor/defibrillator (device). Familiarize yourself with their definitions and significance.

### **DANGER**

Immediate hazards that will result in serious personal injury or death.

### **WARNING**

Hazards or unsafe practices that may result in serious personal injury or death.

### **CAUTION**

Hazards or unsafe practices that may result in minor personal injury, product damage, or property damage.

## General Warnings

The following are general danger, warning, and caution statements. Keep them in mind when working with the LIFEPAK 15 monitor/defibrillator (device). Additional specific warnings and cautions appear throughout this service manual and the *LIFEPAK 15 Monitor/Defibrillator Operating Instructions*.

### DANGER

#### EXPLOSION HAZARD

Do not use this defibrillator in the presence of flammable gases or anesthetics.

#### SHOCK HAZARD

Do not disassemble the defibrillator. It contains no operator serviceable components and lethal voltages may be present. Contact authorized service personnel for repair.

## WARNINGS

### SHOCK OR FIRE HAZARDS

#### **SHOCK HAZARD**

The defibrillator delivers up to 360 joules of electrical energy. Unless properly used as described in these operating instructions, this electrical energy may cause serious injury or death. Do not attempt to operate this device unless thoroughly familiar with these operating instructions and the function of all controls, indicators, connectors, and accessories.

#### **SHOCK OR FIRE HAZARD**

Do not immerse any portion of this defibrillator in water or other fluids. Avoid spilling any fluids on defibrillator or accessories. Spilled liquids may cause the defibrillator and accessories to perform inaccurately or fail. Do not clean with ketones or other flammable agents. Do not autoclave or sterilize this defibrillator or accessories unless otherwise specified.

#### **POSSIBLE FIRE**

Use care when operating this device close to oxygen sources (such as bag-valve-mask devices or ventilator tubing). Turn off gas source or move source away from patient during defibrillation.

### WARNINGS (CONTINUED)

#### ELECTRICAL INTERFERENCE HAZARDS

##### **POSSIBLE ELECTRICAL INTERFERENCE WITH DEVICE PERFORMANCE**

Equipment operating in close proximity may emit strong electromagnetic or radio frequency interference (RFI), which could affect the performance of this device. If use of equipment in close proximity is necessary, observe the device to verify normal operation in the configuration in which the device will be used. RFI may result in distorted ECG, incorrect ECG lead status, failure to detect a shockable rhythm, cessation of pacing, or incorrect vital sign measurements. Avoid operating the device near cauterizers, diathermy equipment, or other portable and mobile RF communications equipment. Do not rapidly key EMS radios on and off. Refer to Appendix D in the Operating Instructions for recommended distances of equipment. Contact Physio-Control Technical Support if assistance is required.

##### **POSSIBLE ELECTRICAL INTERFERENCE**

Using cables, electrodes, or accessories not specified for use with this defibrillator may result in increased emissions or immunity from electromagnetic or radio frequency interference (RFI) which could affect the performance of this defibrillator or of equipment in close proximity. Use only parts and accessories specified in these operating instructions.

## WARNINGS (CONTINUED)

### POSSIBLE ELECTRICAL INTERFERENCE

This defibrillator may cause electromagnetic interference (EMI) especially during charge and energy transfers. EMI may affect the performance of equipment operating in close proximity. Verify the effects of defibrillator discharge on other equipment prior to using the defibrillator in an emergency situation, if possible.

### IMPROPER DEVICE PERFORMANCE HAZARDS

#### POSSIBLE IMPROPER DEVICE PERFORMANCE

Using other manufacturers' cables, electrodes, power adapters, or batteries may cause the device to perform improperly and may invalidate the safety agency certifications. Use only the accessories that are specified in these operating instructions.

#### POSSIBLE IMPROPER DEVICE PERFORMANCE

Changing factory default settings will change the behavior of the device. Changes to the default settings must only be made by authorized personnel.

### POSSIBLE DEVICE SHUTDOWN

Always have immediate access to a spare, fully charged, properly maintained battery. Replace the battery when the device displays a low battery warning.

## WARNINGS (CONTINUED)

### SAFETY RISK AND POSSIBLE EQUIPMENT DAMAGE

#### **POSSIBLE INJURY OR SKIN BURNS**

Monitors, defibrillators, and their accessories (including electrodes and cables) contain ferromagnetic materials. As with all ferromagnetic equipment, these products must not be used in the presence of the high magnetic field created by a Magnetic Resonance Imaging (MRI) device. The high magnetic field created by an MRI device will attract the equipment with a force sufficient to cause death or serious personal injury to persons between the equipment and the MRI device. This magnetic attraction may also damage and affect the performance of the equipment. Skin burns will also occur due to heating of electrically conductive materials such as patient leads and pulse oximeter sensors. Consult the MRI manufacturer for more information.

#### **POSSIBLE SKIN BURNS**

A defect in the neutral electrode connection on HF surgical equipment could cause burns at the lead or sensor site and damage to the monitor/defibrillator. Do not apply patient leads or sensors when using high frequency (HF) surgical (electrocautery) equipment.

## Symbols

The following list includes symbols that may be used in this service manual or on various configurations of the LIFEPAK 15 monitor/defibrillator and accessories. Some symbols may not be relevant to your device or used in every country.

Table 2.1—Symbols







Symbol	Description
Device or User Interface	
	Attention, consult accompanying documents
	Alarm on
	Alarm off
	VF/VT alarm on
	VF/VT alarm is on, but is silenced or suspended
	Battery in well, fully charged. For a description of all battery indicators, see <a href="#">Battery Status Indicators (p. 280)</a> .



Table 2.1—Symbols (Continued)







Symbol	Description
	Heart rate/pulse rate indicator
	<i>Bluetooth</i> wireless technology
	Shock count (x) on screen
	Shock button on front panel or hard paddles
	Auxiliary power indicator
	Battery charging indicator
	Service indicator
>	Greater than
<	Less than

Table 2.1—Symbols (Continued)







Symbol	Description
J	Joules
	Display mode button
	Home Screen button
	CO <sub>2</sub> exhaust
	Input/output
	Defibrillation-proof type CF patient connection
	Defibrillation protected, type BF patient connection
	Do not dispose of this product in the unsorted municipal waste stream. Dispose of this product according to local regulations. See <a href="http://recycling.medtronic.com">http://recycling.medtronic.com</a> for instructions on disposing of this product.

Table 2.1—Symbols (Continued)









Symbol	Description
	Mark of conformity to applicable European Directives
	Canadian Standards Association certification for Canada and the United States
	Date of manufacture.
	Authorized EC representative
	Manufacturer's identification number (part number)
	Serial number
	Reorder number
	By prescription only
	For USA audiences only

Table 2.1—Symbols (Continued)



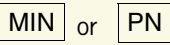

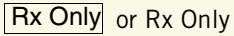

Symbol	Description
	Catalog number
	Manufacturer
 N13571	Indicates that a product complies with applicable ACA standards
	Positive terminal
	Negative terminal
	Fuse
	Battery
	Static-sensitive device. Static discharge may cause damage.

Table 2.1—Symbols (Continued)





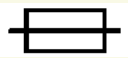
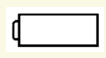

Symbol	Description
Reports	
	Biphasic defibrillation shock
	Pace arrow, noninvasive pacing
	Pace arrow, internal pacing detection
	QRS sense marker
	Event marker
Accessories	
	Mark of conformity to applicable European Directives
	Recognized component mark for the United States

Table 2.1—Symbols (Continued)







Symbol	Description
	Recognized component mark for Canada and the United States
	Complies with (USA) Federal Communications Commission regulations
	Type BF patient connection
	Lot number (batch code). YY (year) and WW (week) of manufacture.
IP44	Enclosure ingress protection code per IEC 60529
 or 	Warning, high voltage
	<b>CAUTION - FIRE HAZARD</b> Do not disassemble, heat above 100°C (212°F), or incinerate battery
	<b>CAUTION - FIRE HAZARD</b> Do not crush, puncture, or disassemble battery
	Use By date shown: yyyy-mm-dd or yyyy-mm

Table 2.1—Symbols (Continued)



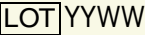
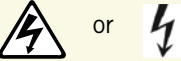



Symbol	Description
	Indoor use only
	Item is latex free
	Lead free
	Dispose of properly
	Store in a cool, dry location (0° to 50°C, 32° to 122°F)
	Single use only
	2 electrodes in 1 package
	10 packages in 1 shelf-pak
	5 shelf-paks in 1 case

Table 2.1—Symbols (Continued)







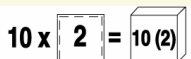
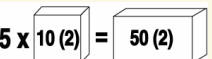

Symbol	Description
	Shave patient skin
	Clean patient skin
	Treatment
	Tear here
	Press electrode firmly onto patient
	Connect QUIK-COMBO cable
	Slowly peel back protective liner on electrode
	Do not use this pediatric QUIK-COMBO electrode on LIFEPAK 500, LIFEPAK 1000, LIFEPAK CR <sup>®</sup> Plus, or LIFEPAK EXPRESS <sup>®</sup> defibrillators



Table 2.1—Symbols (Continued)









Symbol	Description
	For use on adults
	Not for use on adults
	For use on children up to 15 kg (33 lb)
	Not for use on children under 15 kg (33 lb)
	Remove label from battery
	Charge battery
	Insert battery in LIFEPAK 15 monitor/defibrillator
	Rechargeable battery

Table 2.1—Symbols (Continued)













Symbol	Description
	AC-DC power adapter
	DC-DC power adapter
	For use with the LIFEPAK 15 monitor/defibrillator
	Power input
	Power output
	DC voltage
	AC voltage
Shipping carton	
	This end up

Table 2.1—Symbols (Continued)

Symbol	Description
	Fragile/breakable Handle with care
	Protect from water
	Recommended storage temperature -20° to 60°C (-4° to 140°F)
	Relative humidity range 10 to 95%
	Recycle this item

## Device Description

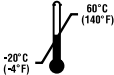
This section describes the physical characteristics and functionality of the LIFEPAK 15 monitor/defibrillator (device). Topics include input signals, assembly functions, and device outputs.

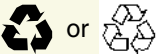
- [Introduction \(p. 49\)](#)
- [Physical Description and Features \(p. 54\)](#)
- [Devices, Options, Supplies, and Accessories \(p. 65\)](#)
- [System Context Diagrams \(p. 70\)](#)
- [Functional Descriptions \(p. 74\)](#)

## Introduction

The introduction provides general information about the LIFEPAK Monitor/Defibrillator including the following topics:

- [About the Device \(p. 49\)](#)
- [Defibrillation Waveform \(p. 49\)](#)
- [Energy Delivery \(p. 49\)](#)
- [Pacing Waveform \(p. 50\)](#)
- [In AED Mode Operation \(p. 50\)](#)
- [Manual Mode Operation \(p. 50\)](#)
- [Device Primary Functions \(p. 50\)](#)
- [Assemblies \(p. 52\)](#)

### About the Device

The LIFEPAK 15 monitor/defibrillator provides innovative solutions for emergency response care, all the way from first responders to throughout the hospital. The Version 1 (V1) device does not have the auxiliary power option. The Version 2 (V2) device has the auxiliary power option.

### Defibrillation Waveform

The device generates a biphasic truncated exponential (BTE) shock pulse for defibrillation.

### Energy Delivery

The device standard method of defibrillation energy delivery is through self-adhesive QUIK-COMBO pacing/defibrillation/ECG electrodes. When using these disposable electrodes (DDEs), internal circuitry continuously measures the impedance between the electrodes and allows defibrillation only when the defibrillation electrodes are attached to the patient. The user can select from a variety of optional accessories for energy delivery (for example, hard paddles).

### Pacing Waveform

The device generates a Monophasic, truncated exponential current pulse.

### In AED Mode Operation

In the AED mode, see [AED Mode \(p. 91\)](#), the operator is prompted to press **ANALYZE**, which allows the Shock Advisory System (SAS) to analyze the ECG rhythm and make recommendations. The operator then follows a prompted protocol for administering defibrillation therapy. For more information about AED mode, see section 5 in the operating instructions.

### Manual Mode Operation

In Manual mode, see [Manual Mode \(p. 90\)](#), the LIFEPAK 15 monitor/defibrillator is a direct current defibrillator that applies a brief, intense pulse of electricity to the heart muscle. Manual mode requires operator interpretation of the ECG rhythm and interaction with the device in order to defibrillate the patient. For more information about Manual mode, see section 5 in the operating instructions.

### Device Primary Functions

The device has six primary functions:

- Defibrillation
  - ~ Manual or semi-automatic (AED) defibrillation
  - ~ Leads-off detection for therapy and ECG electrodes
  - ~ Synchronized cardioversion
- Noninvasive pacing
  - ~ Demand and non-demand modes of operation
- Patient information capturing
  - ~ Stores both patient and device data at each event
  - ~ Real-time clock provides time stamps for events

- ~ Provides operator review of stored events for printout or transmission
- ~ Captures up to 360 minutes of continuous ECG data
- ~ Continuous printing of ECG data
- Patient signal monitoring
  - ~ ECG monitoring — displays up to three ECG waveforms simultaneously
  - ~ Pulse oximetry (SpO2) monitoring (continuous numeric and waveform display)  
**NOTE:** SpO2 numeric display will be replaced by SpCO and/or SpMet reading if one or both parameters are above alarm threshold.
  - ~ Heart rate/pulse rate monitoring (continuous numeric display)
  - ~ Noninvasive blood pressure (NIBP) monitoring (numeric display)
  - ~ Invasive pressure (IP) monitoring (continuous numeric and waveform display)
  - ~ Capnography (CO2 and RR) monitoring (continuous numeric and waveform display)
  - ~ Carboxyhemoglobin (SpCO) monitoring (continuous numeric is displayed when parameter is over alarm threshold)  
Note: numeric display will revert to SpO2 reading when alarm condition is canceled.
  - ~ Methemoglobin (SpMet) monitoring (continuous numeric is displayed when parameter is over alarm threshold) Note: numeric display will revert to SpO2 reading when alarm condition is canceled.
  - ~ Vital Signs Trend — Vital signs can be displayed graphically for time ranges up to 8 hours.
  - ~ ST Trend — 12-lead ECG ST measurements can be displayed graphically for time ranges up to 8 hours.
  - ~ Temperature monitoring (numeric display). This feature is only available in V2-equivalent devices.
- 12-lead ECG capture and analysis
  - ~ Acquires, analyzes, and automatically prints 12-lead data
- Alarms and warnings management
  - ~ Ventricular fibrillation/ventricular tachycardia monitoring and alarm
  - ~ Places alarm limits on patient monitoring parameters
  - ~ Automatic alarm limit reset at operator request
  - ~ Activates or suspends alarms and stores alarm events
  - ~ Silences alarms for up to 15 minutes
  - ~ Visual indicators and audible tones in alarm conditions

Service features include calibration and diagnostic functions.

### Assemblies

The device consists of a two-piece case assembly that encloses the following:

Printed Circuit Boards (when fully configured with options)

- A01 System PCB
- A03 Power PCB
- A04 Therapy PCB
- A05 Interface PCB
- A06 OEM PCB
- A07 Contact PCB
- A08 Backlight PCB
- A16 SpO2 Module
- A21 NIBP Module
- A22 Biphasic Module
- A23 CO2 Module



### Subassemblies and Wire Harnesses

- A09 Printer Control Keypad
- A10 Main Keypad
- A11 LCD Assembly
- A12 Printer Assembly
- A13 Transfer Relay Assembly
- A14 Inductive Resistor
- A15 Energy Storage Capacitor
- A17 Interconnect Bracket
- W07 ECG Connector Cable
- W08 System Connector Cable
- W09 Auxiliary Connector Cable
- W11 Therapy Connector Cable
- W15 Speed Dial Assembly
- W17 Speaker Assembly
- W22 SpO2 Connector Cable
- W28 CO2 Inlet Connector Cable
- W33 Invasive Pressure Cable
- W35 Temperature Cable

See the [Interconnect Diagram \(Figure 11.2 on p. 490\)](#)—shows detailed assembly and cable interconnect information and provides [links to each part diagram. \(p. 488\)](#).

### Physical Description and Features

Refer to this topic for a description and list of features for the following:

- [Front Panel \(p. 55\)](#)
- [Rear Panel \(p. 62\)](#)
- [What Is Shipped with a Basic Device \(p. 64\)](#)

### Front Panel

This section provides information about buttons, indicator LEDs, and connectors on the front panel. Select the area to view on [Figure 3.1 on p. 55](#)

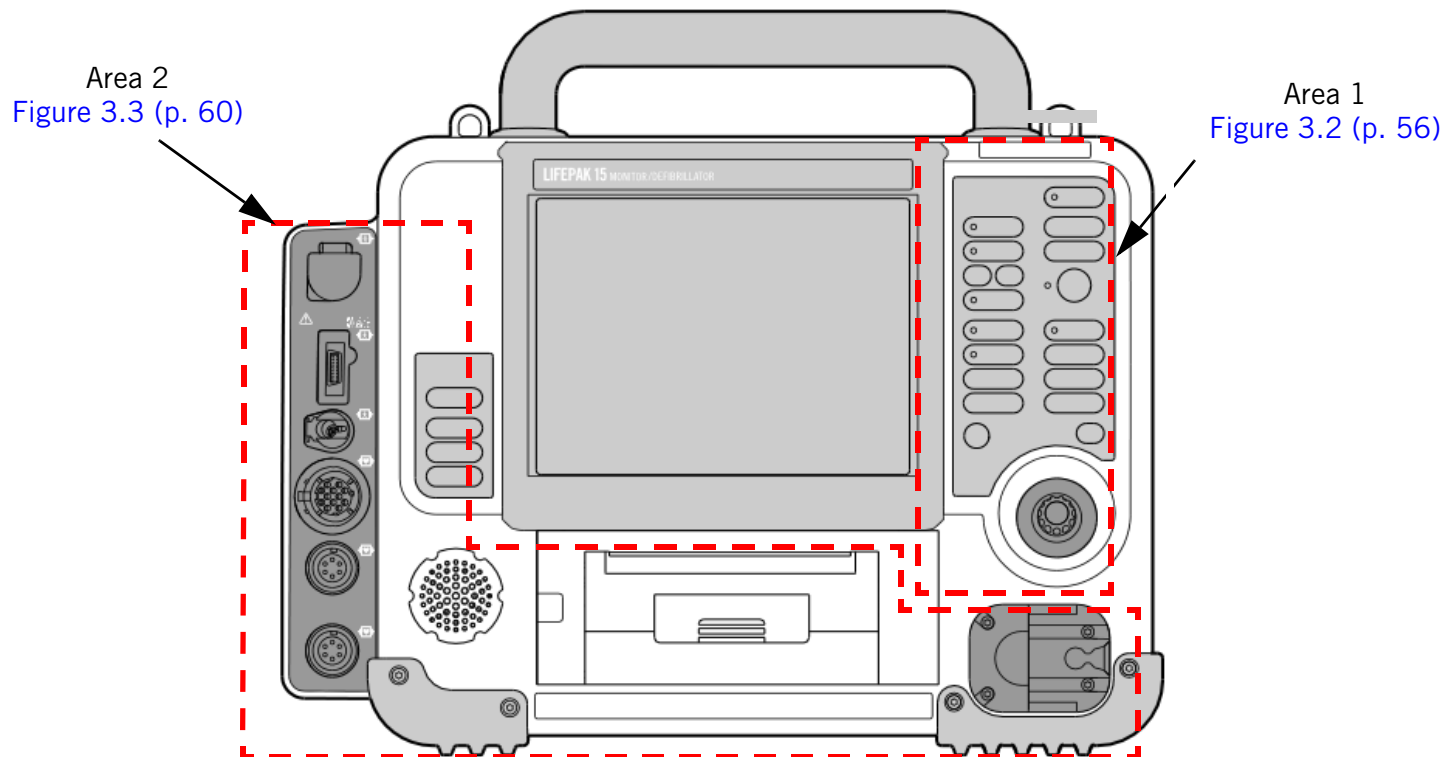

Figure 3.1—Front panel

Click the appropriate number below to view a description of that feature. See area 2 in [Figure 3.3 \(p. 60\)](#).

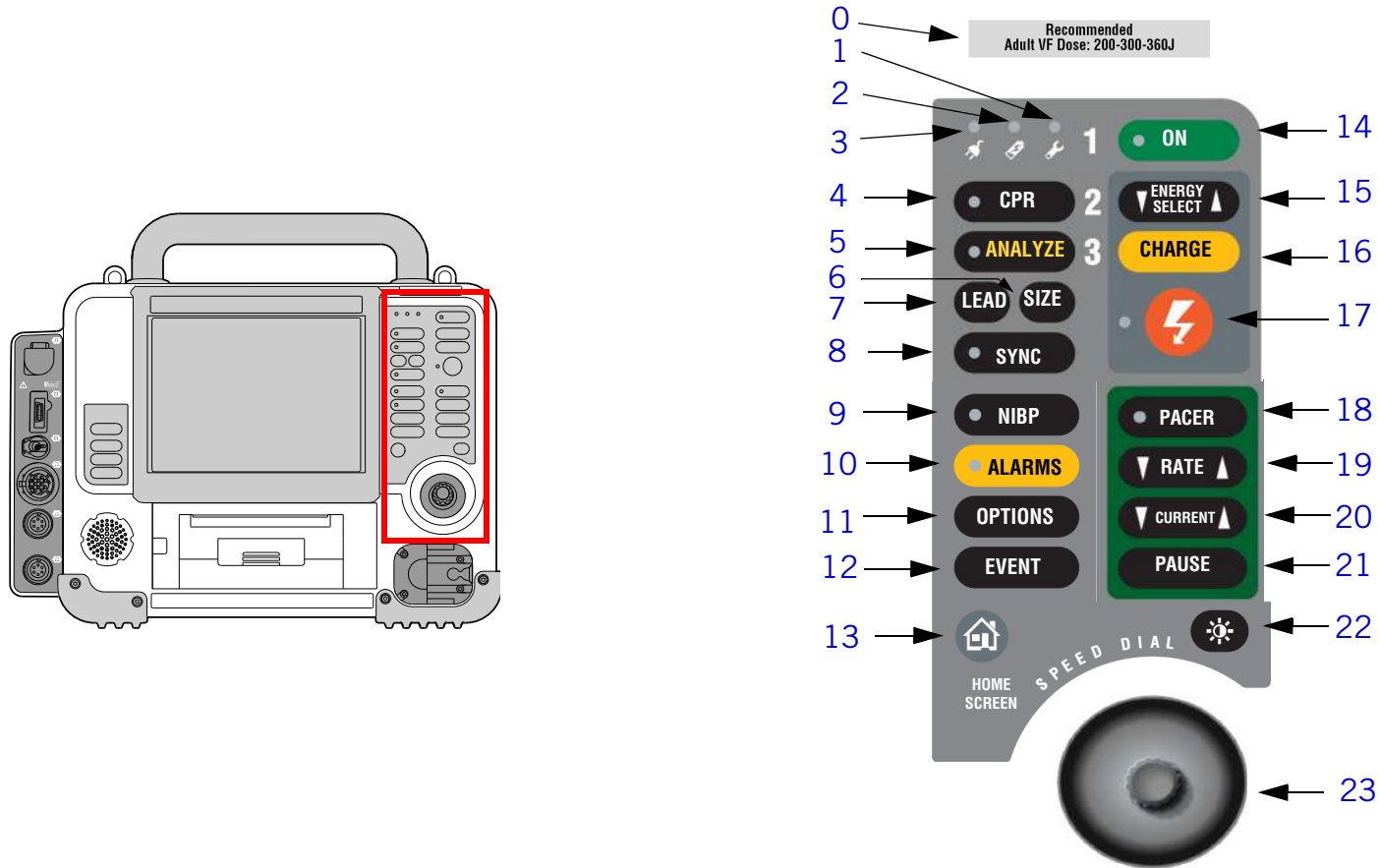

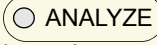

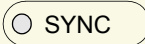
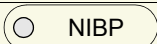
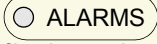

Figure 3.2—Front panel area 1

**Table 3.1— Front Panel Area 1 Features**

Number	Description
0	VF dose label — Physio-Control recommended energy dose for adult Ventricular Fibrillation (VF)
1	 Service LED — Illuminates when service error codes are written into the Service Log (accessed in the Service/Status menu, see <a href="#">Displaying the Service/Status Submenu (p. 226)</a> ). See <a href="#">Troubleshooting (p. 218)</a> for information about error codes.
2	Battery charging indicator (V2 only) - LED illuminated when installed batteries are fully charged. LED flashes when either battery is charging. LED is not illuminated when no batteries are installed or a battery is unable to be charged.
3	Auxiliary power indicator (V2 only) - LED illuminated when defibrillator is connected to auxiliary AC or DC power source, whether defibrillator is turned on or off.
4	 button and LED — Controls CPR metronome. LED is illuminated when metronome function is active.
5	 button and LED — Activates the Shock Advisory System (SAS) in AED mode. The LED is illuminated when the SAS is active and flashes when user is prompted to press <b>ANALYZE</b> .
6	 button — Changes ECG size.
7	 button — Changes ECG lead or lead set.
8	 button and LED — Activates synchronized cardioversion in Manual mode. The LED is illuminated when active. When synchronized, the LED flashes with each detected QRS complex.
9	 button (optional) — Initiates blood pressure measurement. LED is illuminated when BP measurement is being obtained.
10	 button and LED — Open alarms menu or silences alarms. The LED is illuminated when alarms are enabled and flashes when an alarm condition occurs.

**Table 3.1— Front Panel Area 1 Features (Continued)**







Number	Description
11	 <b>OPTIONS</b> button — Accesses optional functions. The options menu selections are: PATIENT, PACING, DATE/TIME, ALARM VOLUME, ARCHIVES, PRINT, and USER TEST.
12	 <b>EVENT</b> button — Accesses pre-defined and user-defined events.
13	 <b>HOME SCREEN</b> button — Returns to Home Screen display or to previous menu.
14	 <b>ON</b> button and LED — Turns device ON or OFF. LED illuminated when ON. Press and hold to turn device off.
15	 <b>ENERGY SELECT</b> button — Increase or decrease defibrillator energy level in Manual mode. Energy levels are from 2 joules to 360 joules.
16	 <b>CHARGE</b> button — Charges the defibrillator in Manual mode. QUIK-COMBO or hard paddles must be attached. When operating with hard paddles, use the <b>CHARGE</b> button on the <b>APEX</b> paddle. If the device is in pacing mode, pressing this button deactivates Pacing Mode and charges the device.
17	 <b>SHOCK</b> button and LED — Initiates discharge of defibrillator energy in either AED mode or Manual mode. The LED flashes when the device is fully charged. When operated with hard paddles, pressing both <b>SHOCK</b> buttons on the paddles discharge energy.
18	 <b>PACER</b> button and LED — Activates pacer function. LED illuminated when function is activated and flashes with each current pulse.
19	 <b>RATE</b> button — Increases or decreases pacing rate. The up or down arrows on button adjusts the pacing rate in 10 ppm increments, or rotate the <b>SPEED DIAL</b> to change the rate in 5 ppm increments.
20	 <b>CURRENT</b> button — Increases or decreases pacing current. The up or down arrows on button adjusts the pacing current in 10 mA increments, or rotate the <b>SPEED DIAL</b> to change the current in 5 mA increments.

Table 3.1— Front Panel Area 1 Features (Continued)

Number	Description
21	 button — Temporarily slows pacing rate to 25% of the set rate. While pressed, PAUSED appears before PPM at the bottom of the screen. Release to resume pacing at the set rate.
22	 DISPLAY MODE button — Switches between color display and high contrast SunVue™ display.
23	 SPEED DIAL — Scrolls through and selects screen or menu items.

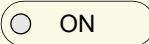
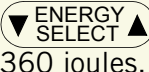
Click the appropriate number to view a description of that feature.

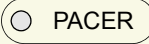
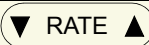
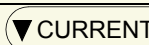
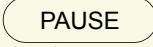
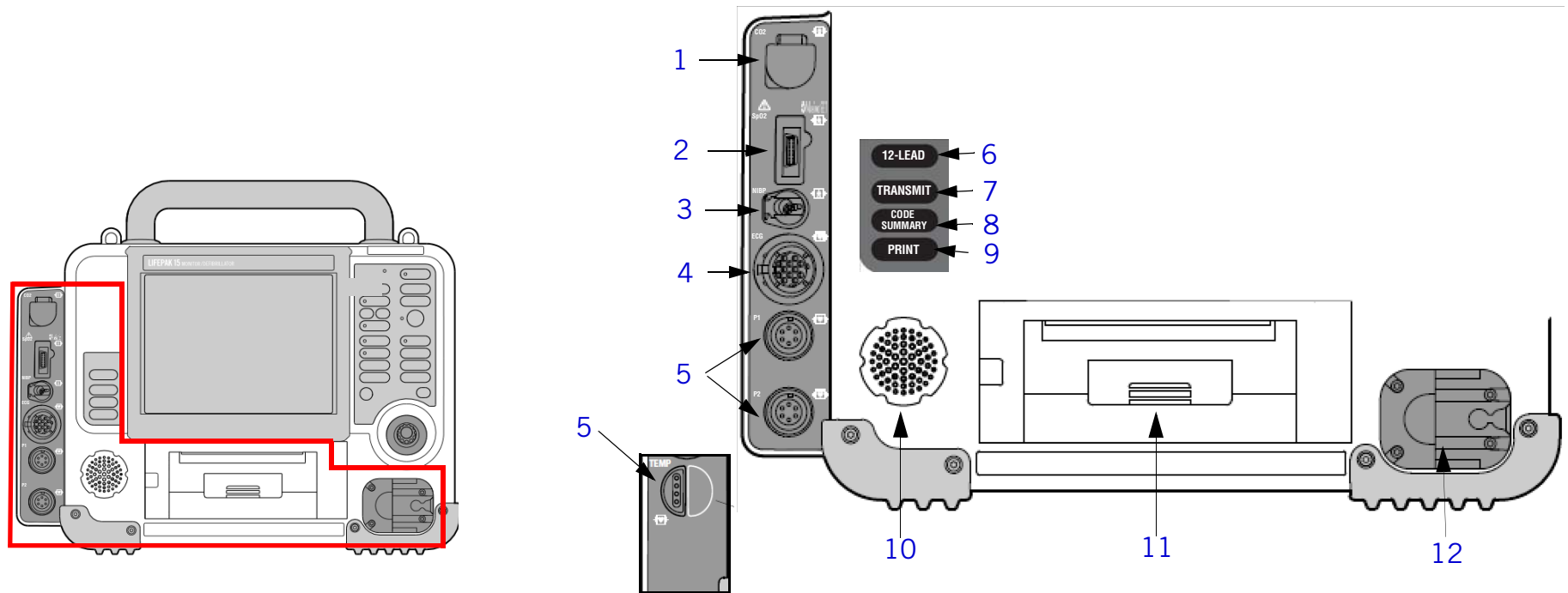
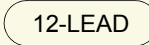
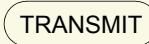



Figure 3.3—Front panel area 2



**Table 3.2— Front Panel Area 2 Features**

Number	Description
1	CO2 FilterLine® set port (optional) — Intake port for the CO2 monitor, which continuously measures the amount of CO2 during each breath and reports the amount present at the end of exhalation (CO2).
2	SpO2/SpCO/SpMet sensor cable port (optional) — Connection port for the pulse oximeter, which noninvasively checks the saturation of oxygen, carboxyhemoglobin concentration, and methemoglobin concentration in arterial blood.
3	NIBP pneumatic tubing port (optional) — Port for connection to the blood pressure tubing which connects to the cuff. NIBP measures the blood pressure of the adult or pediatric patient.
4	ECG cable port — Connection port for the electrically isolated ECG patient cable. Cable configurations include the 12-lead cable with limb lead and precordial lead attachments, 5-wire, and 3-lead cables.
5	IP cable ports — P1 and P2 connection ports for invasive pressure cables, which invasively measure arterial blood pressures, central venous pressure (CVP), or intracranial pressure. Note: If device is configured for temperature monitoring, P1 and P2 are replaced by a single port labeled TEMP.
6	 button (optional) — Initiates acquisition, analysis, storage, and printing of a 12-lead ECG report.
7	 button — Initiates transmission of patient data to another location through direct connect serial, gateway, or wireless connection.
8	 button — Prints a summary of the current patient documentation, including vital signs and waveforms.
9	 button — Prints a continuous ECG stripchart. Press again to stop printing.
10	Speaker — Projects device tones and voice prompts.
11	Printer — Prints displayed waveforms, CODE SUMMARY, and other reports.
12	Therapy cable receptacle — Connection point for QUIK-COMBO therapy cable and hard paddles.

### Rear Panel

This section provides information about features on the rear panel.

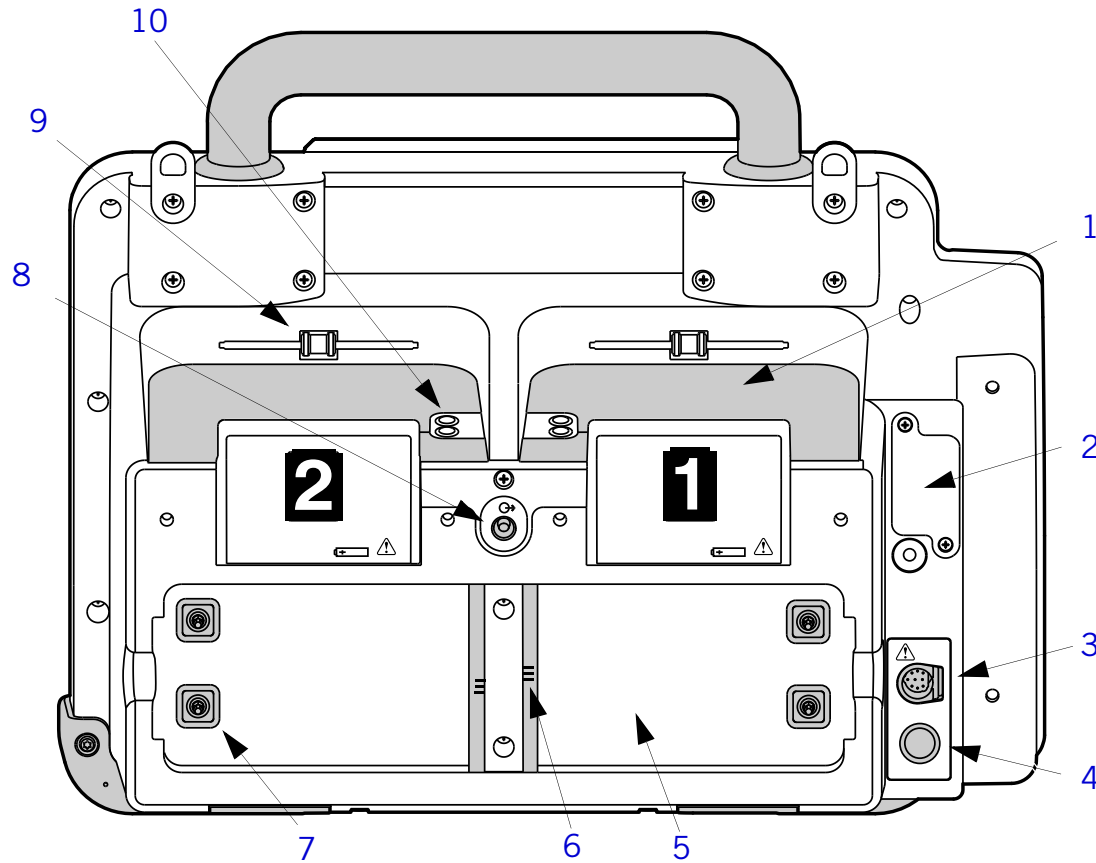

Figure 3.4—Rear features diagram

**Table 3.3— Rear Panel Features**

Number	Description
1	Hard paddle wells — Storage area for a set of hard paddles.
2	USB port cover — Protects USB port from the environment.
3	System connector — Connects device to a gateway or external computer for transfer of patient reports. Also provides real-time ECG output.
4	Auxiliary connector — Connection port for an external power adapter.
5	Battery compartments — Accommodate two removable Lithium-ion batteries that provide power for the LIFEPAK 15 monitor/defibrillator.
6	Battery contacts — Transfer battery status information.
7	Battery pins — Two pins in each battery compartment transfer the battery power.
8	CO2 exhaust port (optional) — Vents gasses from CO2 monitor.
9	Paddle retainers — Provide secure retention and quick removal of paddles.
10	Paddle test contacts — Allow complete paddles defibrillation checks.

### What Is Shipped with a Basic Device

A basic device includes the components shown below.

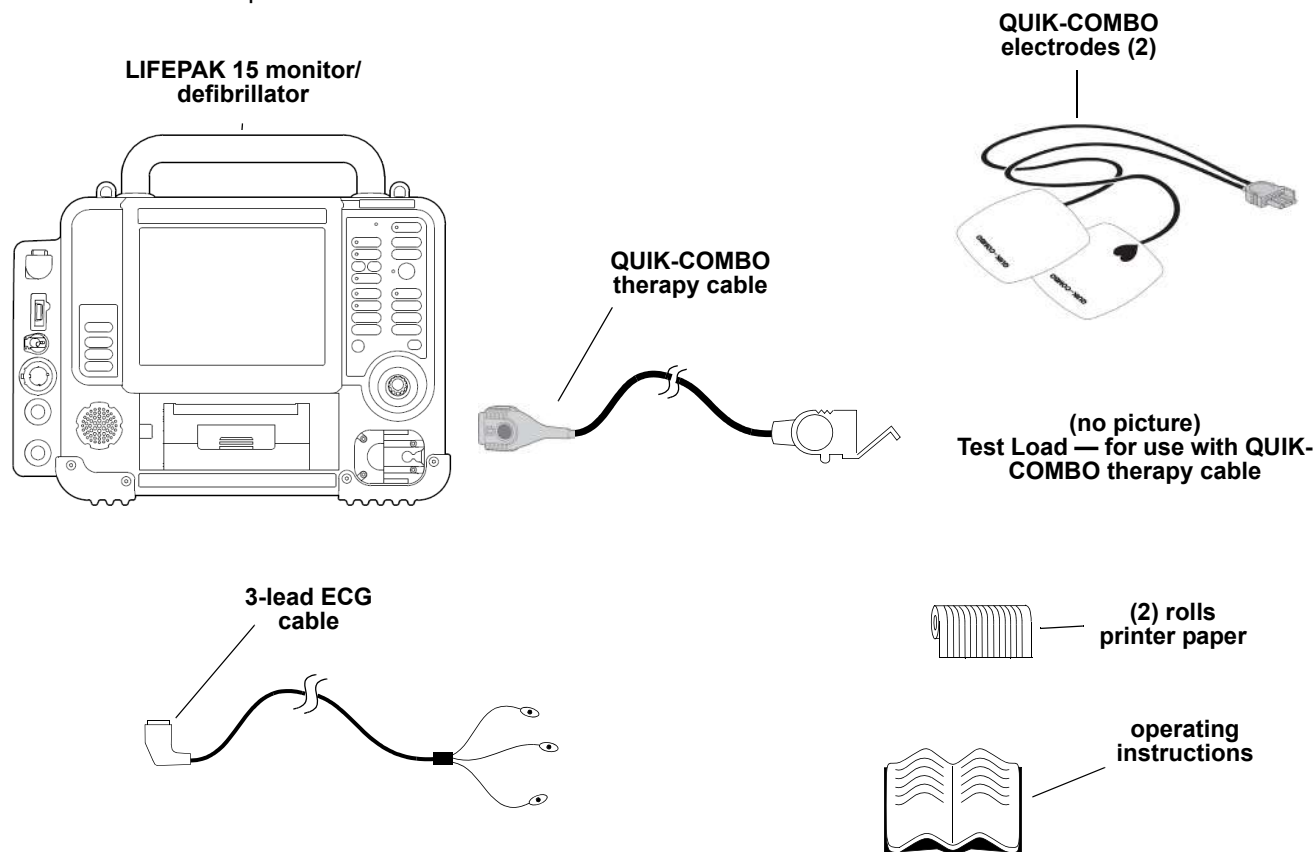

Figure 3.5—Components of the basic device

## Devices, Options, Supplies, and Accessories

The following table, provided for reference, summarizes optional configurations, supplies, and accessories that are available. For up-to-date ordering information, contact your Physio-Control representative or order online at [store.physio-control.com](http://store.physio-control.com) (U.S. only).

**Table 3.4— LIFEPAK 15 Configurations**

Item	Description
<b>LIFEPAK 15 monitor/defibrillator</b>	
Basic device	<ul style="list-style-type: none"> <li>• 3-lead ECG cable</li> <li>• QUIK-COMBO therapy cable</li> <li>• Two sets QUIK-COMBO electrodes</li> <li>• Device operating instructions</li> <li>• 2 rolls of 100-mm printer paper</li> </ul>
<b>Optional Features</b>	
SpO2 (only)	Accessories: <ul style="list-style-type: none"> <li>• Masimo SET® Red™ or LNCS™ sensors</li> <li>• Masimo SET Red patient cables</li> <li>• Nellcor Oximax™ sensors with Masimo Red™ MNC patient cable</li> </ul>
SpO2/SpCO/SpMet	Accessories: <ul style="list-style-type: none"> <li>• Masimo SET Rainbow® sensors</li> </ul>
CO2	Accessories: <ul style="list-style-type: none"> <li>• Airway adapter</li> <li>• FilterLine®</li> <li>• CapnoLine®</li> </ul>

**Table 3.4— LIFEPAK 15 Configurations (Continued)**

Item	Description
NIBP	Accessories: <ul style="list-style-type: none"> <li>• Reusable blood pressure cuff</li> <li>• Disposable blood pressure cuff</li> <li>• NIBP hose - coiled</li> </ul>
Vital signs and ST trending	Provides graphical plot trending of vital signs or ST measurement for up to 8 hours.
Invasive Pressure	See the operating instructions for IP accessory specifications.
Temperature	Accessories: <ul style="list-style-type: none"> <li>• Disposable temperature probes</li> <li>• Temperature probe adapter cable</li> </ul>
12-lead ECG	Accessories: <ul style="list-style-type: none"> <li>• Main 4-wire cable</li> <li>• 6-wire precordial lead attachment</li> </ul>
Bluetooth	Provides wireless communication to Physio-Control data management products
<b>Optional Therapy Delivery</b>	
Hard paddles (can be used instead of QUIK-COMBO cable and electrodes for defibrillation or sync cardioversion)	Pair
Pediatric paddles (attach to hard paddles)	Two required

**Table 3.4— LIFEPAK 15 Configurations (Continued)**

Item	Description
<b>Electrodes</b>	
LIFE•PATCH ECG electrodes (for monitoring only)	Sets of 3 or 4
QUIK-COMBO multifunctional ECG electrodes with EDGE System™ technology	<ul style="list-style-type: none"> <li>• Standard — one pair</li> <li>• Radio transparent system (RTS) — one pair</li> <li>• RTS, pediatric — one pair</li> <li>• REDI-PAK™ preconnect system — one pair</li> </ul>
<b>Power Options</b>	
Batteries (two per device)	<ul style="list-style-type: none"> <li>• Rechargeable Lithium-ion (with fuel gauge)</li> </ul>
LIFEPAK 15 monitor/defibrillator Station or Mobile Li-ion Battery Charger	<ul style="list-style-type: none"> <li>• AC power cord (country/region specific)</li> <li>• DC power cable (Mobile Charger only)</li> <li>• Mounting bracket with 4 (8-32 x 0.5”) screws, 4 lock washers, and template</li> </ul>
REDI-CHARGE™ Li-ion Battery Charging System	<ul style="list-style-type: none"> <li>• LIFEPAK 15 Li-ion battery adapter tray</li> <li>• AC power cord (country/region specific)</li> </ul>
LIFEPAK 15 monitor/defibrillator AC power adapter	<ul style="list-style-type: none"> <li>• AC power cord (country/region specific)</li> <li>• Power adapter output cable</li> <li>• Optional - output extension cable</li> </ul>
LIFEPAK 15 monitor/defibrillator DC power adapter	<ul style="list-style-type: none"> <li>• DC power cord (unterminated)</li> <li>• Power adapter output cable</li> <li>• Optional - output extension cable</li> </ul>

**Table 3.4— LIFEPAK 15 Configurations (Continued)**

Item	Description
<b>Data Management and Communications</b>	
Cables	<ul style="list-style-type: none"> <li>• Device-to-PC serial interface cable (connects to serial port on a PC or other equipment)</li> <li>• Device-to-PC USB interface cable (connects to USB connector on a PC or other equipment)</li> <li>• Analog ECG output cable (used to monitor ECG waveforms on external equipment)</li> </ul>
PC software	<ul style="list-style-type: none"> <li>• CODE-STAT™ Reviewer, version 8.0 (minimum version required)</li> <li>• DT EXPRESS™ 3.0 Data Transfer Software</li> </ul>
<b>Training and Testing Tools</b>	
Patient simulators	<ul style="list-style-type: none"> <li>• QUIK-COMBO, 3-lead</li> <li>• QUIK-COMBO, 12-lead (used with 12-lead ECG feature)</li> </ul>
Testers	<ul style="list-style-type: none"> <li>• Defibrillation checker for hard paddles</li> <li>• Test Load — for use with QUIK-COMBO therapy cable only</li> </ul>
<b>Technical Manuals</b>	
Operating instructions	<ul style="list-style-type: none"> <li>• Printed, one included per device</li> </ul>
Service manual	<ul style="list-style-type: none"> <li>• CD-ROM</li> </ul>
<b>Carrying Bags</b>	
Carrying bags	<ul style="list-style-type: none"> <li>• Basic carrying bag system — device only (includes left and right bags) with shoulder strap</li> <li>• Shoulder strap</li> <li>• Rear bag — (screws into back of device)</li> <li>• Paddle well bag</li> </ul>



Table 3.4— LIFEPAK 15 Configurations (Continued)

Item	Description
<b>Supplies</b>	
Printer paper	<ul style="list-style-type: none"><li>• 100-mm printer paper — box of 2 rolls</li></ul>
SIGNAGEL <sup>®</sup> electrode gel	<ul style="list-style-type: none"><li>• Use with hard paddles</li></ul>

### System Context Diagrams

Refer to this section to view diagrams of how the major parts of the system are connected. The diagrams include the following:

- [Front of Device \(p. 71\)](#)
- [Device Communication \(p. 73\)](#)

### Front of Device

The following diagrams illustrate how the device connects to external accessories.

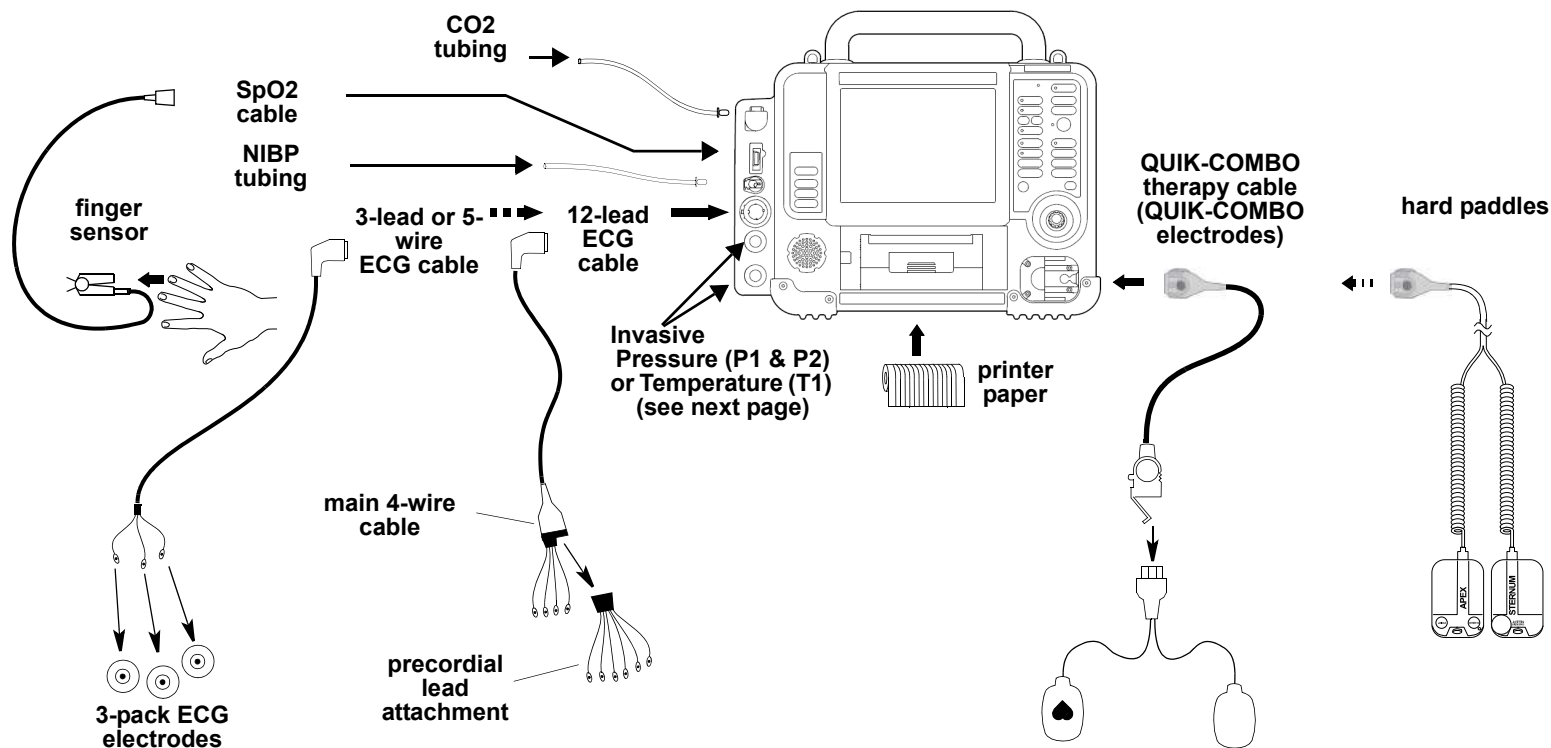

Figure 3.6—Device connections with external equipment and accessories

The following diagram illustrates how the device connects to invasive pressure or temperature equipment.

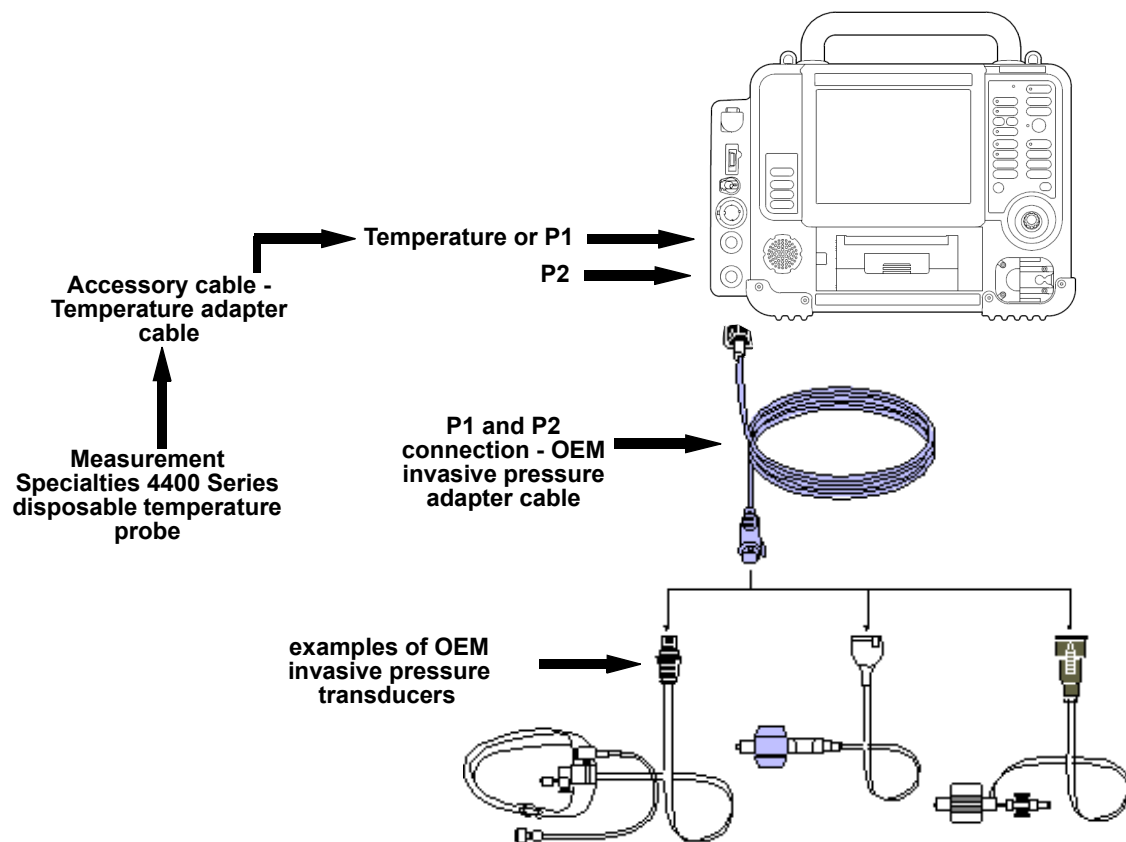

Figure 3.7—Device connection with invasive pressure or temperature equipment

### Device Communication

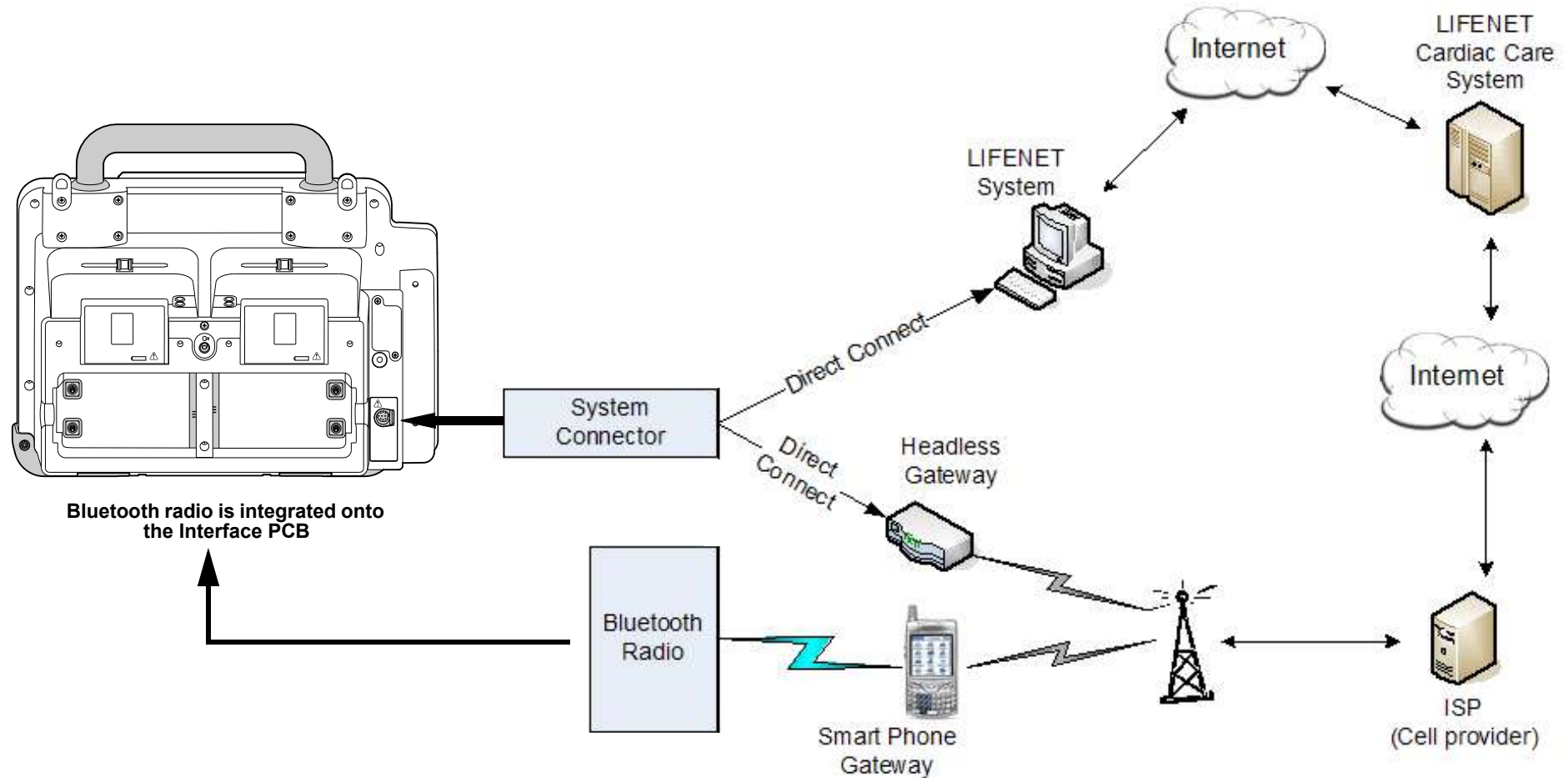

Figure 3.8—Device system connector

## Functional Descriptions

The LIFEPAK 15 monitor/defibrillator (device) is a platform medical device capable of combining a variety of therapeutic and monitoring features. In addition to manual defibrillation, semiautomatic defibrillation, and noninvasive pacing, the device offers optional oximetry, invasive pressure, noninvasive blood pressure, CO<sub>2</sub>, 12-lead ECG, and temperature monitoring. A key feature of the device is its ability to be upgraded as the needs of the customer change or as new features become available. This portable device is powered by two Lithium-ion batteries.

The functional descriptions that follow provide a basic understanding of the device design and assist the qualified service technician in troubleshooting to the subassembly level. Troubleshooting below the subassembly level, outside the factory, is not recommended, nor is it within the scope of this service manual to provide the detail necessary to support such repairs.

See the system block diagram ([Figure 3.9 on p. 76](#)) when necessary as you review the following functional descriptions.

- [System PCB \(A01\) \(p. 77\)](#)
- [Power PCB \(A03\) \(p. 79\)](#)
- [Therapy PCB \(A04\) \(p. 80\)](#)
- [OEM PCB \(A06\) \(p. 83\)](#)
- [Contact PCB \(A07\) \(p. 84\)](#)
- [Backlight PCB \(A08\) \(p. 84\)](#)
- [Printer Control Keypad \(A09\)/Main Keypad \(A10\) \(p. 84\)](#)
- [LCD Assembly \(A11\) \(p. 84\)](#)
- [Printer Assembly \(A12\) \(p. 84\)](#)
- [Transfer Relay Assembly \(A13\) \(p. 85\)](#)
- [Inductive Resistor \(A14\) \(p. 85\)](#)
- [Energy Storage Capacitor \(A15\) \(p. 85\)](#)
- [SpO<sub>2</sub>/SpCO/SpMet Module \(A16\) \(p. 85\)](#)
- [Interconnect Bracket \(A17\) \(p. 85\)](#)
- [NIBP Module \(A21\) \(p. 86\)](#)
- [Biphasic Module \(A22\) \(p. 86\)](#)
- [CO<sub>2</sub> Module \(A23\) \(p. 86\)](#)

- [ECG Connector Cable \(W07\) \(p. 86\)](#)
- [System Connector Cable \(W08\) \(p. 86\)](#)
- [Therapy Connector Cable \(W11\) \(p. 87\)](#)
- [Speed Dial Assembly \(W15\) \(p. 87\)](#)
- [Speaker Assembly \(W17\) \(p. 87\)](#)
- [SpO2 Connector Cable \(W22\) \(p. 87\)](#)
- [CO2 Inlet Connector Cable \(W28\) \(p. 88\)](#)
- [IP Connector Cable \(W33\) \(p. 88\)](#)
- [Temperature Connector Cable \(W35\) \(p. 88\)](#)

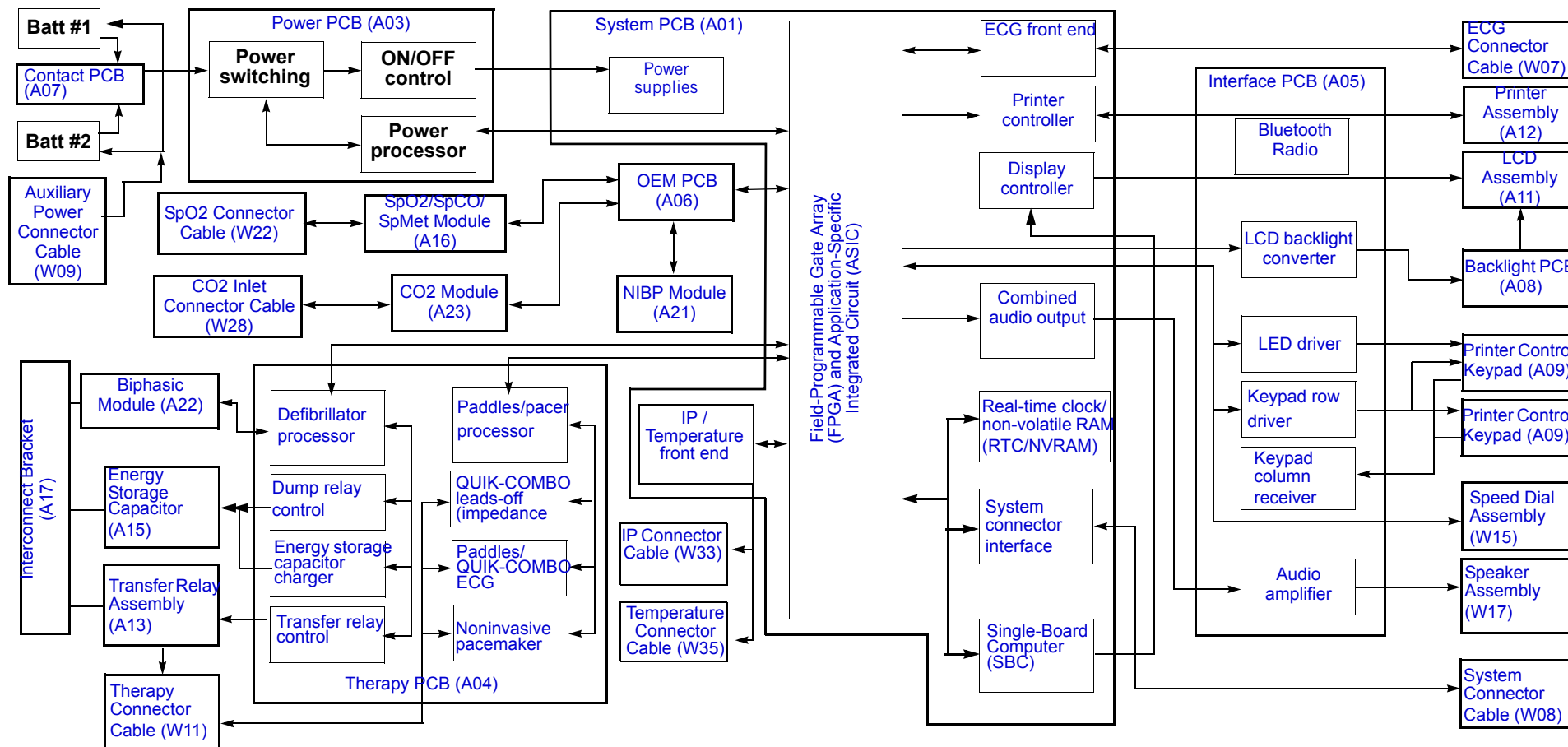

Figure 3.9—System block diagram



### System PCB (A01)

The A01 System PCB integrates and controls all functions of the device. There are two primary components:

#### Single-Board Computer (SBC)

The single board computer (SBC) functions as the central processing unit (CPU) for intensive number-processing tasks.

#### Field-Programmable Gate Array (FPGA) and Application-Specific Integrated Circuit (ASIC)

The field-programmable gate array (FPGA) and application-specific integrated circuit (ASIC) operate as the interface between the CPU and all other therapeutic, monitoring, data management, and display device subsystems.

The following items identify the major subsystems of the A01 System PCB and their basic functions.

#### Power supplies

The A01 System PCB uses SW\_VB (switched battery voltage) from the A03 Power PCB (via the A04 Therapy PCB) to originate six power supplies for use throughout the device as follows:

- ~ +1.5 V power for use on the FPGA.
- ~ +1.8 V power for use on the SBC.
- ~ +5 V logic power for use on the A01 System PCB within the DUART, RTC, ASIC, and audio subsystems, and the A04 Therapy PCB.
- ~ +3.3 V logic power for use on the A01 System PCB within the SBC and FPGA CPUs, DSP, main, and ASIC subsystems.
- ~  $\pm 12$  V analog power for use on the A01 System PCB and A04 Therapy PCB.
- ~ +24 V power for use in the A01 System PCB printer subsystem.

#### ECG front end

The device simultaneously captures inputs from up to 10 independent patient-connected leads for use in the interpretive 12-lead algorithm and ECG waveform display. The ECG front end performs the functions of patient isolation, electrostatic discharge and defibrillation protection, lead selection, baseline dc restore, bandwidth filtering, internal pacemaker

detection, and ECG sampling via analog-to-digital conversion (ADC). Results from the ADC process pass across the isolation barrier to the A01 System PCB digital signal processor (DSP) for filtering and signal conditioning before being used by the SBC CPU. ECG input is through the parameter bezel W07 ECG Connector Cable.

#### IP / Temperature front end

The invasive pressure (IP) circuitry processes the input signal from a disposable IP transducer through the IP input connectors on the device parameter bezel. Two input connectors are provided for simultaneous monitoring of two IP channels. The W33 Invasive Pressure Harness provides the connection from the parameter bezel to the A01 System PCB, where the IP/temp preamplifier circuitry is located.

The IP/temp preamplifier is isolated from the AC power ground by the ECG preamplifier iso-barrier. The transducer drive circuitry supplies a positive 2.5 V and a negative 2.5 V excitation voltage to the resistive bridge-type transducer. The output signal from the transducer is conditioned by a low-pass filter at the input of an instrumentation amplifier, which amplifies the signal approximately 400 times. The signal is then multiplexed to the A-D converter, digitized, and then sent serially across the iso-barrier for DSP processing and display.

The temperature circuitry processes the input signal from a disposable temperature probe through the external adapter cable. The temperature adapter cable connects to the connector below the ECG connector on the parameter bezel. The W35 temperature connector cable provides the connection from the parameter bezel to the A01 System PCB.

#### Printer controller

The device uses a 100-mm thermal array printer. The A01 System PCB printer controller governs motor speed, adjusts print strobe pulse width, senses paper presence and door closure, senses printhead temperature, and provides the data to be printed. Printer fonts are stored in memory devices located on the A01 System PCB.

#### Real-time clock/non-volatile RAM (RTC/NVRAM)

The RTC/NVRAM maintains the date and time and provides storage for device user setups. The RTC/NVRAM is powered by a lithium coin cell battery.

### System connector interface

The device can be connected to external equipment for transmitting analog ECG signal output, data transmission, factory test, Physio-Control field service data collection, and device configuration during field upgrade. Except for analog ECG signals, all data communication at the system connector is at RS-232 levels.

The analog ECG signal output path consists of A01 System PCB components, including a digital-to-analog converter (DAC), low-pass filter, and electrostatic discharge protection.

The digital communications output path consists of the following two components:

- ~ Dual universal asynchronous receiver/transmitter (DUART)
- ~ Level-shifter, used for converting device internal logic levels to RS-232 levels.

### Display controller

Data for display on the device A11 LCD assembly originates from the A01 System PCB Display Controller made up of a portion of the SBC and dedicated data driver/buffers. Screen fonts are stored in memory devices located on the A01 System PCB.

### Combined audio output

Originates from the A01 System PCB ASIC. System audio (voice prompts and alarm tones) from the ASIC returns to analog form in an A01 System PCB DAC. System audio is filtered and routed to the A05 Interface PCB audio amplifier for application to the W17 Speaker Assembly. Voice prompts are stored in memory devices located on the A01 System PCB.

## Power PCB (A03)

The A03 Power PCB manages application of power to the device from the two Li-ion batteries. Additional functions include power on/off control, “smart” battery communication, routing battery charge currents, battery voltage measurement, over-current protection fusing, and serial communication of power status to the A01 System PCB.

A03 Power PCB operation centers around a power processor, which detects the presence of available power sources, selects a power source for use by the device, and monitors their status (for example, low battery, replace battery, removal from the device, etc.) and can apply charging currents from an attached power adapter to the batteries when connected.

When the device is OFF, closure of the device power control activates A03 Power PCB circuitry to alert the power processor, which chooses the appropriate source to originate SW\_VB (switched battery voltage) power. SW\_VB is then routed, in turn, to the A04 Therapy PCB and A01 System PCB for use, as is, and for further processing into system power supply voltages.

Closure of the power control when the device is ON triggers an orderly device shutdown prior to turning off SW\_VB.

### Therapy PCB (A04)

The A04 Therapy PCB maintains the patient interface for therapeutic purposes. In addition to developing defibrillation and noninvasive pacing energies, the A04 Therapy PCB ensures safe delivery of those energies, captures ECG paddles, and monitors attachment of the QUIK-COMBO electrodes.

The major subsystems of the A04 Therapy PCB and their basic functions are as follows:

#### Defibrillator processor

The defibrillator processor manages the defibrillator energy storage and delivery functions using serial inputs from the A01 System PCB ASIC, hardware inputs from external paddles, and inputs from other A04 Therapy PCB circuitry. Status of the defibrillator subsystem is reported serially to the A01 System PCB ASIC.

#### Energy storage capacitor charger (ESCC)

Under control of the defibrillator processor, the ESCC converts COM\_VB (common battery voltage) to high voltage for application to the energy storage capacitor. Circuitry within the ESCC performs comparisons between stored energy and target energy to limit charging to the value selected by the user. Additional circuits compensate the ESCC for low battery voltage, provide over-voltage protection, and send divided capacitor high voltages to separate safety monitoring and energy display circuits.

#### Transfer relay control

To enable the transfer of defibrillation energy, the A04 Therapy PCB integrates control signals from the SHOCK button (or external paddles' SHOCK buttons), defibrillator processor, ESCC, and the A01 System PCB ASIC. The transfer relay will be activated only to deliver energy to the defibrillation electrodes when all conditions are satisfied in each system component.

#### Dump relay control

A fail-safe system used to safely dissipate defibrillation energies from the energy storage capacitor under a number of circumstances (for example, change of energy selection, power removal, pacing activation, and QUIK-COMBO leads-off). With the exception of power removal, the dump relay control system functions under the control of the system and/or defibrillator processors.

#### QUIK-COMBO leads-off (impedance sense/motion detection)

With the QUIK-COMBO electrodes applied and the device in AED mode, leads-off/motion detection circuits are active. Only leads-off is active when device is in Manual mode and QUIK-COMBO electrodes applied.

For purposes of this discussion, consider the leads-off/motion detector and patient system as a simple voltage divider.

Leads-off/motion detection relies on two main characteristics:

- ~ Leads-off/motion detector output impedance is relatively high (greater than 125 k $\Omega$ ).
- ~ Patient impedance is relatively low (typically less than 30  $\Omega$ ).

To exploit these characteristics, the device injects an ac impedance drive signal through the QUIK-COMBO electrodes into the relatively low patient impedance and monitors the voltage drop across the patient. Minute perturbations sensed in the low-amplitude signal developed across the patient represent motion; gross changes in the sensed signal indicate electrode disconnection.

#### Paddles/QUIK-COMBO ECG preamplifier

The ECG paddles/QUIK-COMBO ECG preamplifier perform the functions of patient isolation, electrostatic discharge and defibrillation protection, baseline dc restore, bandwidth filtering, internal pacemaker detection, and ECG sampling through analog-to-digital conversion (ADC). Results from the ADC process are fed to the paddles/pacer processor.

#### Paddles/pacer processor

The paddles/pacer processor controls all facets of noninvasive pacemaker operation and paddles ECG signal acquisition. Inputs received serially from the A01 System PCB ASIC are translated into controls to enable noninvasive pacemaker delivery of properly timed pacing impulses at the desired current. Analog ECG from the Paddles/QUIK-COMBO ECG Preamplifier is processed for local use and for transfer across the isolation barrier to the A01 System PCB DSP and onto the A01 System PCB ASIC.

#### Noninvasive pacemaker

The A04 Therapy PCB noninvasive pacemaker subsystem develops isolated, adjustable current, 20-millisecond (nominal), trapezoidal transchest pacing impulses. Major components of the noninvasive pacemaker include the paddles/pacer processor, isolated low- and high-voltage power supplies, safety monitors, output current, pulse width, and pulse shape controls. Controls for, and status of, the noninvasive pacemaker pass serially between the paddles/pacer processor and the A01 System PCB ASIC.

### Interface PCB (A05)

The A05 Interface PCB is primarily a signal collector/distributor used to simplify the routing of cables between the front and rear halves of the device. The majority of signals from the device rear half are consolidated into the W04 System PCB/Interface PCB Cable and passed to the A05 Interface PCB for further distribution to front half components (for example, A09 Printer Control Keypad, A10 Main Keypad, A11 LCD Assembly, and A12 Printer Assembly). The following active circuits reside on the A05 Interface PCB:

#### Audio amplifier

Combined audio output signals receive final amplification in the A05 Interface PCB Audio Amplifier prior to application to the W17 Speaker Assembly.

### LED driver

Most device LEDs (located on the A10 main keypad) receive their drive from a serial-to-parallel converter located on the A05 Interface PCB. The Service LED drive originates from the A01 System PCB ASIC. The CHARGE and Power ON LEDs receive their drive from the A03 Power PCB Power Processor.

### Keypad row driver

The A01 System PCB ASIC reads device control buttons using a row and column address scheme (that is, each button resides at a unique row and column address). Data from the ASIC shifts serially into the A05 Interface PCB Keypad Row Driver (a serial-to-parallel converter) for application to button rows in the A09 printer control keypad and A10 main keypad. A button closure enables row drive for a unique button to be sensed at the keypad column receiver.

### Keypad column receiver

The A01 System PCB ASIC reads button closures serially from the Interface keypad column receiver (a parallel-to-serial converter). In practice, closure of a device button passes row drive for that button to one, and only one, column receiver input.

### LCD backlight converter

The A05 Interface PCB applies filtered SW\_VB through a Boost Converter to apply a minimum of 9.6 V to the A08 Backlight PCB when it receives an enable signal (LCD\_BL\_ON) from the A01 System PCB display controller. A separate backlight power supply is mounted on a metal bracket in the front case.

### Bluetooth Radio

Bluetooth radio is integrated onto the Interface PCB. You can transmit current and archived data from the LIFEPAK 15 device to the LIFENET® System or to post-event review products such as CODE-STAT™ or DT EXPRESS™ software.

## OEM PCB (A06)

A PCB used to integrate monitoring modes supplied to Physio-Control by third parties, or original equipment manufacturers (OEMs), into the device system architecture. The A06 OEM PCB provides isolated power supplies, safety isolation, transient protection, and signal interface adapters to support hosted OEM modules.

### Contact PCB (A07)

Interfaces the Li-ion battery edge connector with the device and provides I2C communication to and from the battery. In addition, the device uses a battery pull signal to indicate when the battery is being removed.

### Backlight PCB (A08)

A printed circuit board that contains the circuitry to light the A11 LCD assembly screen.

### Printer Control Keypad (A09)/Main Keypad (A10)

Common device controls (those not available using the SPEED DIAL) are initiated through either the A09 printer control keypad or the A10 main keypad. The number of buttons on these keypads varies, depending on the features installed in a specific device. All buttons, with the exception of ON and SHOCK, are addressed by the user controls section of the A01 System PCB ASIC.

- The ON button remains separate from the addressed buttons because it is needed to activate and deactivate the device without ASIC interaction. Closures of the ON button are applied to the A03 Power PCB On/Off control block.
- The SHOCK button remains separate from the addressed buttons as a matter of fail-safe design, thus preventing inappropriate activation under conditions of loss of CPU control. Operator-initiated closures of the SHOCK button are applied in two places: the A01 System PCB ASIC and the A04 Therapy PCB defibrillator processor. The ultimate shock decision rests with both the ASIC and defibrillator processor agreeing to deliver defibrillation energy.

### LCD Assembly (A11)

A backlit, 640 × 480 pixel, color LCD that displays the primary and secondary ECG waveforms and text messages.

### Printer Assembly (A12)

The 100-mm printer is installed to support 12-lead ECG monitoring and printing of multiple displayed waveforms.



### Transfer Relay Assembly (A13)

A high-voltage relay mounted in the rear case that routes current from the A15 Energy Storage Capacitor, by means of the A22 Biphasic Module, through the W11 Therapy Connector Cable to the patient. Activation of the A13 Transfer Relay is governed by the A04 Therapy PCB Transfer Relay Control block.

### Inductive Resistor (A14)

A resistor that conditions the energy storage capacitor output for the wave generator/regulator circuit on the A22 Biphasic Module.

### Energy Storage Capacitor (A15)

A metallized film capacitor used for energy storage. The capacitance of the A15 Energy Storage Capacitor is calculated when you perform the TCP – Defibrillator Calibration procedure (see [TCP – Defibrillator Energy Calibration \(p. 200\)](#)). The nominal value is 195  $\mu$ F.

### SpO<sub>2</sub>/SpCO/SpMet Module (A16)

An OEM oximetry module supplied by Masimo. The module performs all functions related to oxygen, carboxyhemoglobin and methemoglobin saturation, including sensor drive. Measurement results pass serially by means of the A06 OEM PCB to the A01 System PCB ASIC for display.

### Interconnect Bracket (A17)

A terminal assembly used to interconnect the A13 Transfer Relay Assembly, A22 Biphasic Module, and A15 Energy Storage Capacitor. The bracket itself is strapped to the A15 Energy Storage Capacitor with a large cable tie.

### **NIBP Module (A21)**

An OEM NIBP monitor supplied by CAS Medical Systems. This module performs blood pressure monitoring, determining systolic, diastolic and mean pressures and pulse rate. Measurement results pass serially by means of the A06 OEM PCB to the A01 System PCB ASIC for display. Readings may be taken one time or on a recurring interval.

### **Biphasic Module (A22)**

The biphasic module generates the biphasic waveform. The energy from the A15 Storage Capacitor is shaped into the biphasic waveform. The energy passes through the A14 Inductive Resistor and A13 Transfer Relay to the W11 Therapy Connector.

### **CO2 Module (A23)**

An OEM capnometry module supplied by Oridion Medical Ltd. This module continuously monitors end-tidal carbon dioxide (CO2) and respiratory rate. Measurement results pass serially by means of the A06 OEM PCB to the A01 System PCB ASIC for display.

### **ECG Connector Cable (W07)**

A front panel connector port used for attaching a 3-lead, 5-wire, or 12-lead ECG cable. Signal processing takes place on the A01 System PCB ECG front end processing circuitry (see [ECG front end \(p. 77\)](#)).

### **System Connector Cable (W08)**

A rear panel connector port used for the exchange of digital information with an external modem, personal computer, factory test systems, or Physio-Control field service test systems. The system connector also supplies a real-time analog ECG signal for use in basic central monitoring or telemetry systems.

### **Auxiliary Power Connector Cable (W09)**

A rear panel access port used for connection of external power adapters.

### Therapy Connector Cable (W11)

A patient connector port used for delivery of either defibrillation or pacing therapeutic energies. The therapy connector allows attachment of all available electrode accessories, including QUIK-COMBO pacing/defibrillation/ECG electrodes, and adult hard paddles with energy select and discharge control.

**NOTE:** Some therapeutic accessories such as pediatric or posterior paddle attachments connect to the device by means of the accessories mentioned previously.

The LIFEPAK 15 monitor/defibrillator uses varying jumper configurations within attached accessories to determine the type of accessory connected. Discriminator circuitry within the A04 Therapy PCB defibrillator processor subsystem decodes the accessory jumper configurations.

### Speed Dial Assembly (W15)

A rotary, optical pulse-code modulator used to navigate through and select specific items from the LIFEPAK 15 monitor/defibrillator menu system. Detent points on the SPEED DIAL provide tactile feedback to the user. When the desired item has been highlighted on the display, the user presses the SPEED DIAL to enter the selection. The SPEED DIAL forms part of the user controls and indicators block. Pulses derived from the W15 speed dial assembly pass serially to the user controls portion of A01 System PCB ASIC.

### Speaker Assembly (W17)

Used to annunciate device warnings, alarms, tones and, in AED mode, voice prompts. Drive for the W17 Speaker Assembly originates in the A01 System PCB combined audio output block. Final amplification occurs in the A05 Interface PCB audio amplifier.

### SpO2 Connector Cable (W22)

A front panel connector port on the parameter bezel used for attaching an SpO2 (oximeter) sensor.

### **CO2 Inlet Connector Cable (W28)**

A front panel connector port used for attaching a CO2 FilterLine®. Signal processing takes place on the CO2 module.

### **IP Connector Cable (W33)**

A front panel connector port used for attaching invasive pressure transducers.

### **Temperature Connector Cable (W35)**

A front panel connector port used for attaching external temperature probes.

## Modes of Operation

When the LIFEPAK 15 monitor/defibrillator is turned on, it is always in one of six modes of operation. See the following topics to learn more about a particular mode.

- [Manual Mode \(p. 90\)](#)—for performing manual defibrillation, synchronized cardioversion, noninvasive pacing, and ECG and vital sign monitoring.
- [AED Mode \(p. 91\)](#)—for automated ECG analysis and a prompted treatment protocol for patients in cardiac arrest.
- [Setup Mode \(p. 92\)](#)—for changing default settings of the operating functions. For additional information, see *LIFEPAK 15 Monitor/Defibrillator Setup Options* (MIN 3208011 for V1, or 3306226 for V2).
- [Service Mode \(p. 94\)](#)—for authorized personnel to perform diagnostic tests and calibrations.
- [Demo Mode \(p. 96\)](#)—for simulated waveforms and trend graphs for demonstration purposes.
- [Archive Mode \(p. 97\)](#)—for accessing stored patient information.

## Manual Mode

### Entering Manual Mode

To enter Manual mode, turn on the device. The factory default settings allow direct access to Manual mode. This access can be modified to require confirmation or a passcode, or can be restricted entirely.

- ◆ To change Manual mode access:
  1. Select MANUAL MODE in the Setup menu (see [Setup Mode \(p. 92\)](#)).
  2. In the Setup/Manual Mode submenu, select MANUAL ACCESS.

**Table 4.1— Mode Response Descriptions**

Mode/Response When Turned On	Response Description
Manual/Direct (default)	Turn on in Manual; direct access between AED and Manual modes
AED/Direct	Turn on in AED; direct access between AED and Manual modes
AED/Confirm Once	Turn on in AED; operator confirms Manual mode selection once
AED/Confirm Always	Turn on in AED; operator confirms Manual mode selection every time
AED/Passcode Once	Turn on in AED; operator enters Manual mode passcode once
AED/Passcode Always	Turn on in AED; operator enters Manual mode passcode every time
AED/Restricted	Turn on in AED; no access to Manual mode

## AED Mode

### About AED Mode and Entering AED Mode

Factory default settings allow the device to operate in Manual mode. If you want the device to operate in AED (automated external defibrillator) mode when it is turned on, you must change several setup options in different menus. The Setup/AED Mode menu allows you to change settings for the AED prompted protocol.

- ◆ To set up the device to turn on in AED mode:
  1. Select MANUAL MODE in the Setup menu (see [Setup Mode \(p. 92\)](#)).
  2. In the Setup/Manual Mode submenu, select MANUAL ACCESS.
  3. Select the desired AED/XXX option.
  4. Press HOME SCREEN.
  5. Select MONITORING and then select CHANNELS.
  6. Select SET 1 and then select CHANNEL 1.
  7. Select PADDLES.
  8. Select PREVIOUS PAGE. Confirm that Set 1 appears as the Default Set.

## Setup Mode

### About Setup Mode

Setup mode allows you to change the factory default settings and define custom settings based on local medical protocols and specific needs. Options include general characteristics, manual and AED mode operating characteristics, alarms setup, transmission sites, time-of-day clock, and other options. There is also a factory reset option that resets the device to the factory default settings, (except for transmission menu entries and the maintenance interval, which remain unchanged). When setup is complete, turn off the device to save the settings. The next time the device is turned on, the operating defaults you selected are active.

### Preserving the Existing Setup Options

Print the existing device setup options by selecting Print Defaults from the Setup mode menu or store setup options using the LIFEPAK Defibrillator Software Solutions Configuration Setup Tool before performing service.

**NOTE:** The LIFEPAK Defibrillator Software Solutions Configuration Setup Tool is a Windows<sup>®</sup>-based application designed to assist you in managing the setup options in your LIFEPAK 15 monitor/defibrillator. You can download the tool from [Physio-Control.com](http://Physio-Control.com).



### Entering Setup Mode

- ◆ To enter the Setup mode:
  1. Press and hold **OPTIONS** and **EVENT**, and then turn the device **ON**. Continue holding until the Setup mode passcode prompt appears. The factory default passcode is 0000; the reserved technician passcode is 5433.
  2. To enter the passcode, rotate the **SPEED DIAL** to select a digit, and then press the **SPEED DIAL** to continue. After the last digit is entered, the Setup menu appears.
  3. Rotate the **SPEED DIAL** to select a setup option, and then press the **SPEED DIAL** to display the option submenu.

For more detailed information about Setup mode options, see *LIFEPAK 15 Monitor/Defibrillator Setup Options* (MIN 3208011 for V1, or 3206226 for V2).

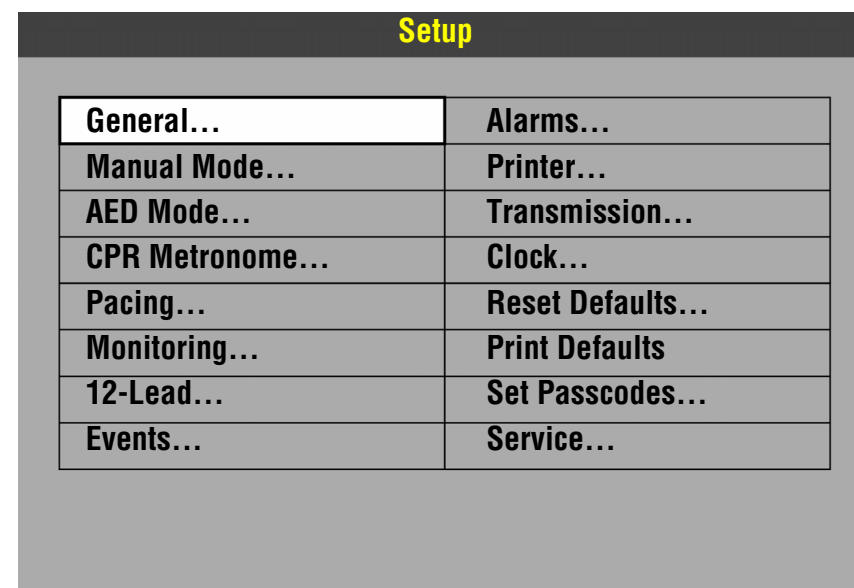
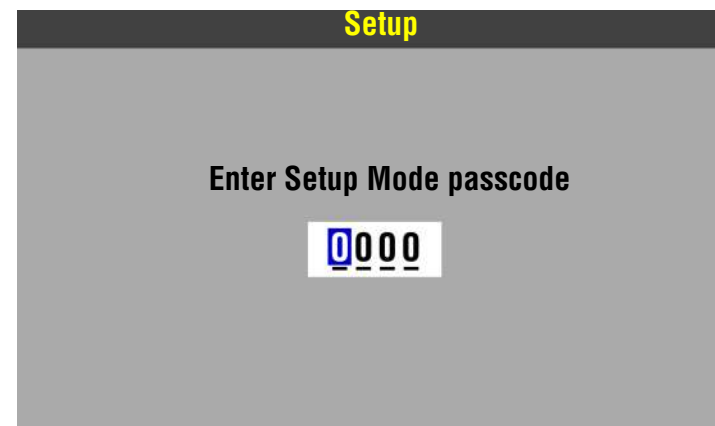

## Service Mode

### About Service Mode

Service mode functions allow qualified service personnel to:

- Perform device calibration routines:
  - ~ Defibrillation calibration
  - ~ Pacing calibration
  - ~ Printer calibration
  - ~ CO2 calibration
  - ~ NIBP calibration
  - ~ Temperature calibration
- Perform device tests:
  - ~ Buttons test
  - ~ Pixels test
  - ~ Printer test
  - ~ Voice/Tone test
- View the device status registers:
  - ~ Device Log status
  - ~ Service Log status
  - ~ Device Data status
  - ~ Counters status
  - ~ Clear Memory (clears data management memory)
- Set the Service mode passcode
- Set the maintenance prompt interval

### Entering Service Mode

- ◆ To enter the Service mode:
  1. Enter the Setup Mode (see [Setup Mode \(p. 92\)](#))
  2. Rotate the SPEED DIAL to select SERVICE in the Setup menu, and then press the SPEED DIAL. The Service mode passcode prompt appears. The factory default passcode is 0000; the reserved technician passcode is 5433.
  3. To enter the passcode, rotate the SPEED DIAL to select a digit, and then press the SPEED DIAL to continue. After the last digit is entered, the Service menu appears.
  4. Rotate the SPEED DIAL to select a service option, and then press the SPEED DIAL to display the option overlay.

**Calibration** — See [Test and Calibration Procedures \(TCP\) \(p. 188\)](#).

**Tests** — See [Performance Inspection Procedures \(p. 98\)](#).

**Status** — See [Troubleshooting \(p. 218\)](#).

**Set Passcode** — Set a Service mode access passcode.

**Maint Prompt** — See [Preventive Maintenance \(p. 265\)](#).

**Setup** — Return to the Setup Home Screen.

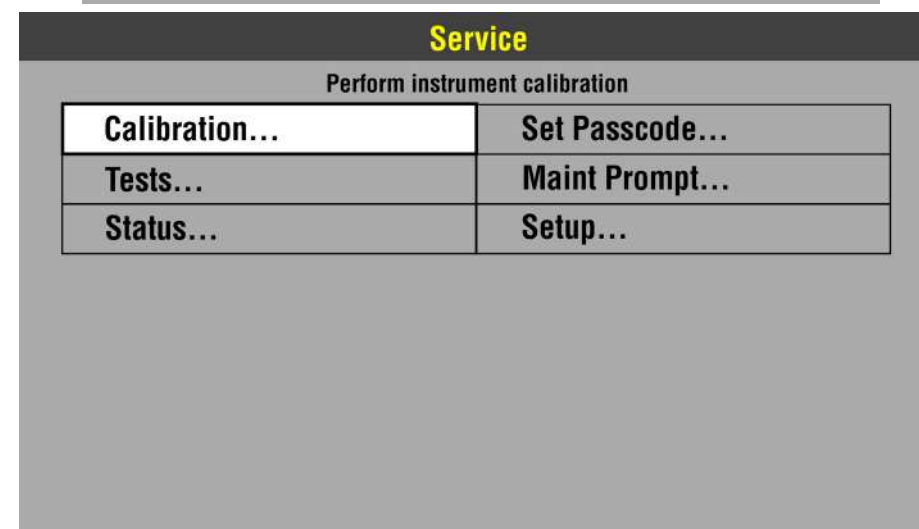

## Demo Mode

### About Demo Mode

Demo mode allows you to practice or demonstrate the monitoring functions of the LIFEPAK 15 monitor/defibrillator, including:

- ECG lead selection
- SpO<sub>2</sub>
- SpCO
- SpMet
- CO<sub>2</sub>
- NIBP
- IP
- Temperature
- Trend graphs
- Alarms
- Events

### Entering Demo Mode

- ◆ To enter Demo mode:
  1. Remove all front panel cables from the device (therapy, ECG, etc.). You cannot enter Demo mode if any front panel cable is attached.
  2. Press and hold EVENT and HOME SCREEN, and then turn on the device. The Demo mode screen appears.
  3. To exit Demo mode, turn the device off.

## Archive Mode

### About Archive Mode and Entering Archive Mode

Patient information is stored in Archive mode. When you enter Archive mode, patient monitoring ends and the current Patient Record is saved and closed.

◆ To enter Archive mode:

1. Turn on the device and press OPTIONS.
2. Select ARCHIVES, and then select YES.

**NOTE:** You may be required to enter a password to enter Archive mode.

3. Turn the device OFF to exit Archive mode.

## Performance Inspection Procedures

The Performance Inspection Procedures (PIP) are a set of manual test procedures used for an operational, closed-case evaluation of the LIFEPAK 15 monitor/defibrillator. This section describes the test procedures you will perform to determine if the LIFEPAK 15 monitor/defibrillator is operating within the required specifications. Investigate and correct any malfunctions or out-of-tolerance conditions detected during the PIP.

The PIP comprises safety and performance tests recommended by AHA/ASHE (American Hospital Association/American Society for Hospital Engineering) *Maintenance Management for Medical Equipment* and International Electrotechnical Commission (IEC) Technical Report 1288-2, *Maintenance of Cardiac Defibrillators-Monitors*.

Perform the PIP as part of a regularly scheduled preventive maintenance routine. Also, perform the PIP after any repair, replacement, upgrade, or any test and calibration procedure (see [Test and Calibration Procedures \(TCP\) \(p. 188\)](#)). The [Performance Procedure Checklist \(p. 647\)](#) is provided as an optional tool for recording test results. For additional items, see the *Operator's Checklist* found at the end of *LIFEPAK 15 monitor/defibrillator Operating Instruction* (MIN 3207184 for V1, or 3306222 for V2).

- [PIP – Scope and Applicability \(p. 100\)](#)
- [PIP – Resource Requirements \(p. 101\)](#)
- [PIP – Test Equipment Requirements \(p. 102\)](#)
- [Manual Mode Access \(p. 106\)](#)
- [PIP – Device Preparation \(p. 110\)](#)
- [Power Management \(p. 114\)](#)
- [PIP – User Test and Date/Time Verification \(p. 118\)](#)
- [Miscellaneous Functions \(p. 119\)](#)
  - ~ [PIP - Temperature Calibration Check Test \(p. 119\)](#)
  - ~ [PIP – CO2 Tests \(p. 123\)](#)
  - ~ [PIP – NIBP Tests \(p. 129\)](#)
- [PIP – Printer Tests \(p. 133\)](#)
- [PIP – Keypad Tests \(p. 136\)](#)

- [PIP – Audio Test \(p. 137\)](#)
- [PIP – Invasive Pressure Verification - P1, P2 \(p. 138\)](#)
- [PIP – SpO2/SpCO/SpMet Test \(p. 140\)](#)
- [PIP – Recording Operating Data \(Optional\) \(p. 141\)](#)
- [PIP – ECG Performance Testing \(p. 142\)](#)
- [PIP – Defibrillator/Pacing Testing \(p. 151\)](#)
- [PIP – QUIK-COMBO ECG Characteristic Tests \(p. 156\)](#)
- [PIP – Standard Paddles User Test \(p. 159\)](#)
- [PIP – Standard Paddles Defibrillator Delivered Energy Tests \(p. 161\)](#)
- [PIP – Patient Impedance Test \(p. 171\)](#)
- [Data Management \(p. 172\)](#)
- [PIP – Leakage Current Tests \(p. 177\)](#)
- [PIP – Disabling/Resetting Maintenance Prompt \(p. 187\)](#)

### PIP – Scope and Applicability

The PIP applies to the LIFEPAK 15 monitor/defibrillator only. To complete the PIP, begin with the device preparation instructions (see [PIP – Device Preparation \(p. 110\)](#)). All required PIP tests applicable to the device configuration under test must be performed.

See [PIP – Resource Requirements \(p. 101\)](#) for a listing of the necessary qualifications for PIP equipment, test equipment verification, workstation power, and personnel.

See [PIP – Test Equipment Requirements \(p. 102\)](#) for a listing of test equipment, including specifications, required to complete the PIP.



### PIP – Resource Requirements

This section describes the requirements for PIP test equipment and PIP personnel.

#### PIP Test Equipment

To perform the PIP, use only the equipment listed in the Test Equipment Requirements table ([Table 5.1 on page 102](#)). Although the table lists specific test equipment by manufacturer, test equipment with equivalent specifications may be substituted.

**NOTE:** Using test equipment other than that specified in the Test Equipment Requirements table may provide test results that are different from those specified in this manual. It is the responsibility of the bio-medical personnel who maintain this device to determine test equipment equivalency.

**NOTE:** SpO2 monitor/probe accuracy can not be accessed using functional test equipment. Unlike many other types of medical electrical equipment, SpO2 (pulse oximeter) equipment is not designed to be calibrated after it leaves the factory. Currently there are no accepted method of verifying the correct calibration of a SpO2 (pulse oximeter) monitor/probe combination other than testing on human beings. Source: EN ISO 9919:2009 - 6.8.3 aa) 1) 2) and Annex FF.

Use only Physio-Control device accessories, including cables, batteries, and the appropriate Physio-Control battery charger.

All test equipment used to perform the PIP must have a current calibration label, issued by a certified calibration facility.

#### PIP Personnel

Technicians who perform the PIP must be properly qualified and thoroughly familiar with the operation of the device, meeting the requirements described in [Service Personnel Qualifications \(p. 15\)](#) in the Preface.

#### PIP Workstation Power

The AC line power to the workstation used must be connected to a grounded power source.

### PIP – Test Equipment Requirements

The following test equipment, or equivalent, is required to conduct the PIP.

**Table 5.1—Test Equipment**

Equipment	Specifications or Description	Manufacturer or Part Number
Defibrillator analyzer with external noninvasive pacer measurements <sup>a</sup>	Energy range: 0 to 450 J Load resistance: $50 \Omega \pm 1\%$ Accuracy: +/- 2%, non-inductive Waveforms: Simultaneous 12-lead output Rates: 30 bpm, 120 bpm, with rate accuracy of $\pm 1\%$ Amplitude: $1 \text{ mV} \pm 5\%$ , based on Lead II ECG performance: Amplitudes of Lead II and Leads V1-V6 are equivalent. Lead I = 70% amplitude of Lead II. Sine wave: 10 Hz @ $1 \text{ mV} \pm 2\%$ , based on Lead II	Fluke® Biomedical Impulse 7000DP with QUIK-COMBO adapter accessory 16/7 D/P ADPT104*
Patient simulator	Simultaneous 12-lead output Rates: 30 bpm, 120 bpm, with rate accuracy of $\pm 1\%$ Amplitude: $1 \text{ mV} \pm 5\%$ , based on Lead II ECG performance: Amplitudes of Lead II and Leads V1-V6 are equivalent. Lead I = 50% amplitude of Lead II. Sine wave: 10 Hz @ $1 \text{ mV} \pm 2\%$ , based on Lead II Blood pressure accuracy: $\pm 1\%$ full scale, $\pm 1 \text{ mmHg}$	Fluke Biomedical DNI 215A/217A or BC Biomedical PS-22 Series*
Safety analyzer	90 V ac rms to 264 V ac rms mains voltage Current range: 0-1999 $\mu\text{A}$ Current accuracy: 5% of reading or 1 digit (whichever is greater) Insulation resistance test: 0.5 M ohm to 20 M ohm and 20 M ohm to 100Mohm Accuracy +/- 2% of reading + 0.2 Mohm +/- 7.5% of reading + 0.2 Mohm	Fluke Biomedical ESA612*

**Table 5.1—Test Equipment (Continued)**

Equipment	Specifications or Description	Manufacturer or Part Number
ESA612 adapter box	Provides addition ECG snap connections	Fluke Biomedical model 1210
Decade resistance box	0 to 9 M $\Omega$ resistance box Resolution: 1 $\Omega$ ; accuracy: $\pm$ 1%	IET RS-200 Resistance Substituter*
Digital pressure meter	1% accuracy for pressure and vacuum	Fluke Biomedical DPM2Plus*
QUIK-COMBO therapy cable		Physio-Control P/N 3207047
FAST-PATCH cable assembly	Connects QUIK-COMBO to test posts	Physio-Control P/N 3011030 or Fluke Biomedical QUIK-COMBO adapter accessory 16/7 D/P ADPT104
Electrode test posts (2 ea)		Physio-Control tool P/N 3205979
Stop watch	Elapsed timer (minutes, seconds) Time accuracy: $\pm$ 0.5 Sec	ACCUSPLIT AX725*
3-lead ECG cable	Standard accessory with the 3-lead LIFEPAK 15 monitor/defibrillator	Physio-Control P/N 3006218
5-wire ECG cable	Optional 5-wire cable for LIFEPAK 15 monitor/defibrillator	Physio-Control P/N 3200496
12-lead ECG cable	Standard accessory with the 12-lead LIFEPAK 15 monitor/defibrillator	Physio-Control P/N 805265
General purpose oscilloscope	(Optional) Bandwidth: DC to 2 MHz Vertical accuracy: $\pm$ 3% (5 mv – 5 v/div.) Horizontal time base accuracy: $\pm$ 5%	Fluke 190*
SpO2/SpCO/SpMet sensor	Masimo Rainbow adult reusable sensor	Physio-Control P/N 3201655/DCI-dc3, DCI-dc8 or DCI-dc12

**Table 5.1—Test Equipment (Continued)**

Equipment	Specifications or Description	Manufacturer or Part Number
Lithium-ion battery pak	Li-ion battery with fuel gauge, battery age is less than 2 years old.	Physio-Control P/N 3206735
NIBP calibration kit with syringe		Physio-Control tool P/N 3012432-01
NIBP hose	9 feet long	Physio-Control tool P/N 3207353-004
Invasive pressure cable		3010-0116 (use with 217A) or BC20-41301 (use with PS-22 Series)*
Tubing assembly - CO2 leak test		Physio-Control tool P/N 3012430-00
Tubing assembly - CO2 calibration		Physio-Control tool P/N 3012430-01
Calibration gas	5% CO2, balance N2	Physio-Control P/N 3012556
FilterLine H set, adult/pediatric		Physio-Control P/N 3012176/XS-04660
Analog ECG output cable	Connects to the System Connector	Physio-Control P/N 3010484
QUIK-COMBO to ECG snap terminator cable	(Alternative setup) - Alligator clip wires from FAST-PATCH cable to test equipment ECG snap.)	Physio-Control tool P/N 3009139
ECG Snap to Banana Plug cable	For use in testing electrical safety	Physio-Control tool P/N 3305684
SpO2 Connector to ECG snap cable	For use in testing SpO2 electrical safety.	Physio-Control tool P/N 3305685
Hard paddle	Optional therapy delivery accessory	Physio-Control P/N 3207051
Hard paddle leakage adapter	Optional - for use in testing Hard Paddle electrical safety	Physio-Control tool P/N 3206631
Hard paddle QC leakage cable	Optional - for use in testing Hard Paddle electrical safety	Physio-Control tool P/N 3207066
Laptop computer	<i>Bluetooth</i> wireless technology option installed	Dell 630*

**Table 5.1—Test Equipment (Continued)**

Equipment	Specifications or Description	Manufacturer or Part Number
CODE-STAT Reviewer software		Physio-Control P/N 3011520 Version 8.0 (minimum version required)
Battery leakage test adapter	Quantity 2, connection to exposed metal in battery well	Physio-Control tool P/N 3305682
Temperature probe simulator	Accuracy $\pm$ 0.05 degrees C for all settings	Fogg TP 400
Cable assembly, temperature adapter		Physio-Control P/N3303938-000
Fogg TP400 Interface cable		Physio-Control P/N 3308413
AC to DC Power Adapter		Physio-Control P/N 3303483
External Power Extension Cable		Physio-Control P/N 3303642-001

a. Some energy meters are not accurate for biphasic waveforms; contact your defibrillator analyzer's manufacturer for more information.

\*Equivalent equipment is required to meet the specifications listed in the specification column.

### Manual Mode Access

It is recommended that the device be set up for Manual mode when performing the PIP.

**NOTE:** If you do not wish to change the setup for a device configured with manual access restrictions, it may be necessary to use the reserved technician passcode of **5433** to gain access to Manual mode.

**NOTE:** Be sure to make note of the customer settings to restore the device to the user-selected MANUAL ACCESS configuration at the completion of this PIP.

- ◆ To set up the device for Manual mode access:  
*(4 steps, Page 1 of 3)*
  1. Access the Setup mode as follows:
    - a. Press and hold OPTIONS and EVENT, and then turn the device ON.
    - b. When the Setup mode passcode prompt appears, enter 5433.

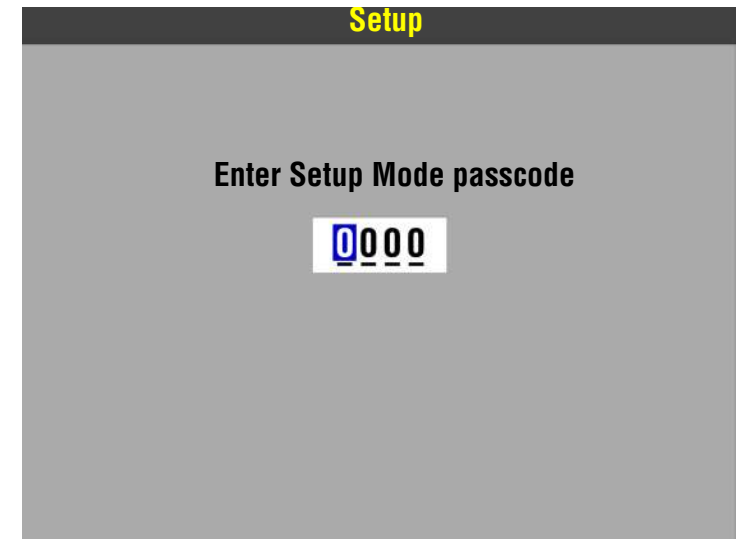

Figure 5.1—Manual mode passcode

- ◆ To set up the device for Manual mode access: (Continued)  
*(4 steps, Page 2 of 3)*
  2. Select MANUAL MODE in the Setup menu.

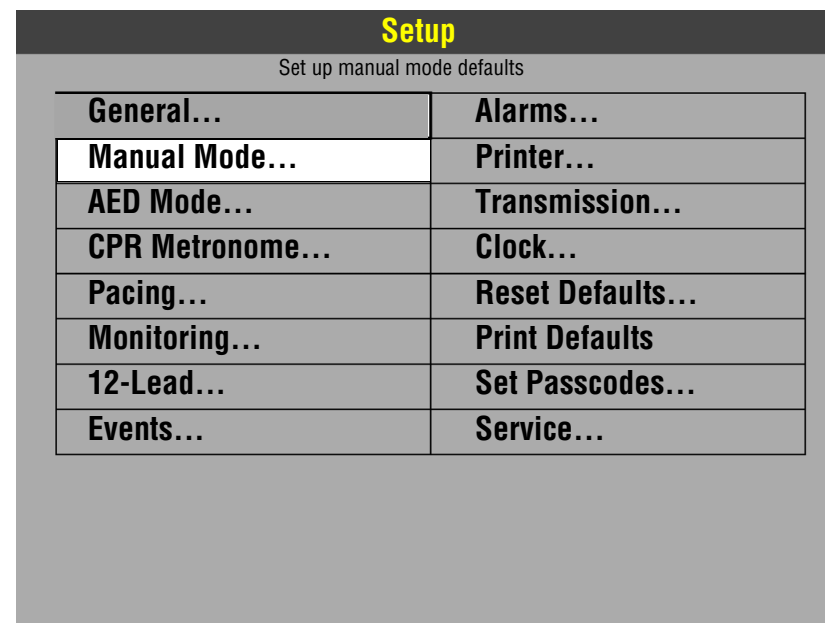

Figure 5.2—Manual mode menu selection



- ◆ To set up the device for Manual mode access: (Continued)  
*(4 steps, Page 3 of 3)*
- 3. In the Setup/Manual Mode submenu, set the MANUAL ACCESS selection to MANUAL/DIRECT.

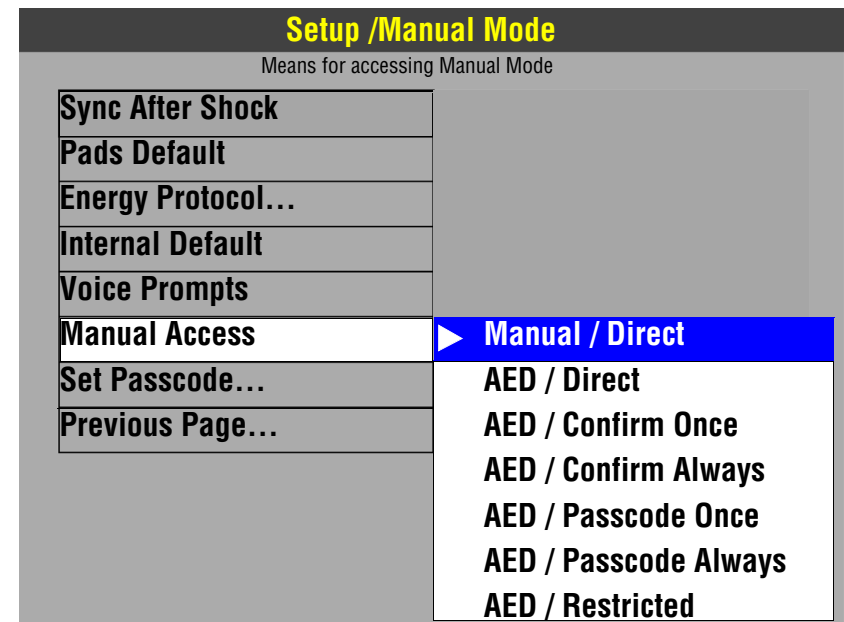

Figure 5.3—Manual mode submenu

- 4. Turn the device OFF by pressing ON for two seconds, and then continue with the next test.

### PIP – Device Preparation

This section describes the inspection and setup procedures to prepare the device for the PIP.

- All required PIP tests applicable to the device configuration under test must be performed.
- The [Performance Procedure Checklist](#) is provided as an optional tool for the recording of test results.
- To correct failures, see [Troubleshooting \(p. 218\)](#), and then repeat the PIP.



Figure 5.4—LIFEPAK 15 exterior view

### Exterior Physical Inspection

- ◆ To perform an exterior physical inspection: (10 steps, Page 1 of 2)
  1. Inspect the device exterior for the following:
    - ~ Damage
    - ~ Excessive wear
    - ~ Improper mechanical function
    - ~ Damaged connectors
  2. Pick up and turn over the device and listen for loose or rattling hardware. Locate any loose or rattling hardware, and then tighten or replace it.
  3. Inspect the rubber feet on the underside of the lower enclosure. Reinstall or replace rubber feet as necessary.
  4. Inspect the battery connector pins.
    - ~ Tighten loose pins (see [Battery Pin Replacement \(p. 484\)](#)).
    - ~ Examine each leaf on the connector pins to make sure it is not cracked or broken.
  5. Inspect the pins and connector housings of all QUIK-COMBO, hard paddles, and other therapy cables for damage.
  6. Verify the spring button on the therapy connector is functional prior to engaging a therapy cable into the therapy connector.
  7. Inspect the ECG, SpO2\*, CO2\*, NIBP\*, IP\*, Temp\* and system connectors for damage, cracks, or contamination (\*if equipped).

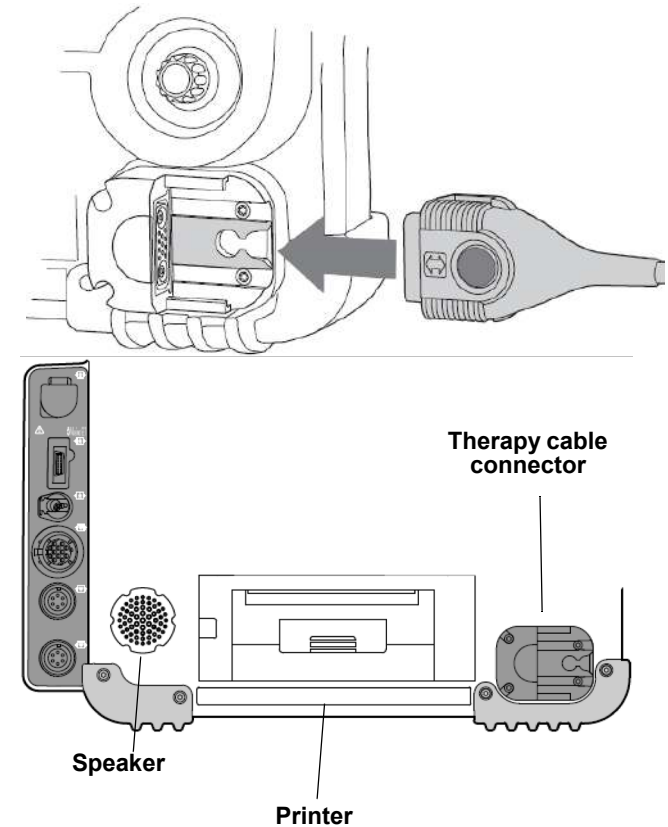

Figure 5.5—Physical inspection

- ◆ To perform an exterior physical inspection: *(Continued)* (10 steps, Page 2 of 2)
  8. Inspect the keypads and overlays for damage, cracks, separations.
  9. Check all other accessory cables, ECG, SpO2 sensors, CO2 tubing, NIBP tubing, Temperature sensors and related items for expiration dates, general condition, and suitability for use.
  10. Inspect carrying strap and mounts (if the device is equipped with them).

### Device Setup

#### WARNING

**SHOCK HAZARD** The device discharges up to 360 joules of electrical energy through the defibrillator cable. You must safely discharge this electrical energy as described in this PIP. Do not attempt to perform this procedure unless you are thoroughly familiar with the operation of the device.

- ◆ To set up the device in preparation for the PIP:
  1. Verify two, fully functional, charged, Lithium-ion batteries are showing more than two charge bars.  
**NOTE:** A functional charged battery is one that does not return a LOW BATTERY message after turning on the device.
  2. Insert the two Li-ion batteries into the device.
  3. Verify that each battery clicks into position in the battery wells.
  4. Install a roll of printer paper into the printer.
  5. Connect the QUIK-COMBO therapy cable (or optional hard paddles) to the therapy connector.  
**NOTE:** If the device is outfitted with hard paddles, perform the PIP tests specific to hard paddles instead of the tests specific to QUIK-COMBO.

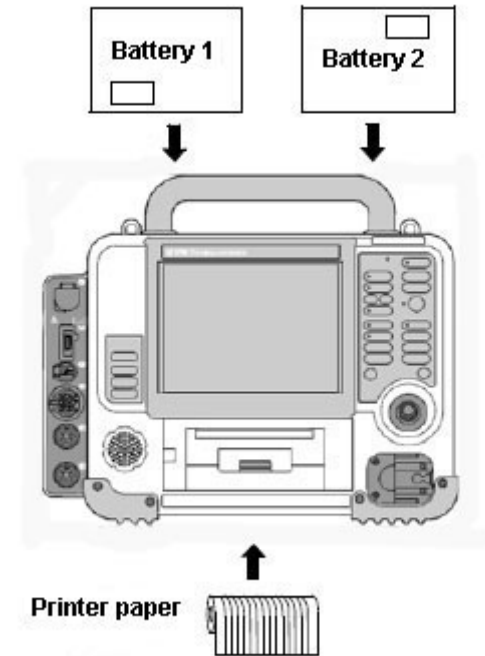

Figure 5.6—Device setup

## Power Management

Perform the following power management tests:

- [PIP – Power On/Self Test \(p. 114\)](#)
- [PIP - Auxiliary Power Switching \(p. 116\)](#)
- [PIP – Power Source Management Test \(p. 117\)](#)

### PIP – Power On/Self Test

◆ To perform the Power On/Self-Test: (8 steps, Page 1 of 2)

1. Turn the device ON.
2. Verify the entire self-test completes in 10 seconds or less.

**NOTE:** The startup screen appears while the device is starting up and performing its self tests. The copyright is formatted as “Physio-Control Inc. (*year*).” The year shown will vary with software versions. The system software part number is also displayed at the bottom of screen.

3. Verify that the power ON LED remains illuminated after the self-test.
4. Verify that all front panel LEDs flash (except the ON LED, which glows steadily) for approximately 0.5 seconds during the self-test.
5. Verify that the speaker emits a clear, single-beep test tone.



Figure 5.7—Startup screen

- ◆ To perform the Power On/Self-Test: *(Continued)* (8 steps, Page 2 of 2)
  6. Verify that the Service LED is OFF.
  7. Verify that the display screen appears similar to Figure 5.8.
  8. Turn the device OFF, and continue with the next test.



Figure 5.8—Display screen

### PIP - Auxiliary Power Switching

◆ To test auxiliary power switching:

**NOTE:** Perform the auxiliary power switching test if the device is equipped with the Auxiliary power connector on rear case. Otherwise, skip to [PIP – Power Source Management Test \(p. 117\)](#).

1. Connect the power adapter to the power source and the output cable to the Auxiliary Connector at the rear of the device. See the *Operating Instructions - AC and DC Power Adapters* for more information.
2. Turn on the device and verify that the battery icons appear but neither is highlighted.
3. Unplug the Power Adapter cable from the device's auxiliary connector. One of the device battery icons is highlighted.
4. Record the results on the [Performance Procedure Checklist \(p. 647\)](#).

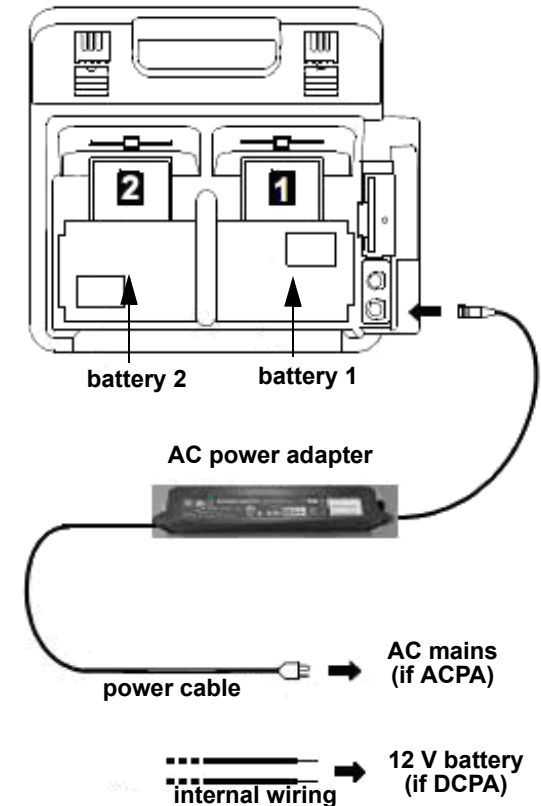

Figure 5.9—AC power adapter testing setup



### PIP – Power Source Management Test

- ◆ To test battery power source management:
  1. Turn the device ON.
  2. Verify the device displays the battery status indicators showing the following information:
    - ~ The presence of batteries in Battery Wells 1 and 2.
    - ~ Which battery is being used (the battery in use is indicated by a white battery number in a black box).
    - ~ The state of charge on each battery.
    - ~ When two batteries are installed prior to turn ON, the device will use the battery with the lowest charge first.
  3. Remove Battery 1. Verify the device indicates no battery is in Well 1 and the device is being powered by Battery 2.
  4. Reinsert Battery 1 and remove Battery 2. Verify the device indicates no battery is in Well 2 and the device is being powered by Battery 1.
  5. Reinsert Battery 2.
  6. Turn the device OFF, and continue with the next test

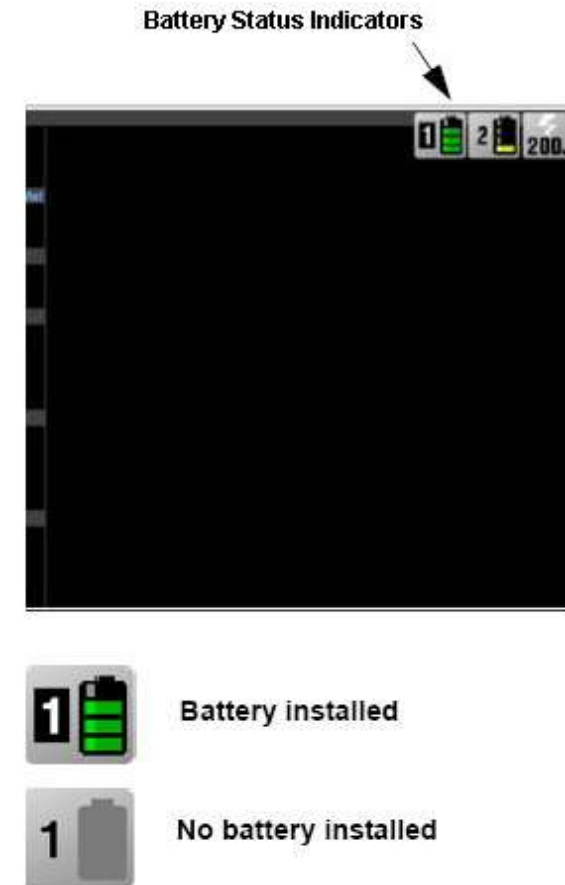

Figure 5.10—Battery status indicators

### PIP – User Test and Date/Time Verification

- ◆ To perform the User Test:
  1. Turn the device ON.
  2. Press OPTIONS to access the Options menu.
  3. Select USER TEST. The device automatically performs the following tasks:
    - Performs self-tests.
    - Charges to 10 joules and discharges internally (this energy is not accessible at the therapy connector).
    - Prints a Pass/Fail report.
  4. Verify on the printout that the device passes the user test and that the correct date and time values are also displayed on the printout.

**Note:** If the date and time are incorrect, reset using the Options/Date/Time menu.
  5. Turn the device OFF, and continue with the next test.

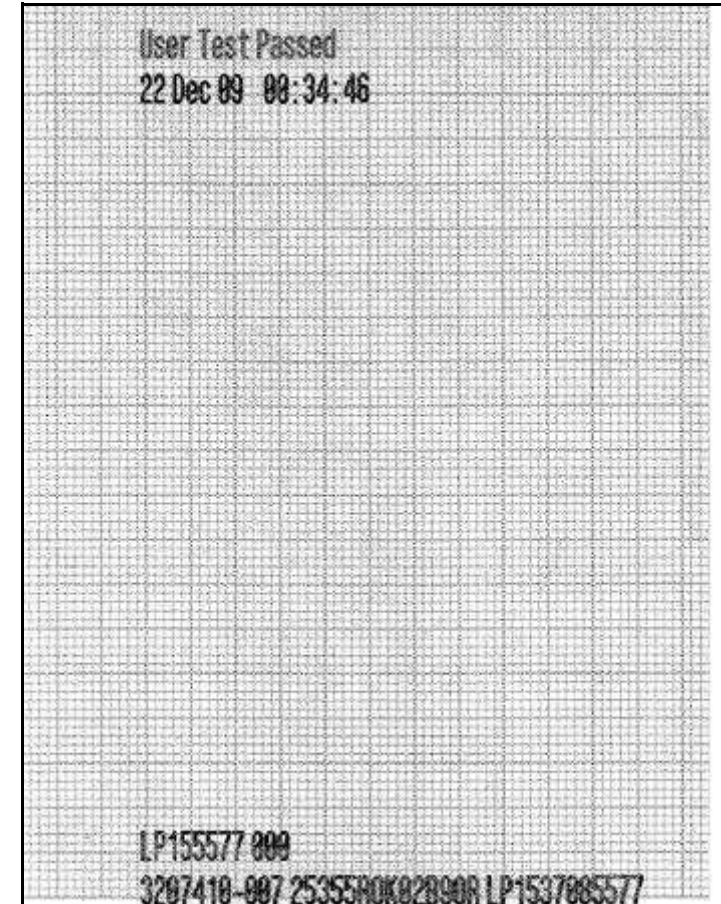

Figure 5.11—Date and time printout

### Miscellaneous Functions

Miscellaneous function tests include:

- [PIP - Temperature Calibration Check Test \(p. 119\)](#)
- [PIP – CO2 Tests \(p. 123\)](#)
- [PIP – NIBP Tests \(p. 129\)](#)

#### PIP - Temperature Calibration Check Test

**NOTE:** Perform the Temperature test if the device is equipped with the Temperature option. Otherwise, skip to [PIP – CO2 Tests \(p. 123\)](#).

##### Test setup

This procedure requires the following equipment and test cables:

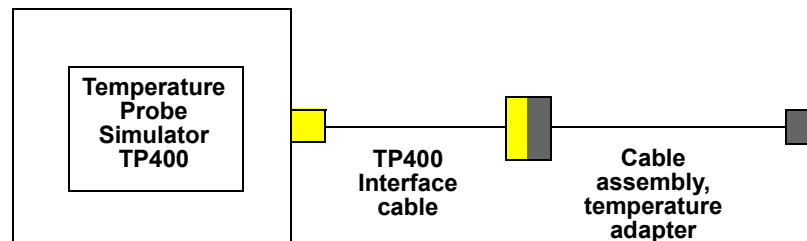

Figure 5.12—Temperature calibration check test setup

### PIP - Temperature Calibration Check Test

- ◆ To test temperature calibration check: (8 steps, Page 1 of 3)
  1. Turn the device ON.
  2. Access the Service mode (see [Entering Service Mode \(p. 95\)](#)).
  3. Select Calibration from the Service menu. The screen shown in Figure 5.13 appears.

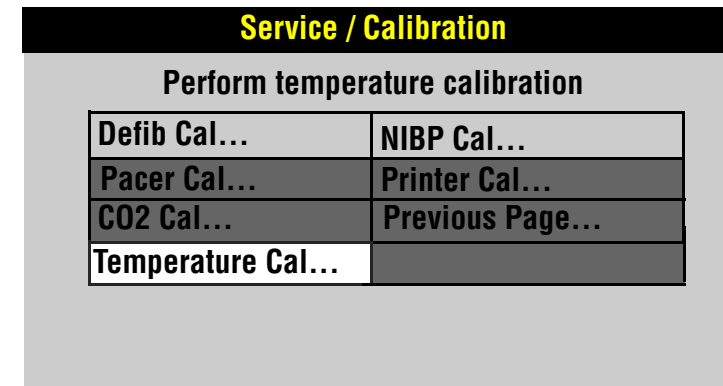

Figure 5.13—Calibration selection

◆ To test temperature calibration check: *(Continued)* (8 steps, Page 2 of 3)

4. Select the Temperature Cal from the Service /Calibration menu. The screen shown in Figure 5.14 appears.

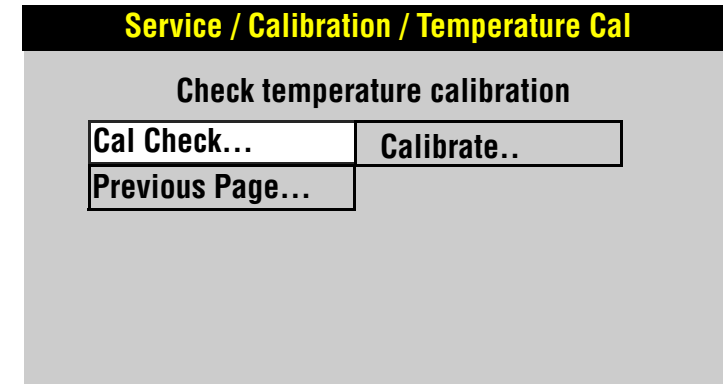

Figure 5.14—Temperature calibration selection

5. To initiate Temperature Calibration Check, select Cal Check from the Service / Calibration / Temperature Cal menu. The screen shown in Figure 5.15 appears.

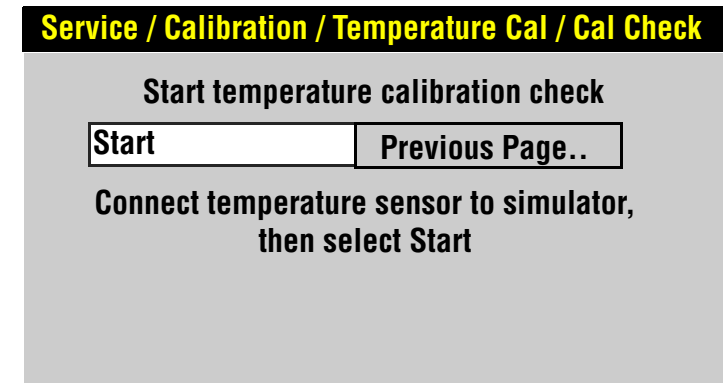

Figure 5.15—Starting calibration check

- ◆ To test temperature calibration check: *(Continued)* (8 steps, Page 3 of 3)
  6. Connect the temperature sensor to the device and select the Start button. The screen shown in Figure 5.15 appears.
  7. Set the temperature simulator to 37.0 C and then select the Next button. The screen shown in Figure 5.16 appears

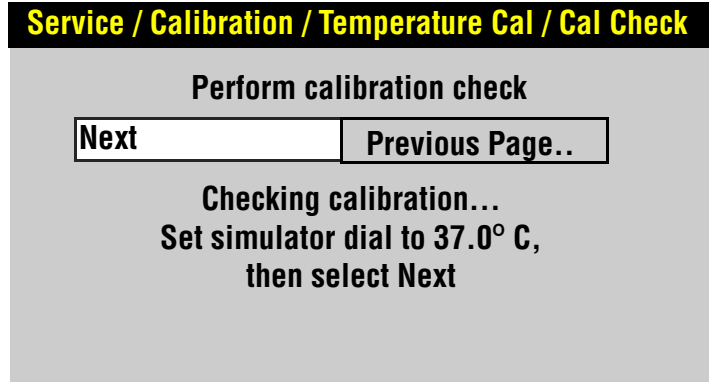

Figure 5.16—Calibration checking

8. When the calibration check is complete, the screen shown in Figure 5.17 appears.  
**NOTE:** Perform [TCP – Temperature Calibration Test \(p. 195\)](#) when the Temperature Calibration Check test fails.

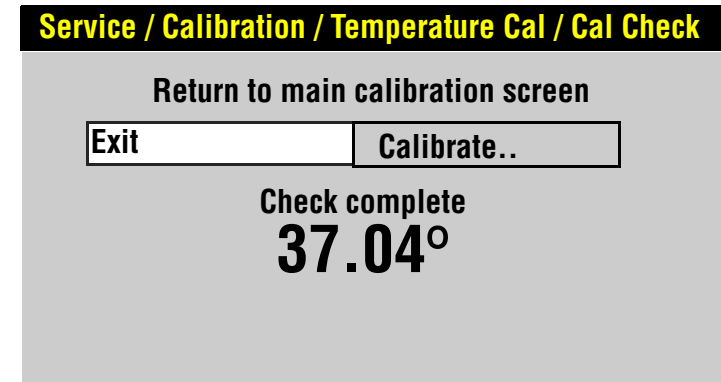

Figure 5.17—Cal check completion

### PIP – CO2 Tests

**NOTE:** Perform the CO2 tests if the device is equipped with the CO2 option. Otherwise, skip to [PIP – NIBP Tests \(p. 129\)](#).

CO2 tests consist of:

- ~ [CO2 Leakage Test \(p. 124\)](#)
- ~ [CO2 Calibration Check \(p. 125\)](#)

### CO2 Leakage Test

- ◆ To test the CO2 monitoring system for leaks:
  1. Set up the test equipment as shown in Figure 5.18.

**NOTE:** Make sure the device is turned OFF and no tubing is connected to the device.
  2. Open the hose clamp and depress the syringe fully.
  3. Connect the tubing to the front panel CO2 connector and to the back panel CO2 gas outlet. (**Important:** Press the fittings that connect to the device firmly to avoid leakage. All tubing ends should now be connected as shown in Figure 5.18.)
  4. Pull the syringe plunger out to induce a vacuum into the system. When the vacuum manometer indicates approximately -230 mmHg (-300 mBars), close the tubing clamp firmly.
  5. Begin timing as the clamp is closed. Verify that after 30 seconds, the change in vacuum reading is less than 15 mmHg (20 mBars).
  6. Open the tubing connection to the front panel CO2 connector to release the vacuum.
  7. Continue with the next test.

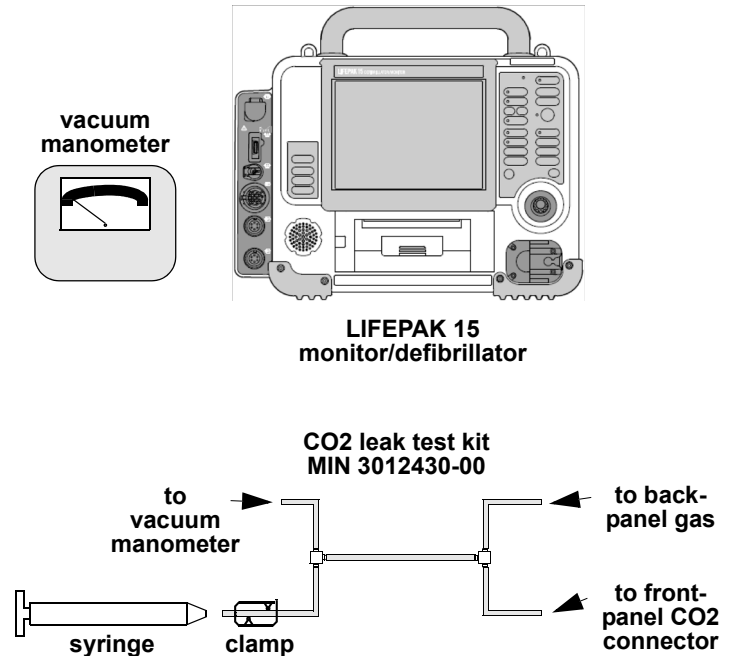

Figure 5.18—CO2 monitoring test set up



### CO2 Calibration Check

- ◆ To check CO2 calibration:  
*(10 steps, Page 1 of 4)*
  1. Turn the device ON.
  2. Access the Service mode (see [Entering Service Mode \(p. 95\)](#)).
  3. Select CALIBRATION from the Service menu.
  4. Select CO2 CAL.

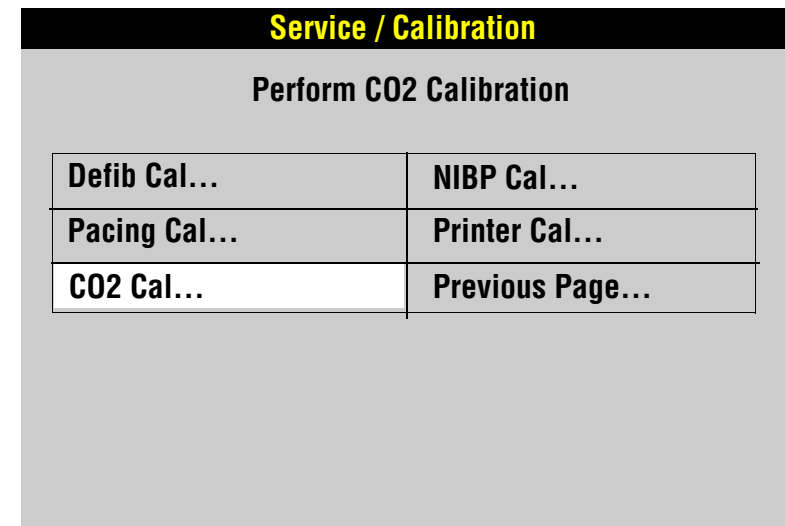

Figure 5.19—CO2 service calibration menus

- ◆ To check CO2 calibration: *(Continued)*  
*(10 steps, Page 2 of 4)*
  5. Select CAL CHECK.

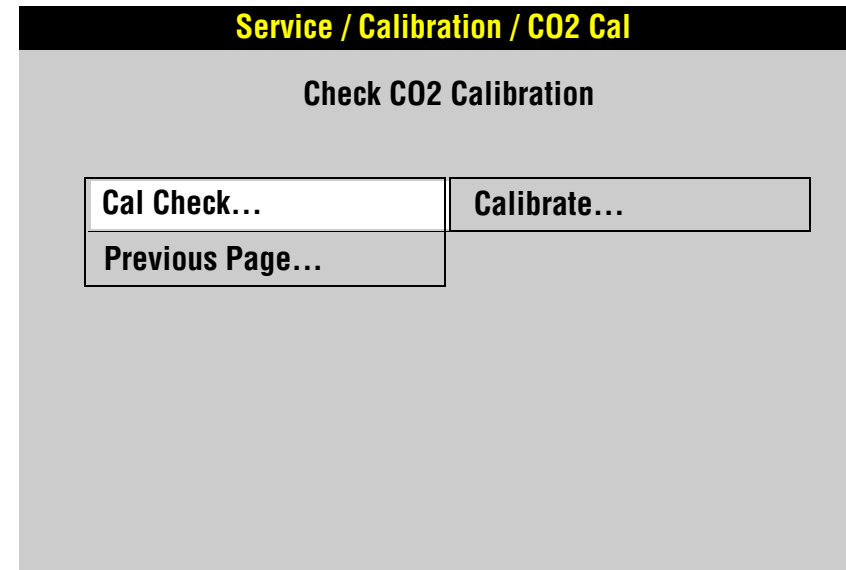

Figure 5.20—Service calibration Cal Check

- ◆ To check CO2 calibration: *(Continued)*  
*(10 steps, Page 3 of 4)*

6. Connect the calibration gas canister to the front panel CO2 connector using a standard CO2 FilterLine and the CO2 calibration kit.

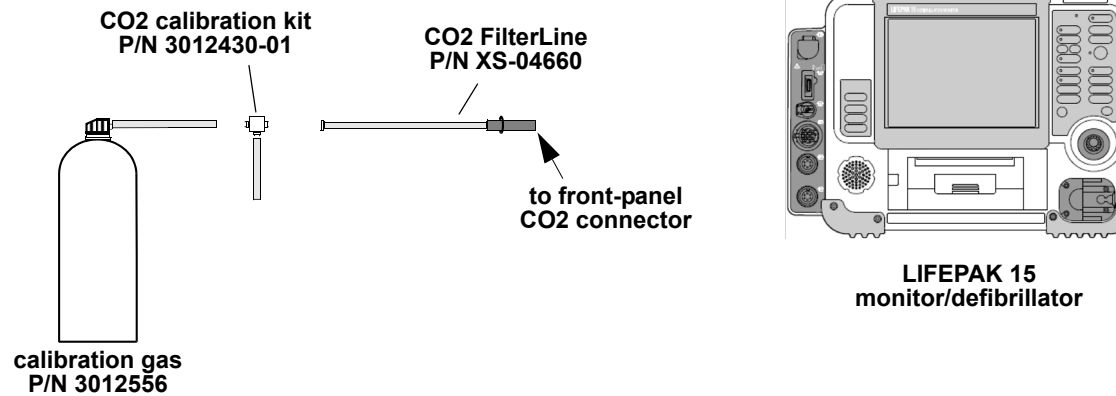
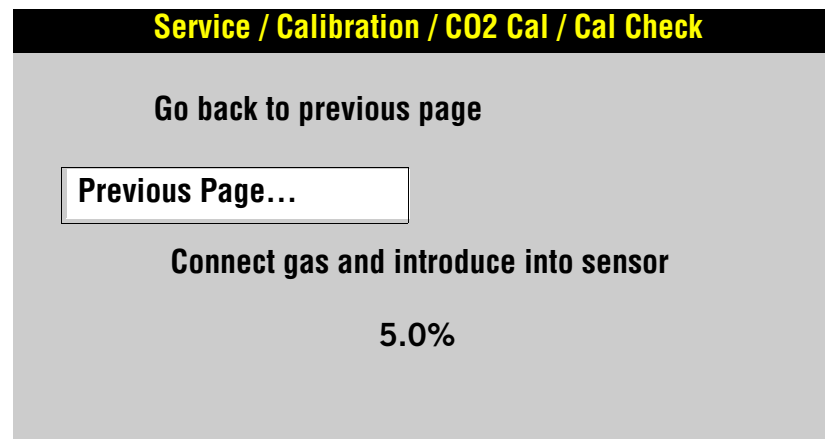

Figure 5.21—CO2 calibration connection

- ◆ To check CO2 calibration: *(Continued)*  
*(10 steps, Page 4 of 4)*

7. Press and hold the spray nozzle to apply the calibration gas. Release the spray nozzle when the device displays a stable value for the measured CO2 content of the calibration gas.
8. Verify that the measured gas concentration reads  $5.0\% \pm 0.5\%$ .

**NOTE:** If the measured value is incorrect, perform [TCP – CO2 Calibration \(p. 207\)](#).



**Figure 5.22—Service/Calibration submenu**

9. Select PREVIOUS PAGE twice to return to the Service/Calibration submenu.
10. Continue with the next test.

### PIP – NIBP Tests

**NOTE:** Perform the NIBP tests if the device is equipped with the NIBP option. Otherwise, skip to [PIP – Invasive Pressure Verification - P1, P2 \(p. 138\)](#).

NIBP tests consist of:

- ~ [NIBP Leakage Test \(p. 130\)](#)
- ~ [NIBP Calibration Check \(p. 131\)](#)

### NIBP Leakage Test

- ◆ To check the NIBP monitoring system for leaks:
  1. Access the Service mode (see [Entering Service Mode \(p. 95\)](#)).
  2. Select NIBP CAL in the Service/Calibration submenu.
  3. Select LEAKAGE from the Service/Calibration/NIBP Cal submenu.
  4. Connect a length of NIBP tubing to the NIBP connector.
  5. Occlude the distal end of the NIBP tube by plugging it or folding it double and pinching it.
  6. Select START. The device pressurizes the tubing to approximately 200 mmHg. Verify that the message LEAKAGE TEST OK appears.
  7. Continue with the [NIBP Calibration Check \(p. 131\)](#).

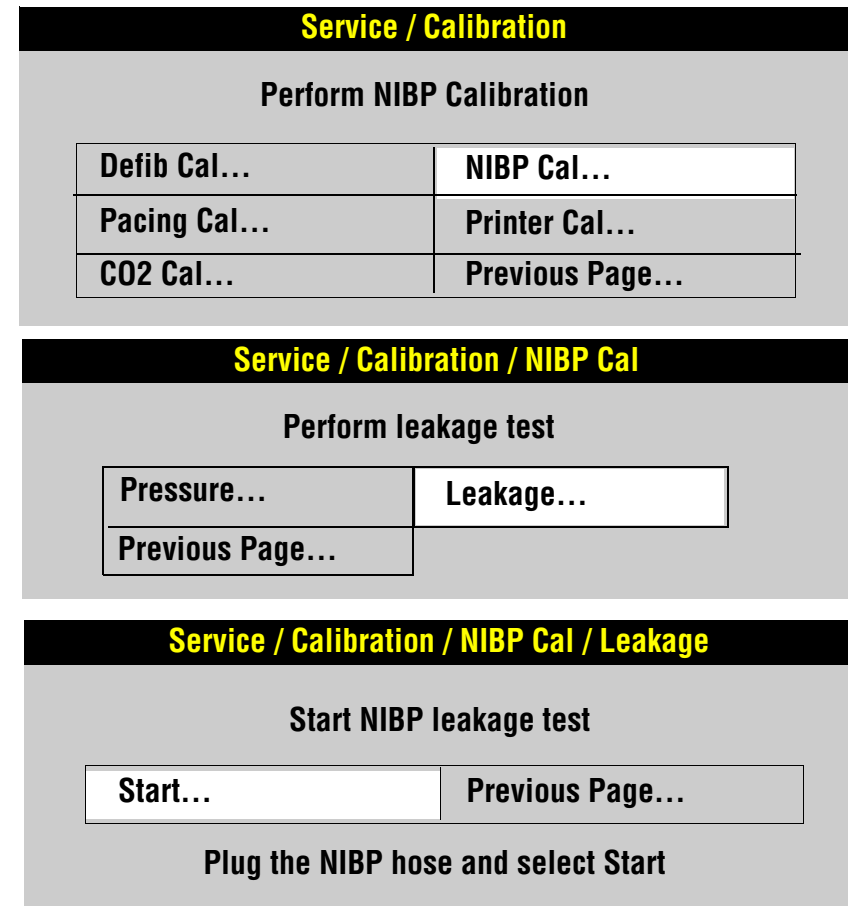

Figure 5.23—NIBP leakage menus

### NIBP Calibration Check

#### CAUTION

POSSIBLE EQUIPMENT DAMAGE Pulling out on the syringe plunger applies a vacuum to the NIBP connection and may damage the LIFEPAK 15 monitor/defibrillator. DO NOT pull on the plunger; only push in on the plunger to inflate the system per the instructions.

- ◆ To check the NIBP static pressure calibration:  
(9 steps, Page 1 of 2)
  1. Select PRESSURE to test the static pressure.
  2. Set up the NIBP calibration kit as shown in Figure 5.24.

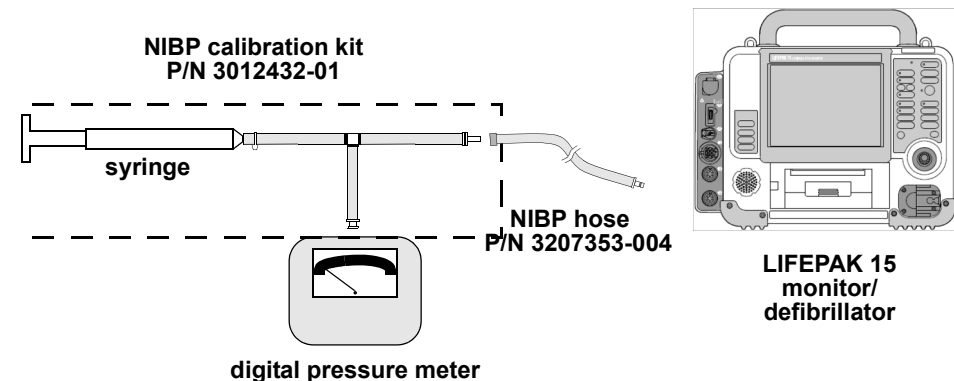
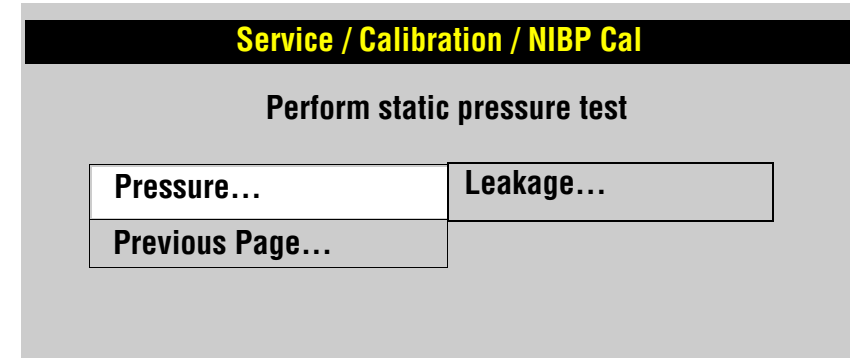

Figure 5.24—NIBP calibration setup

- ◆ To check the NIBP static pressure calibration: (Continued)  
*(9 steps, Page 2 of 2)*
  3. Adjust the pressure meter, if necessary, to a zero initial pressure to ensure that the device and the pressure meter agree.
  4. Using the syringe, inflate the system to each of the following pressures (as indicated on the manometer or pressure meter):

50 mmHg	150 mmHg
±2	±2

5. Verify that the information displayed on the device screen and the external pressure meter agree within  $\pm 2$  mmHg.
6. Using the syringe, **slowly** inflate the system until the overpressure switch activates at 285 mmHg  $\pm 8$  mmHg.
7. Verify that the system depressurizes, and that the NIBP LED turns OFF. The pressure reading at which the overpressure fault occurred remains displayed on the device.
8. Select PREVIOUS PAGE to return to the Service/Calibration/NIBP Cal submenu.
9. Turn the device OFF, and continue with the next test.

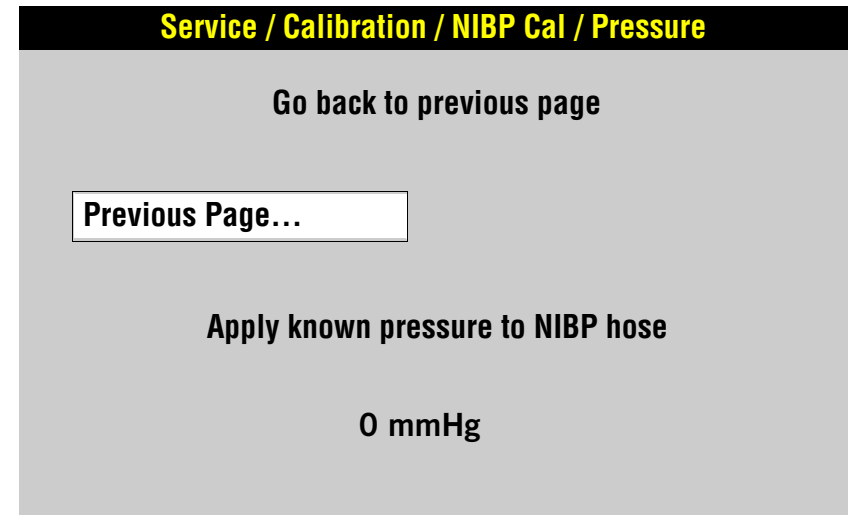

Figure 5.25—NIBP calibration pressure menu



### PIP – Printer Tests

Perform the following printer tests:

- [PIP – Printer Speed Test at 25 mm/sec \(p. 133\)](#)
- [PIP – Printer Speed Test at 12.5 mm/sec \(p. 135\)](#)

### PIP – Printer Speed Test at 25 mm/sec

- ◆ To test the printer speed at 25 mm/sec:  
(8 steps, Page 1 of 2)
  1. Select PRINTER in the Service/Tests submenu.
  2. Select START to print a test strip.
  3. Inspect the test strip for the following attributes:
    - ~ The large “X” form prints without missing dots.
    - ~ Seven horizontal lines print (one very close to the lower paper margin).
    - ~ The character set prints clearly without broken characters.
    - ~ Vertical lines spaced  $25\text{ mm} \pm 1\text{ mm}$  (approx. 24 to 26 mm) apart print correctly.

**NOTE:** Perform the [TCP – Printer Calibration at 25 mm \(p. 211\)](#) if the test results are unacceptable.

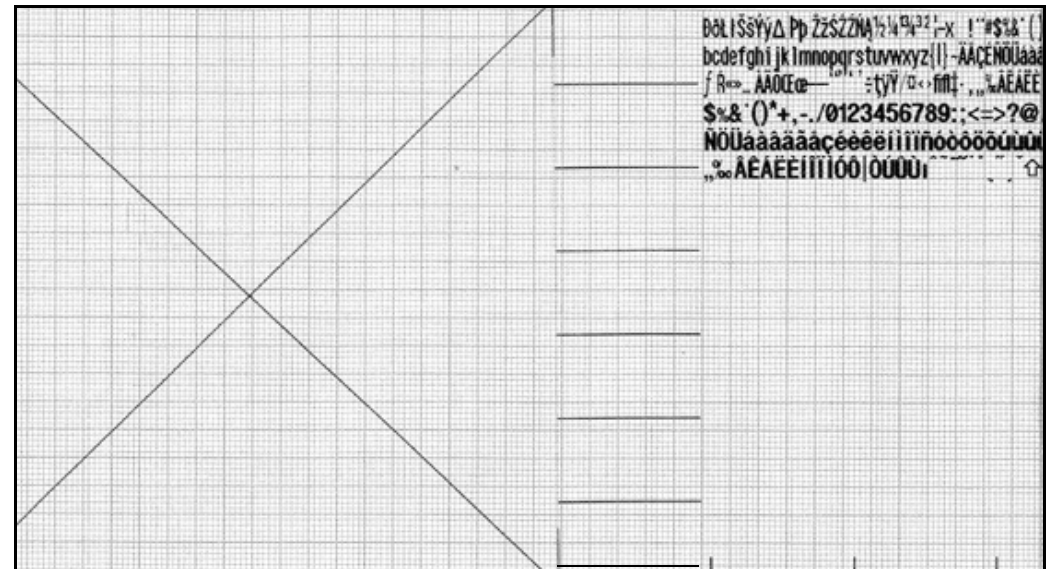

Figure 5.26—Printer test strip

- ◆ To test the printer speed at 25 mm/sec: *(Continued)*  
*(8 steps, Page 2 of 2)*
  4. Open the printer door and verify the CHECK PRINTER message appears at the bottom of the screen.
  5. Remove the printer paper, and then close the printer door.
  6. Verify the CHECK PRINTER message appears at the bottom of the screen.
  7. Select PREVIOUS PAGE twice to return to the Service menu.
  8. Install the printer paper and continue with the next test while still in Service mode.

### PIP – Printer Speed Test at 12.5 mm/sec

- ◆ To test the printer speed at 12.5 mm/sec:
  1. Select CALIBRATION in the Service menu.
  2. Select PRINTER CAL in the Service/Calibration submenu.
  3. Select 12.5 mm/sec for the Speed.
  4. Select START and press the SPEED DIAL to print a test strip.
  5. Verify the interval between tick marks is spaced at 12.5 mm  $\pm$  1 mm (approx. 12 to 13 mm).

**NOTE:** Perform the [TCP – Printer Calibration at 12.5 mm \(p. 212\)](#) if the test results fall outside of the acceptable range.
  6. Press the SPEED DIAL to turn the printer off.
  7. Continue with the next test while still in Service mode.

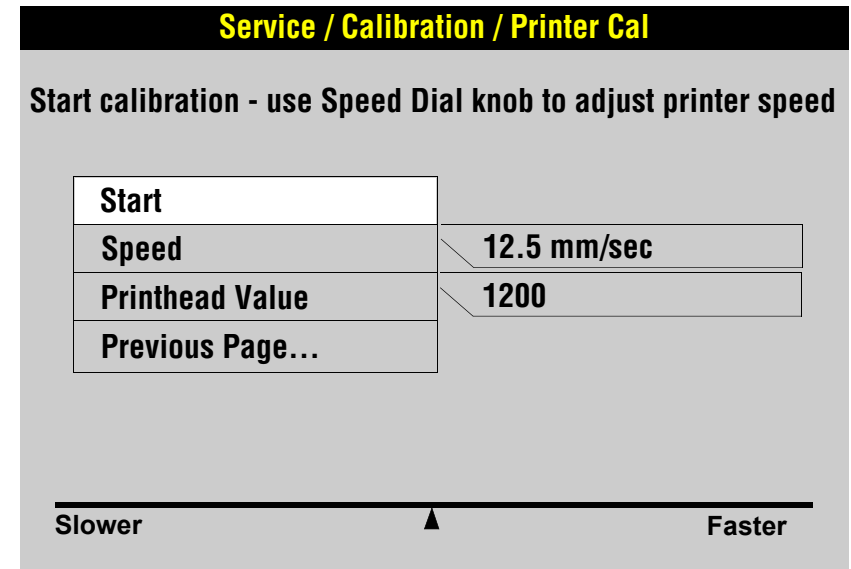

Figure 5.27—Printer speed test calibration submenu

### PIP – Keypad Tests

- ◆ To test the keypads:
  1. Access the Service mode (see [Entering Service Mode \(p. 95\)](#)).
  2. Select TESTS in the Service menu.
  3. Select BUTTONS in the Service/Tests submenu.
  4. Press each front panel button when prompted by the flashing button legend (although you may press the buttons in any order).
  5. Verify with each button pressed that its associated text box is highlighted.  
**NOTE:** A failure is indicated by a text box that is not highlighted. It is normal for the buttons with up/down arrows to highlight only the arrows.
  6. Verify the TEST COMPLETE message appears on the bottom of the screen and the Service LED is not on.
  7. Press SPEED DIAL at the end of the test.
  8. Continue with the next test while still in Service mode.

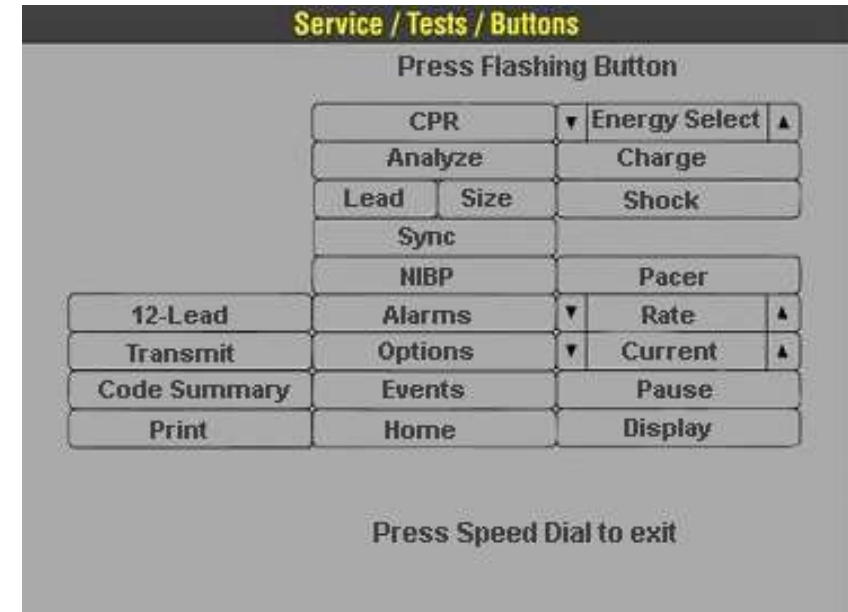

Figure 5.28—Keypad test buttons

## PIP – Audio Test

- ◆ To test the device voice prompts, tones and display:
  1. Select VOICE/TONE from the Service/Tests submenu.
  2. Select START to produce voice prompts from the speaker.
  3. Confirm that the voice prompts are clearly audible and reproduced without distortion.  
**NOTE:** You can listen to a complete replay of all voice prompts and tones, but it is not required for verification of this function.
  4. Turn the device OFF, and continue with the next test.

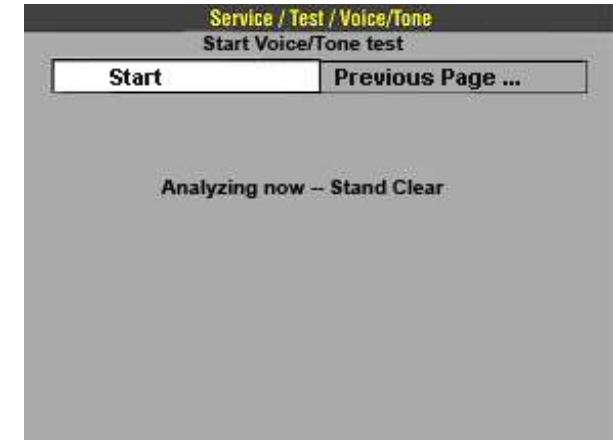

Figure 5.29—Audio test submenu

### PIP – Invasive Pressure Verification - P1, P2

**NOTE:** Perform this test if the device is equipped with the invasive pressure option. Otherwise, skip to [PIP – SpO2/SpCO/SpMet Test \(p. 140\)](#).

◆ To test the invasive pressure:

*(17 steps, Page 1 of 2)*

1. Turn the device ON.
2. Use the invasive pressure cable to connect the patient simulator to the P1 connector on the device parameter bezel.
3. Turn the patient simulator ON, and set the simulator pressure output to ZERO.
4. Use the SPEED DIAL on the device to select P1 in the Mean Arterial Pressure (MAP) display area to display the pressure waveform.
5. On the P1 menu, verify that the scale is set to AUTOSCALE. Select ZERO to zero the P1 pressure channel.
6. Set the patient simulator to produce Static blood pressures.
7. Select 250 mmHg. Verify that the Mean Arterial Pressure (MAP) displays and the pressure waveform reads  $250 \pm 8$  mmHg within a few seconds.
8. Repeat step 7, using the following simulated pressures:
  - 100 mmHg ( $\pm 5$  mmHg)
  - 40 mmHg ( $\pm 4$  mmHg)
  - 20 mmHg ( $\pm 3$  mmHg)



Figure 5.30—Pressure waveform

- ◆ To test the invasive pressure: *(Continued)*

*(17 steps, Page 2 of 2)*

9. With a simulated pressure input of 20 mmHg, use the SPEED DIAL to select P1 in the Mean Arterial Pressure (MAP) display area, and then select ZERO to zero the P1 pressure channel again.
10. Verify that the pressure waveform and the MAP display return to zero.
11. Set the simulator pressure output to ZERO.
12. Verify that the device displays  $-20 \pm 3$  mmHg within a few seconds.
13. Disconnect the invasive pressure cable from the P1 connector and connect it to P2.
14. Select CHANNEL 2, and assign P2 to the display.
15. Repeat steps 4 through 12 above for the P2 pressure channel.
16. Disconnect the invasive pressure cable from the P2 connector.
17. Turn the device OFF, and continue with the next test.

### PIP – SpO2/SpCO/SpMet Test

**NOTE:** Perform this test if the device is equipped with any combination of the SpO2/SpCO/SpMet options. Otherwise, skip to [PIP – Recording Operating Data \(Optional\)](#) (p. 141).

- ◆ To test the SpO2/SpCO/SpMet:
  1. Turn the device ON.
  2. Connect the oximeter finger probe to the SpO2/SpCO/SpMet connector.
  3. Verify the SpO2/SpCO/SpMet parameter region appears on the display.
  4. Place your ring finger into the oximeter finger probe. Allow several seconds for the probe to find your pulse.
  5. Confirm the SpO2 reading is in the range of 50% to 100%.
  6. Highlight SpO2 on the screen and press SPEED DIAL twice. Highlight the parameter and press the SPEED DIAL to select.
    - ~ Confirm the SpCO reading is in the range of 0% to 40%.
    - ~ Confirm the SpMet reading is in the range of 0% to 15%.
  7. Disconnect the oximeter finger probe.
  8. Turn the device OFF, and continue with the next test.

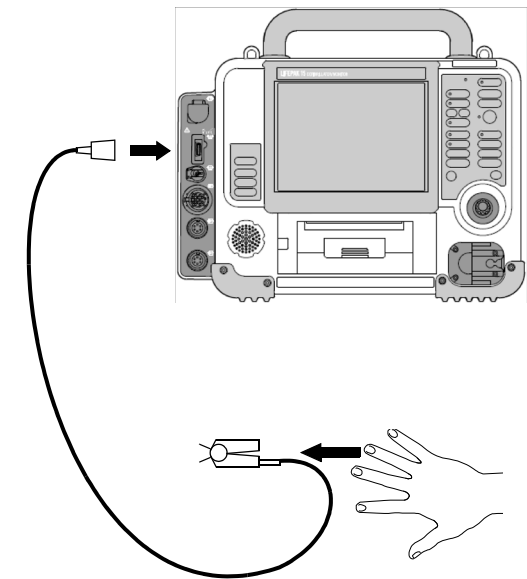
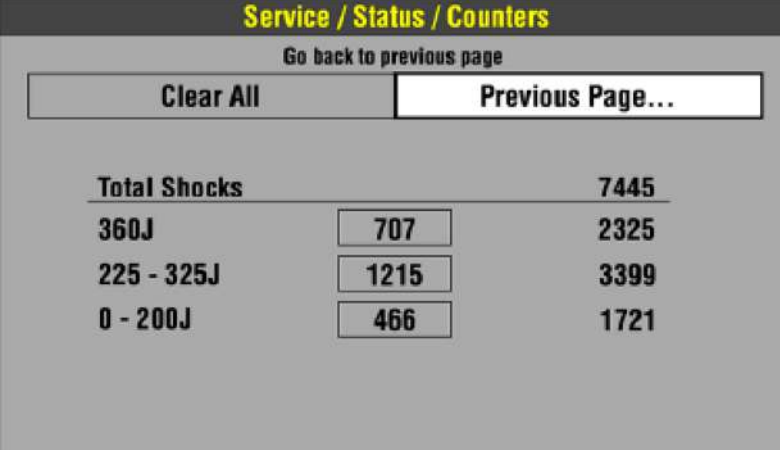

Figure 5.31—SpO2/SpCO/SpMet setup



### PIP – Recording Operating Data (Optional)

- ◆ To record operating data:
  1. Press and hold **OPTIONS** and **EVENT**, and then turn the device **ON**.
  2. When the Setup mode passcode prompt appears, enter 5433.
  3. Select **SERVICE** from the Setup menu, and enter 5433 for the password again.
  4. Select **STATUS** in the Service menu.
  5. Select **COUNTERS** in the Service/Status submenu.
  6. Record the shocks since last reset (in the boxes) and total shocks since the device was built. (Select **CLEAR ALL** to reset boxed counters, if necessary.)
  7. Select **PREVIOUS PAGE**.
  8. Select **DEVICE LOG** and record the following items:
    - Fault Messages
    - Power Cycle Count
    - Pacing Count
    - Shock Count
    - Power On Time
    - Printer On Time
    - SpO2 Operating Time (if SpO2 option is installed)
    - CO2 Operating Time (if CO2 option is installed)
    - NIBP Inflation Cycles (if NIBP option is installed)
  9. Press **SPEED DIAL** to exit. Press **HOME SCREEN** to return to the Service menu.
  10. Continue with the next test while still in Service mode.



The screenshot shows the 'Service / Status / Counters' submenu. At the top, there is a title bar with the text 'Service / Status / Counters' in yellow. Below the title bar, there is a button labeled 'Go back to previous page'. Below that, there are two buttons: 'Clear All' and 'Previous Page...'. The main content is a table with three columns: 'Total Shocks', a column with input boxes, and a column with numerical values. The table has four rows of data.

Total Shocks		
360J	707	2325
225 - 325J	1215	3399
0 - 200J	466	1721

Figure 5.32—Counters submenu

### PIP – ECG Performance Testing

ECG performance testing includes the following:

- [PIP – 12-Lead ECG Tests \(p. 142\)](#)
- [PIP – 5-Lead ECG Tests \(p. 144\)](#)
- [PIP – 3-Lead ECG Tests \(p. 147\)](#)

#### PIP – 12-Lead ECG Tests

**NOTE:** If your device is not equipped with a 12-LEAD button on the small keypad, perform the [PIP – 5-Lead ECG Tests \(p. 144\)](#) or [PIP – 3-Lead ECG Tests \(p. 147\)](#) tests instead.

The following procedures include tests for 12-lead ECG leads-off detection and 12-lead ECG gain.

### PIP - 12-Lead ECG Leads-Off Detection Test

- ◆ To test 12-lead ECG leads-off detection (using the customer's ECG cable, if available):
  1. Connect the main ECG cable with the limb lead and precordial lead attachments, and connect all 10 ECG leads to the patient simulator.
  2. Set the patient simulator output to a 1-mv, 10-HZ sine wave.
  3. Turn the device ON.
  4. Set the LIFEPAK 15 monitor/defibrillator lead selection to Lead II.
  5. Press the 12-LEAD button, and then press the SPEED DIAL twice until the ACQUIRING 12-LEAD message appears.
  6. Remove the RL lead from the patient simulator.
  7. Verify that the device displays an ECG LEADS OFF message and a repeating priority 3 tone sounds when the lead is removed.
  8. Reconnect the RL lead.
  9. Remove the RA lead from the patient simulator.
  10. Verify the device displays an RA LEADS OFF message and a repeating priority 3 tone sounds when the lead is removed.
  11. Reconnect the RA lead.
  12. Repeat step 5 (as needed) and steps 9 through 11 for the LA, LL, and all V leads. Verify the device displays an individual LEADS OFF message when each lead is removed (for example, LA LEADS OFF when the LA lead is removed) and a repeating priority 3 tone sounds when the lead is removed.
  13. Continue to the next test with this setup in place.



Figure 5.33—ECG lead connections

### PIP - 12-Lead ECG Gain Test

- ◆ To test 12-lead ECG gain:
    1. Program the patient simulator output for a 1-mv, 10-Hz sine wave.
    2. Set the LIFEPAK 15 monitor/defibrillator ECG SIZE to 4.0.
    3. Set the device LEAD selection to Lead I.
    4. Print five seconds of ECG Lead I, and confirm the printed signal amplitude is 25 mm to 31 mm, peak-to-peak, as shown in Figure 5.34.
- NOTE:** Depending on the test equipment used, the Lead I amplitude can be 50% or 75% of the Lead II output value. If value is different than range given above, check the test equipment's operation manual for Lead I amplitude specification.
5. Set the LIFEPAK 15 LEAD selection to Lead II.
  6. Print five seconds of ECG Lead II, and confirm the printed signal amplitude is 36 mm to 44 mm, peak-to-peak, as shown in Figure 5.34.
  7. Repeat steps 5 and 6 for Leads V1, V2, V3, V4, V5, and V6.
  8. Turn the printer off.
  9. Continue with the next test.

### PIP – 5-Lead ECG Tests

**NOTE:** If your device is not equipped with a 12-Lead button on the small keypad, and the customer does not use 5-wire cable, perform the [PIP – 3-Lead ECG Tests \(p. 147\)](#) instead.

The following procedures include tests for ECG leads-off detection and ECG gain.

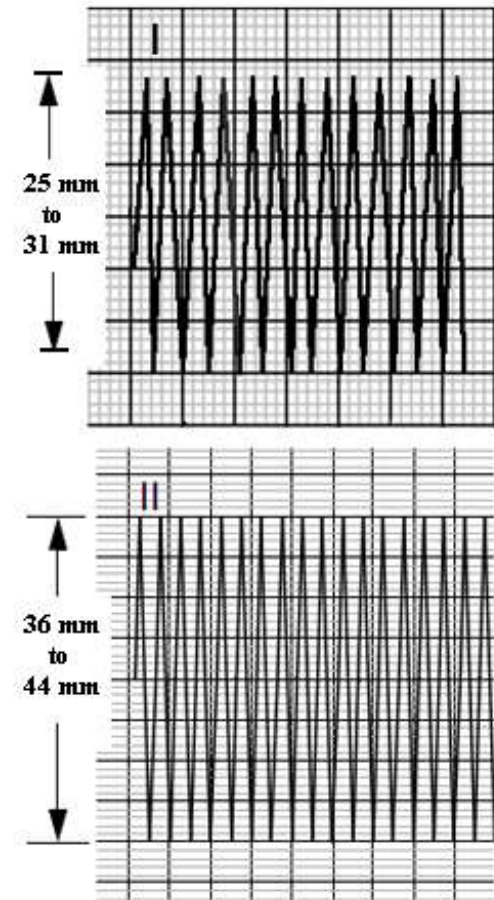

Figure 5.34—Signal amplitude for 12-lead gain test

### PIP - 5-Lead ECG Leads-Off Detection Test

- ◆ To test 5-wire ECG leads-off detection (using the customer's ECG cable):  
*(18 steps, Page 1 of 2)*
  1. Connect the 5-wire ECG cable to the patient simulator.
  2. Set the patient simulator output to a 1-mv, 10-HZ sine wave.
  3. Set the LIFEPAK 15 monitor/defibrillator lead selection to LEAD II.
  4. Remove the LL lead from the patient simulator, and verify that the device displays an LL LEADS OFF message and a repeating priority 3 tone sounds when the lead is removed.
  5. Reconnect the LL lead.
  6. Remove the RA lead from the patient simulator, and verify the device displays an RA LEADS OFF message and a repeating priority 3 tone sounds when the lead is removed.
  7. Reconnect the RA lead.
  8. Remove the RL lead from the patient simulator, and verify that the device displays an ECG LEADS OFF message and a repeating priority 3 tone sounds when the lead is removed.



Figure 5.35—ECG 5-wire connection

- ◆ To test 5-wire ECG leads-off detection (using the customer's ECG cable): *(Continued)*  
*(18 steps, Page 2 of 2)*
  9. Reconnect the RL lead.
  10. Set the device lead selection to LEAD I.
  11. Remove the LA lead from the patient simulator.
  12. Verify that the device displays an LA LEADS OFF message and a repeating priority 3 tone sounds when the lead is removed.
  13. Reconnect the LA lead.
  14. Set the device LEAD selection to LEAD V1/C.
  15. Remove the V1/C lead from the patient simulator.
  16. Verify that the device displays a CHEST LEADS OFF message and a repeating priority 3 tone sounds when the lead is removed.
  17. Reconnect the V1/C lead.
  18. Continue to the next test with this setup in place.

### PIP - 5-Lead ECG Gain Test

- ◆ To test 5-wire ECG gain:
  1. Program the patient simulator output for a 1-mv, 10-Hz sine wave.
  2. Set the LIFEPAK 15 monitor/defibrillator ECG SIZE to 4.0.
  3. Set the device LEAD selection to LEAD I.
  4. Print five seconds of ECG Lead I, and confirm the printed signal amplitude is 25 mm to 31 mm, peak-to-peak, as shown in Figure 5.36.

**NOTE:** Depending on the test equipment used, the Lead I amplitude can be 50% or 75% of the Lead II output value. If value is different than range given above, check the test equipment's operation manual for Lead I amplitude specification.

5. Set the LIFEPAK 15 LEAD selection to LEAD II.
6. Print five seconds of ECG Lead II and confirm the printed signal amplitude is 36 mm to 44 mm, peak-to-peak.
7. Repeat steps 5 and 6 for Lead VI.
8. Turn off the printer.
9. Continue with the next test.

### PIP – 3-Lead ECG Tests

**NOTE:** If your device is equipped with a 12-LEAD button on the small keypad, perform the [PIP – 12-Lead ECG Tests \(p. 142\)](#) instead.

The following procedures include tests for 3-lead ECG leads-off detection and 3-lead ECG gain.

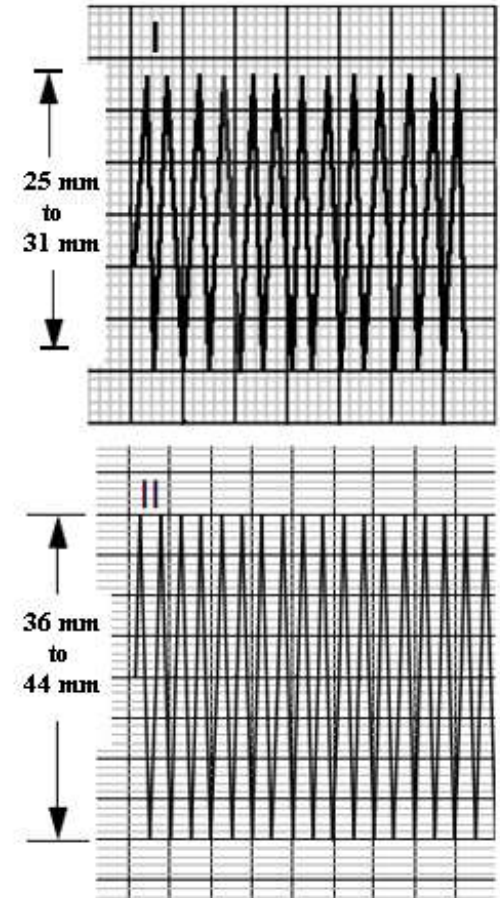

**Figure 5.36—Signal amplitude for 5-lead gain test**



### PIP - 3-Lead ECG Leads-Off Detection Test

- ◆ To test 3-lead ECG leads-off detection (using the customer's ECG cable):
  1. Connect the 3-lead ECG cable between the device and patient simulator as shown in Figure 5.37\*.
  2. Set the patient simulator output to a 1-mv, 10-HZ sine wave.
  3. Set the LIFEPAK 15 monitor/defibrillator LEAD selection to Lead II.
  4. Remove the LL lead from the patient simulator, and verify that the device displays the LL LEADS OFF message and a repeating priority 3 tone sounds when the lead is removed.
  5. Reconnect the LL lead.
  6. Remove the RA lead from the patient simulator, and verify that the device displays the RA LEADS OFF message and a repeating priority 3 tone sounds when the lead is removed.
  7. Reconnect the RA lead.
  8. Remove the LA lead from the patient simulator, and verify that the device displays the ECG LEADS OFF message and a repeating priority 3 tone sounds when the lead is removed.
  9. Reconnect the LA lead.
  10. Continue with the next test with this setup in place.



Figure 5.37—ECG 3-wire connection



### PIP - 3-Lead ECG Gain Test

- ◆ To test 3-lead ECG gain:
    1. Program the patient simulator output for a 1-mv, 10-Hz sine wave.
    2. Set the LIFEPAK 15 monitor/defibrillator ECG SIZE to 4.0.
    3. Set the LEAD selection to LEAD I.
    4. Print five seconds of ECG Lead I and confirm the printed signal amplitude is 25 mm to 31 mm, peak-to-peak, as shown in Figure 5.38.
- NOTE:** Depending on the test equipment used, the Lead I amplitude can be 50% or 75% of the Lead II output value. If value is different than range given above, check the test equipment's operation manual for Lead I amplitude specification.
5. Set the LEAD selection to LEAD II.
  6. Print five seconds of ECG Lead II and confirm the printed signal amplitude is 36 mm to 44 mm, peak-to-peak, as shown in Figure 5.38.
  7. Turn the device OFF, and continue with the next test.

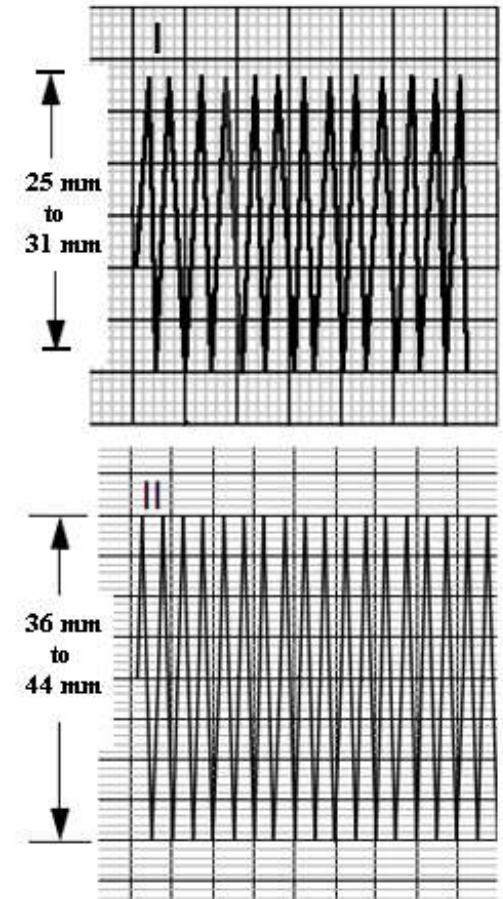

Figure 5.38—Signal amplitude for 2-lead gain test

### PIP – Analog ECG Output Test (Optional)

**NOTE:** Perform this test if this feature is used by the customer. Otherwise, continue with [PIP – QUIK-COMBO Defibrillator Delivered Energy Test](#) (p. 151).

- ◆ To test the ECG analog output:
  1. Connect the device to the patient simulator and oscilloscope as shown in Figure 5.39.
  2. Turn the device ON.
  3. Using the ECG cable supplied with the device, input a 1-mV, 10-Hz sine wave from the patient simulator.
  4. Set the device LEAD selection to LEAD II. (The ECG analog output is in real time at a nominal 1 V/mV and is not affected by the device ECG SIZE setting.)
  5. Verify the amplitude of the signal displayed on the oscilloscope is between 0.90 V<sub>p-p</sub> and 1.10 V<sub>p-p</sub>.
  6. Disconnect the ECG cable from the device and oscilloscope.
  7. Turn the device OFF, and continue with the next test.

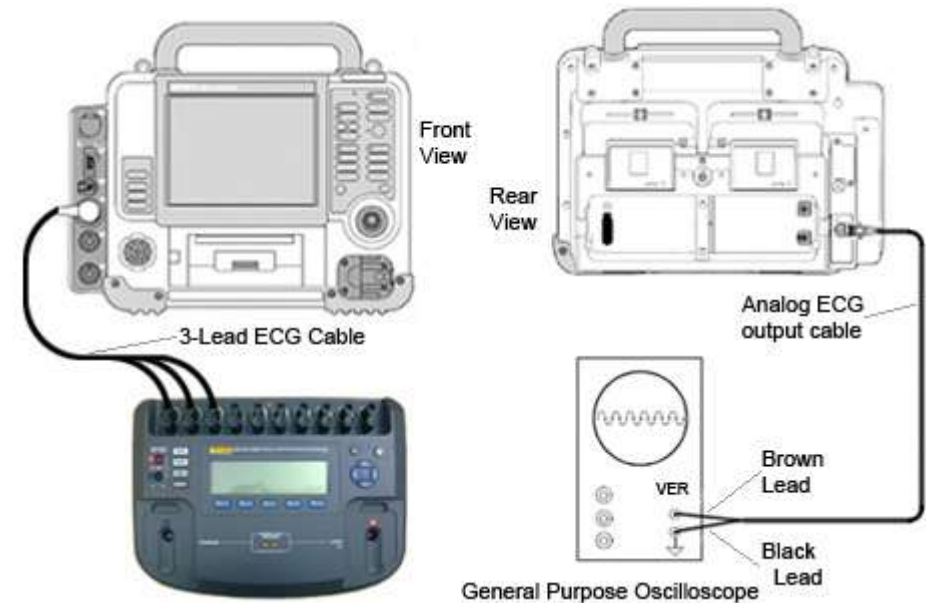

Figure 5.39—Analog ECG output test setup

### PIP – Defibrillator/Pacing Testing

Defibrillator/pacing tests include:

PIP – QUIK-COMBO Defibrillator Delivered Energy Test (p. 151)

PIP - QUIK-COMBO - Defibrillator Charge Time Test and Sync Tests (p. 153)

#### PIP – QUIK-COMBO Defibrillator Delivered Energy Test

Repeat the test for defibrillator delivered energy at 10 J, 200 J, and 360 J.

#### WARNING

**SHOCK HAZARD** Electrical energy is discharged during this procedure. Do not allow the electrodes to contact any person or conductive surfaces except as described below.

- ◆ To test delivered energy using QUIK-COMBO therapy cable:

*(9 steps, Page 1 of 2)*

1. Connect the therapy cable between the device and defibrillator analyzer as shown in Figure 5.40, using the appropriate adapters.
2. Program the defibrillator analyzer to measure an Energy output.
3. Turn the device ON.
4. Press ENERGY SELECT and select 10 J.

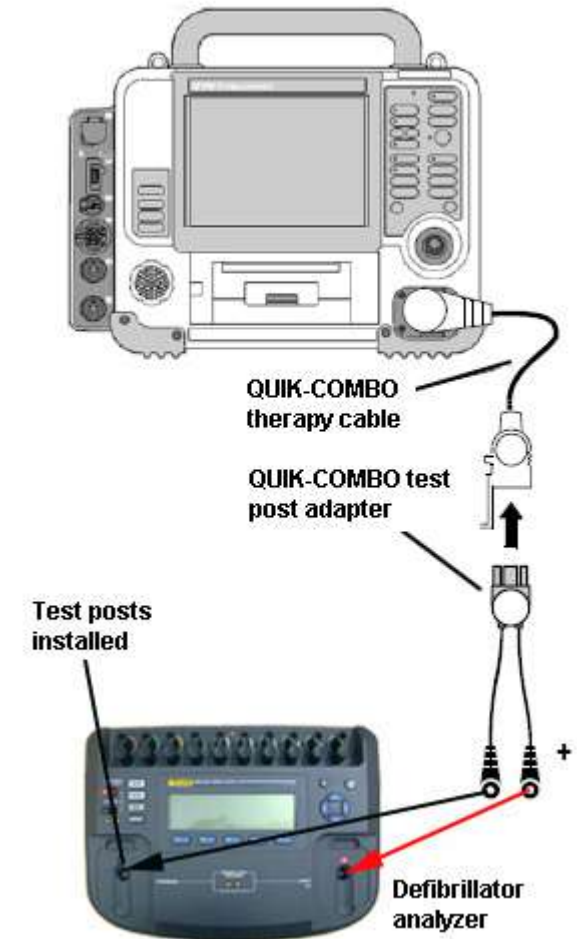

Figure 5.40—QUIK-COMBO delivered energy test setup

- ◆ To test delivered energy using QUIK-COMBO therapy cable: *(Continued)*  
*(9 steps, Page 2 of 2)*

5. Press CHARGE and wait for the device to reach full charge.
6. Press SHOCK to discharge the device into the defibrillator analyzer.
7. Verify the defibrillator analyzer indicates the delivered energy is within the acceptable output limits shown in Table 5.2.

**Table 5.2— Delivered Energy Levels**

Energy Level (J)	Acceptable Output (J)
10	9.1 to 10.9
200	186.0 to 214.0
360	334.9 to 384.9

8. Repeat steps 4 through 7 for the remaining energy levels specified in the table.  
**NOTE:** Perform [TCP – Defibrillator Energy Calibration \(p. 200\)](#) if the delivered energy falls outside the acceptable output range.
9. Continue to the next test with this setup in place.

### PIP - QUIK-COMBO - Defibrillator Charge Time Test and Sync Tests

QUIK-COMBO PIP tests include the following:

- [PIP – Defibrillator Charge Time at 360 J \(p. 154\)](#)
- [PIP – Defibrillator Synchronous Cardioversion Test \(p. 155\)](#)

### PIP – Defibrillator Charge Time at 360 J

#### WARNING

**SHOCK HAZARD** Electrical energy is discharged during this procedure. Do not allow the electrodes to contact any person or conductive surfaces except as described below.

- ◆ To test the device charge time using a stopwatch:
  1. Press ENERGY SELECT on the device and select 360 J.
  2. Press CHARGE and start the stopwatch timer at the same time.
  3. Stop the timer when the device reaches full charge at 360 J.
  4. Verify that the charge time is less than 10 seconds.
  5. Continue with the next test with this setup in place.

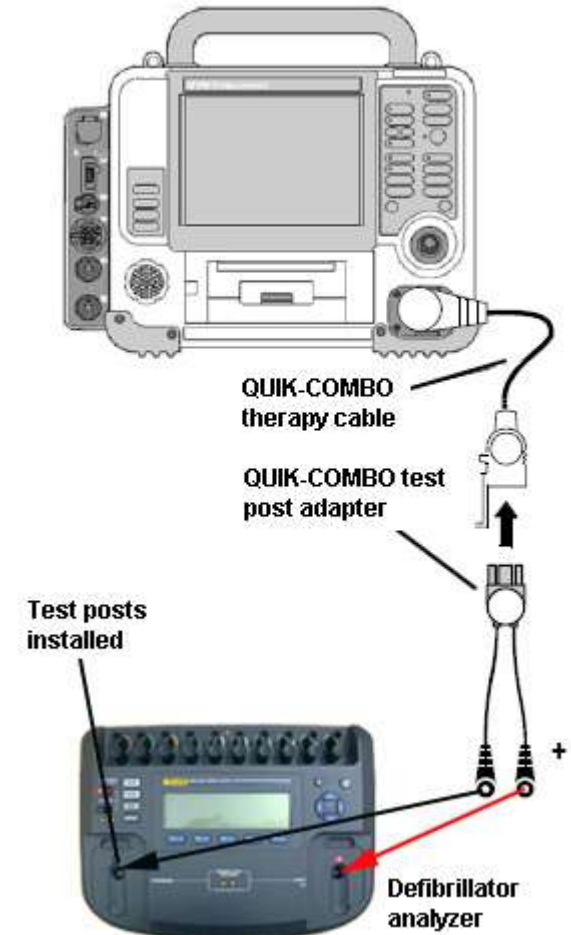

Figure 5.41—Charge time test setup

### PIP – Defibrillator Synchronous Cardioversion Test

#### WARNING

**SHOCK HAZARD** Electrical energy is discharged during this procedure. Do not allow the electrodes to contact any person or conductive surfaces except as described below.

- ◆ To test synchronous cardioversion using QUIK-COMBO therapy cable:
  1. Connect the main ECG cable between the device and the defibrillator analyzer.
  2. Set the device ECG SIZE to 1.0.
  3. Set the LEAD selection to LEAD II.
  4. Set the defibrillator analyzer to measure SYNC, and then press the SYNC button on the LIFEPAK 15 monitor/defibrillator.
  5. Verify that the SYNC LED is on and R-wave markers appear on the ECG waveform.
  6. Charge the device to 10 J. Upon reaching full charge, press SHOCK to discharge the device.
  7. Verify the defibrillator analyzer measures a sync delay of 60 ms or less.
  8. Disconnect the ECG cable from the device and the defibrillator analyzer.
  9. Continue with the next test with this setup in place.

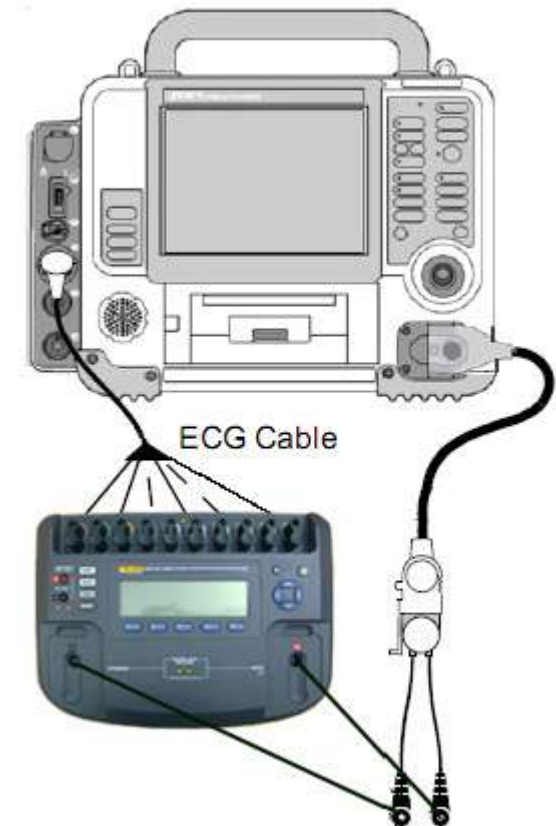

Figure 5.42—Synchronous cardioversion test setup

### PIP – QUIK-COMBO ECG Characteristic Tests

The ECG characteristic tests consist of ECG gain, ECG restore, and A positive R-wave test. These three tests are included here as a single procedure and step numbers are continuous from one step to the next.

- ◆ To test ECG characteristics:  
(20 steps, Page 1 of 3)

#### ECG Gain Test

1. Program the defibrillator analyzer output for a 1-mV, 10-Hz sine wave.
2. Set the LIFEPAK 15 monitor/defibrillator ECG SIZE to 4.0.
3. Set the LEAD selection to PADDLES.
4. Print 10 seconds of paddles ECG. Confirm printed signal amplitude is between 36mm to 44mm, peak to peak.
5. Turn the printer OFF.

#### ECG Restore Test

6. Press ENERGY SELECT on the device and select 360 J.
7. Press PRINT to begin recording.
8. Press CHARGE.

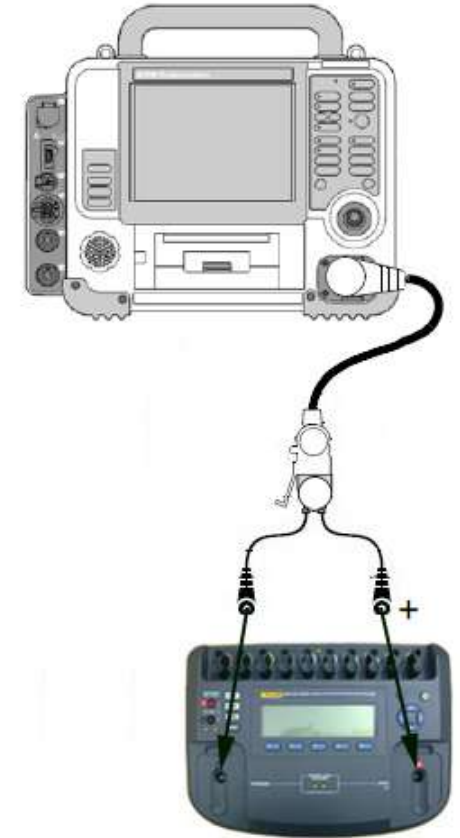

Figure 5.43—QUIK-COMBO ECG characteristic test setup



- ◆ To test ECG characteristics: *(Continued)*  
*(20 steps, Page 2 of 3)*

9. Upon reaching full charge, press SHOCK to discharge the device into the defibrillator analyzer.  
**NOTE:** Allow the printer to run until the defibrillation event and associated sine waveform finish printing.
10. Turn the printer OFF.
11. Verify the Shock # marker and Energy Delivered event marker are recorded on the Paddles printout.
12. Verify the signal baseline on the Paddles printout restores to zero offset within 0.5 seconds of transfer.
13. Verify the amplitude on the Paddles printout restores to >50% of the amplitude restored within 3 seconds.

### A positive R-wave test

14. Impulse 7000DP is programmed for a 1-mv, ECG performance, 60 BPM.
15. Set the LIFEPAK 15 monitor/defibrillator ECG SIZE to 1.0.
16. Set the LEAD selection to PADDLES.

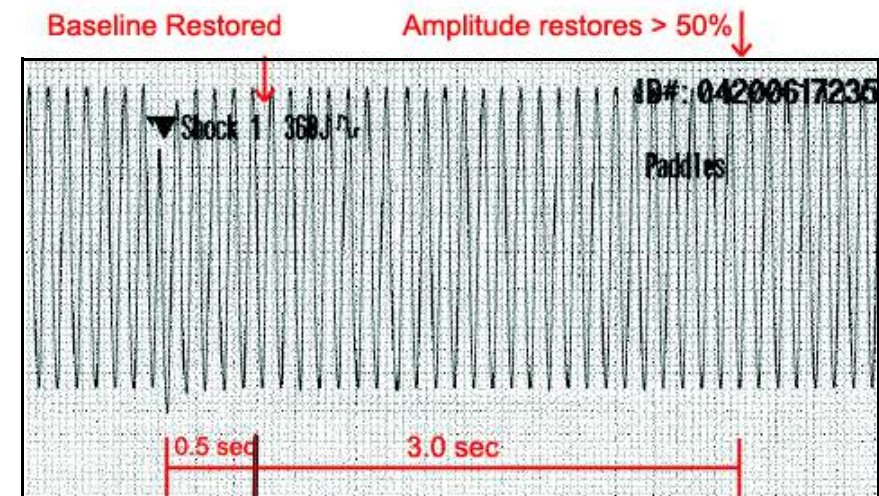

Figure 5.44—QUIK-COMBO ECG restore test printout

- ◆ To test ECG characteristics: *(Continued)*  
*(20 steps, Page 3 of 3)*
  17. Print 10 seconds of paddles ECG recorded on printer paper.
  18. Turn the Printer off.
  19. Confirm the positive R-wave referenced from baseline recorded on printer paper.
  20. Turn the LIFEPAK 15 OFF.

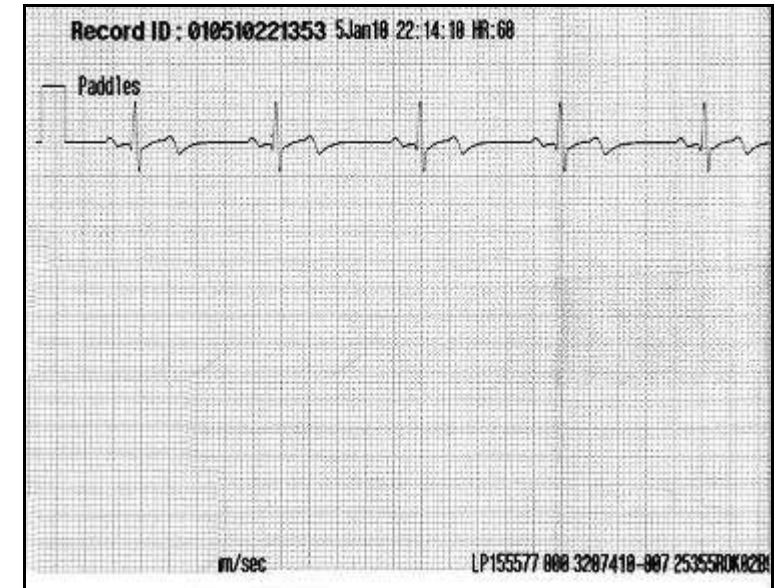

Figure 5.45—QUIK-COMBO ECG A positive R-wave test printout

### PIP – Standard Paddles User Test

**NOTE:** Use the customer's hard paddles (when available). Remove the paddles and check that the paddle surfaces and paddle wells are clean and dry and free of any debris. Check the therapy connector interface for pin damage.

#### WARNING

**SHOCK HAZARD** The conductive gel (wet or dry) on the paddle handles and in the paddle wells may allow the electrical energy to arc between paddles during discharge. Thoroughly clean and dry the paddles and paddle wells after use and before performing the Hard Paddles User Test.

◆ To test the hard paddles:

*(10 steps, Page 1 of 2)*

1. Connect the hard paddles to the device.
2. Place the paddles in the paddle wells.
3. Turn the device ON.
4. Rotate the Sternum paddle ENERGY SELECT dial to select 10 J.
5. Press CHARGE on the Apex paddle.
6. Press only the Apex paddle's SHOCK button and confirm that the defibrillator does not discharge. Release the SHOCK button.

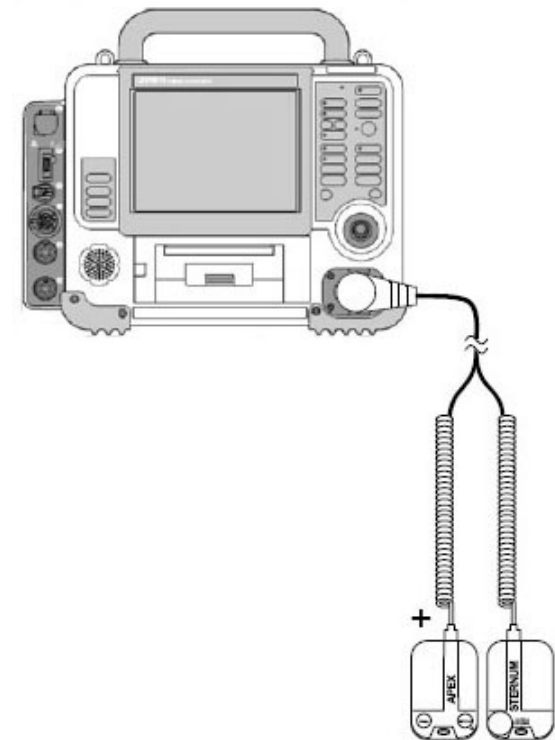

**Figure 5.46—Standard paddles test diagram**

- ◆ To test the hard paddles: *(Continued)*  
*(10 steps, Page 2 of 2)*

7. Press only the Sternum paddle's SHOCK button and confirm that the defibrillator does not discharge. Release the SHOCK button.
8. With the paddles still in the paddle wells, press both SHOCK buttons simultaneously.
9. Confirm the message ABNORMAL ENERGY DELIVERED displays on the screen.
10. Continue with the next test.

### PIP – Standard Paddles Defibrillator Delivered Energy Tests

Perform this test only if the device is equipped with the hard paddles option.

### PIP – Standard Paddles Defibrillator Delivered Energy Tests at 10 J, 200 J, and 360 J

Repeat the test for standard paddles defibrillator delivered energy at 10 J, 200 J, and 360 J.

#### WARNING

**SHOCK HAZARD** Electrical energy is discharged during this procedure. Do not allow the electrodes to contact any person or conductive surfaces except as described below.

Ensure that the Standard Paddles is connected between the LIFEPAK 15 and Impulse 7000DP as shown in Figure 5.47, using the appropriate adapters.

- ◆ To test the standard paddles delivered energy at 10 J, 200 J, and 360 J:  
(7 steps, Page 1 of 2)
  1. Place Standard Paddles onto the defibrillator analyzer as shown in Figure 5.39, using the appropriate adapters.
  2. Program the defibrillator analyzer to measure an Energy output.
  3. Turn the device ON.
  4. Rotate STERNUM PADDLE ENERGY SELECT dial to the level being tested (10 J, 200 J, or 360 J).
  5. Press CHARGE Button on Standard Paddles and wait for the device to reach full charge.

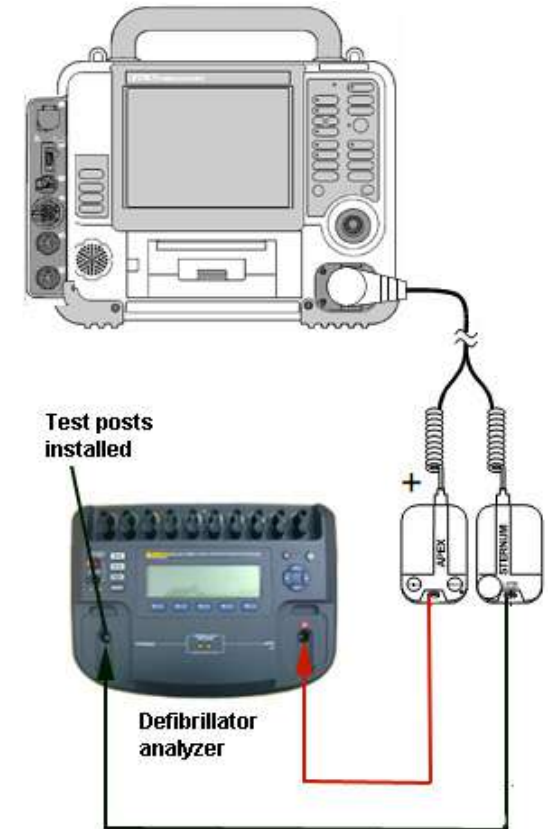

Figure 5.47—Standard paddles defibrillator delivered energy setup

- ◆ To test the standard paddles delivered energy at 10 J, 200 J, and 360 J: *(Continued)*  
*(7 steps, Page 2 of 2)*
- 6. Press SHOCK on Standard Paddles to discharge the device energy.
- 7. Verify the measured delivered energy is between the values for each test level as listed in [Table 5.3](#).

**Table 5.3—Standard Paddles Delivered Energy Test Ranges**

Test Level	Acceptable Range
10J	9.1 to 10.9 J
200J	186.0 to 214.0 J
360J	334.9 to 384.9 J

**NOTE:** Perform the [TCP – Defibrillator Energy Calibration \(p. 200\)](#) if the delivered energy falls outside of the acceptable output range.

### PIP - Standard Paddles - Defibrillator Charge Time and Sync Tests

Perform the following tests for charge time and synchronicity.

- [PIP - Standard Paddles Defibrillator Charge Time Test \(p. 163\)](#)
- [PIP - Standard Paddles Defibrillator Synchronous Cardioversion Test \(p. 164\)](#)

### PIP - Standard Paddles Defibrillator Charge Time Test

Perform this test only if the device is equipped with the hard paddles option.

#### WARNING

**SHOCK HAZARD** Electrical energy is discharged during this procedure. Do not allow the electrodes to contact any person or conductive surfaces except as described below.

- ◆ To test standard paddles defibrillator charge time:
  1. Place Standard Paddles onto the defibrillator analyzer as shown in Figure 5.48, using the appropriate adapters.
  2. Rotate STERNUM PADDLE ENERGY SELECT dial to 360 J.
  3. To test the device charge time using a stopwatch:
    - a. Press CHARGE and start the stopwatch timer at the same time.
    - b. Stop the timer when the device reaches full charge at 360 J.
  4. Verify the charge time is 10 seconds or less.

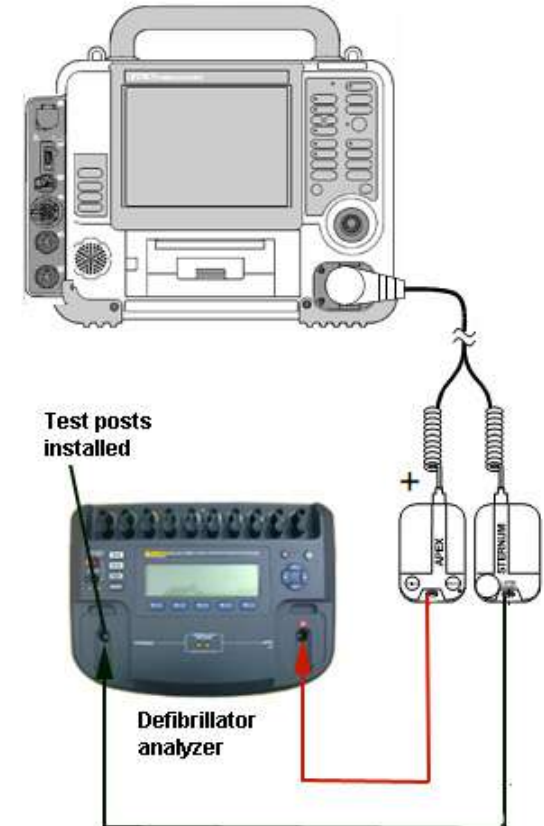

Figure 5.48—Standard paddles defibrillator charge time test setup



### PIP - Standard Paddles Defibrillator Synchronous Cardioversion Test

Perform this test only if the device is equipped with the hard paddles option.

#### WARNING

**SHOCK HAZARD** Electrical energy is discharged during this procedure. Do not allow the electrodes to contact any person or conductive surfaces except as described below.

- ◆ To test synchronous cardioversion
  1. Establish the setup as shown in Figure 5.49.
  2. Set the LIFEPAK 15 ECG SIZE to 1.0.
  3. Set the LEAD selection to Lead II.
  4. Set defibrillator analyzer to measures SYNC.
  5. Press the SYNC button on the LIFEPAK 15 monitor/defibrillator.
  6. Verify that the SYNC LED is on and R-wave markers appear on the ECG waveform.
  7. Press ENERGY SELECT on the device and select 10 J.
  8. Charge the device to 10 J. Upon reaching full charge, press and hold SHOCK key to discharge the device.
  9. Verify the measured sync delay is 60 ms or less.

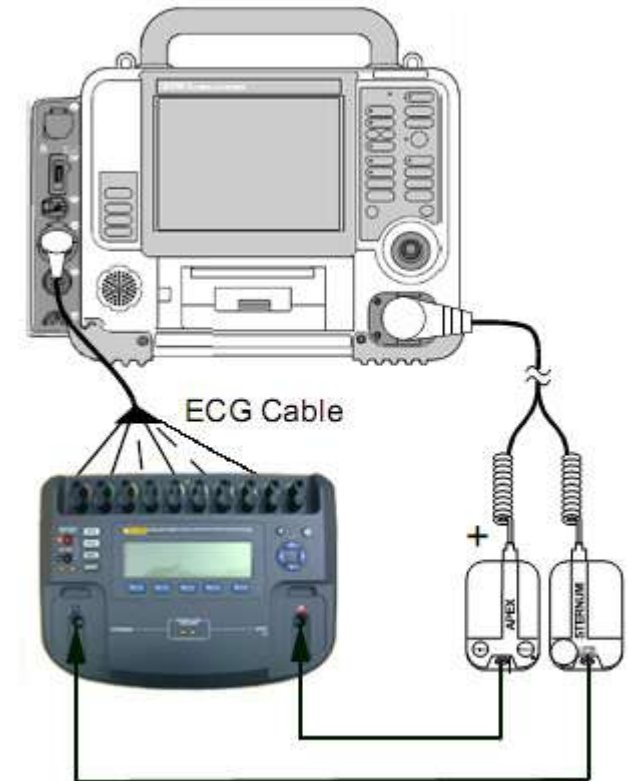

Figure 5.49—Standard paddles defibrillator sync test setup



### PIP - Standard Paddles - ECG Characteristics Tests

The standard paddles ECG characteristics tests consist of three tests combined into this one PIP, restore, and A positive R-wave. Step numbers are continuous from one step to the next.

Perform this test only if the device is equipped with the hard paddles option.

- ◆ To test Standard Paddles ECG characteristics:  
(20 steps, Page 1 of 3)

#### ECG Gain Test

1. Program the defibrillator analyzer output for a 1-mV, 10-Hz sine wave.
2. Set the LIFEPAK 15 monitor/defibrillator ECG SIZE to 4.0.
3. Set the LEAD selection to PADDLES.
4. Print 10 seconds of paddles ECG and confirm the printed signal amplitude is 36 mm to 44 mm, peak-to-peak.
5. Turn the printer OFF.

#### ECG Restore Test

6. Press ENERGY SELECT on the device and select 360 J.
7. Press PRINT to begin recording.
8. Press CHARGE.

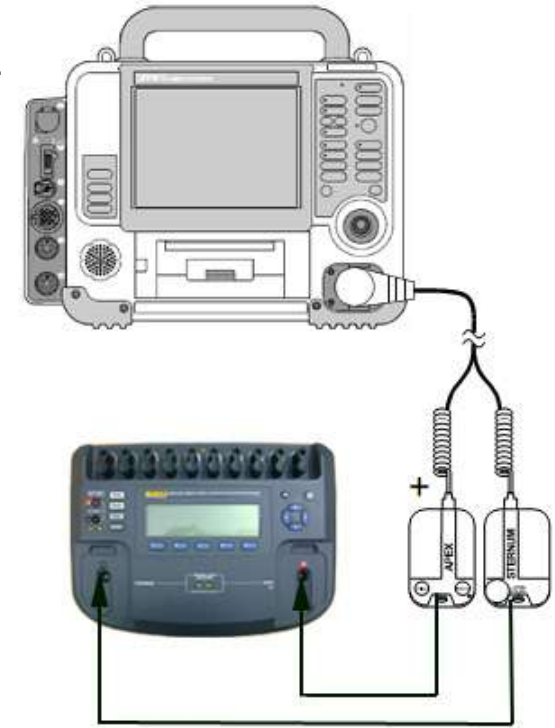

**Figure 5.50—Standard paddles ECG characteristics test setup**

- ◆ To test Standard Paddles ECG characteristics: *(Continued)*  
*(20 steps, Page 2 of 3)*

9. Upon reaching full charge, press SHOCK to discharge the device into the defibrillator analyzer.

**NOTE:** Allow the printer to run until the defibrillation event and associated sine waveform finish printing.

10. Turn the printer OFF.
11. Verify the Shock # marker and Energy Delivered event marker are recorded on the Paddles printout.
12. Verify the signal baseline on the Paddles printout restores to zero offset within 0.5 seconds of transfer.
13. Verify the amplitude on the Paddles printout restores to >50% of the amplitude restored within 3 seconds.

### A positive R-wave test

14. Set defibrillator analyzer for a 1-mv, ECG performance, 60 BPM.
15. Set the LIFEPAK 15 monitor/defibrillator ECG SIZE to 1.0.
16. Set the LEAD selection to PADDLES.

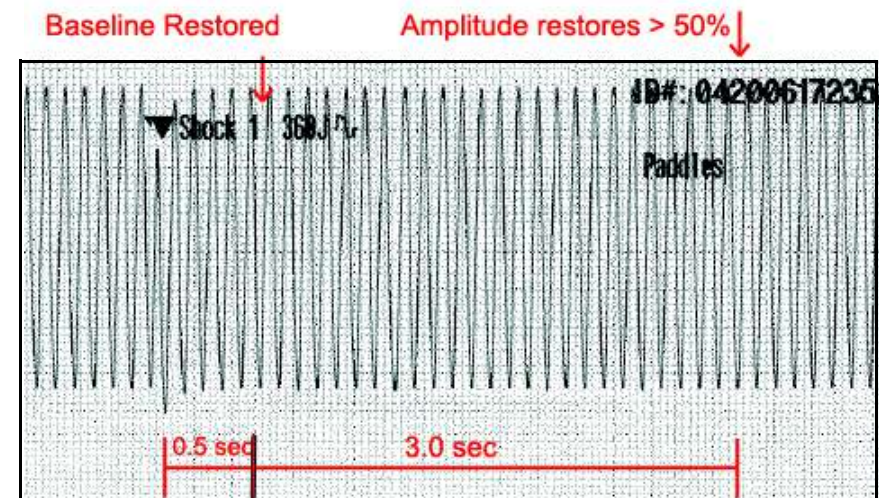

**Figure 5.51—Standard paddles ECG restore test printout**

- ◆ To test Standard Paddles ECG characteristics: *(Continued)*  
*(20 steps, Page 3 of 3)*
  17. Print 10 seconds of paddles ECG recorded on printer paper.
  18. Turn the Printer off.
  19. Confirm the positive R-wave referenced from baseline recorded on printer paper.
  20. Turn the LIFEPAK 15 OFF.

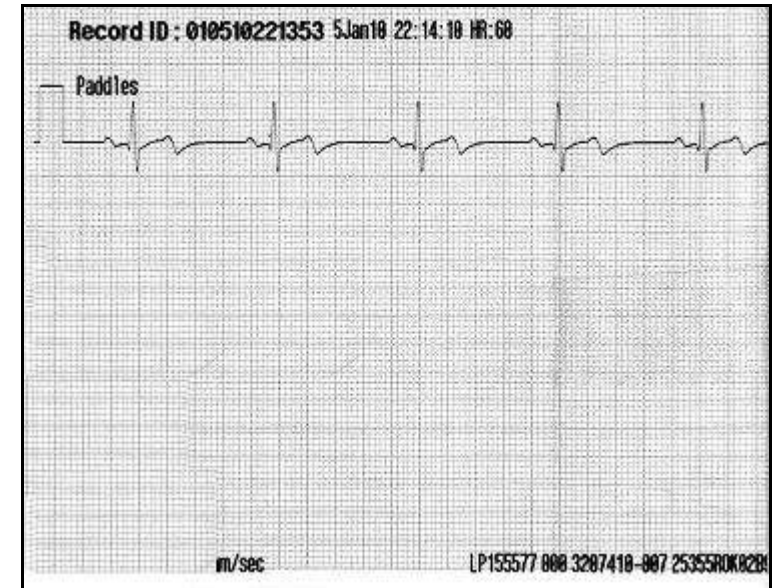

Figure 5.52—Standard paddles ECG A positive R-wave printout

### PIP – Pacer Characteristic Tests

The pacer characteristics include the following:

- [Pacer Leads-Off Detection \(p. 168\)](#)
- [Pacer Output Current Test \(p. 169\)](#)
- [Pacer Pulse Width Test \(p. 170\)](#)

#### Pacer Leads-Off Detection

◆ To test pacer leads-off detection:

1. Establish the setup shown in Figure 5.53.
2. Turn the device ON.
3. Set the defibrillator analyzer to measure peak current pacing parameters.
4. Press PACER on the LIFEPAK 15 monitor/defibrillator.
5. Verify the PACER LED is on and the Pacer overlay appears.
6. Disconnect one of the therapy cable connections from the defibrillator analyzer.
7. Verify the Pacing/Connect Electrodes overlay appears, accompanied by an audible alarm.
8. Reconnect the therapy cable connection. Verify the Pacing/Connect Electrodes overlay disappears and the alarm stops.



Figure 5.53—Pacer leads-off test setup

### Pacer Output Current Test

**NOTE:** Perform the pacer output current test at 10 mA, 100 mA, and 200 mA. You must repeat the test for each current level.

- ◆ To test the pacer output current:
  1. Select Pacer button on Impulse 7000DP to measure pacing current.
  2. In the menu screen, set the Brand to "Medtronic LIFEPAK," Input Jacks to "Defib," and Load to "50 ohm".
  3. Set pacer rate on the device at 60 PPM
  4. Press CURRENT on the device, and select a pacer current (10 mA, then 100 mA, and then 200 mA).
  5. Verify the defibrillator analyzer indicates the pacer output current is within the acceptable output limits shown in Table 5.4 (results may appear as negative numbers).

**Table 5.4—Output Current Levels**

Peak Current Level (mA)	Acceptable Output (mA)
10	5.2 to 14.8
100	95.2 to 104.8
200	190.2 to 209.8

**NOTE:** Perform [TCP – Pacer Self-Calibration \(p. 213\)](#) if the peak pacer current falls outside the acceptable output range.

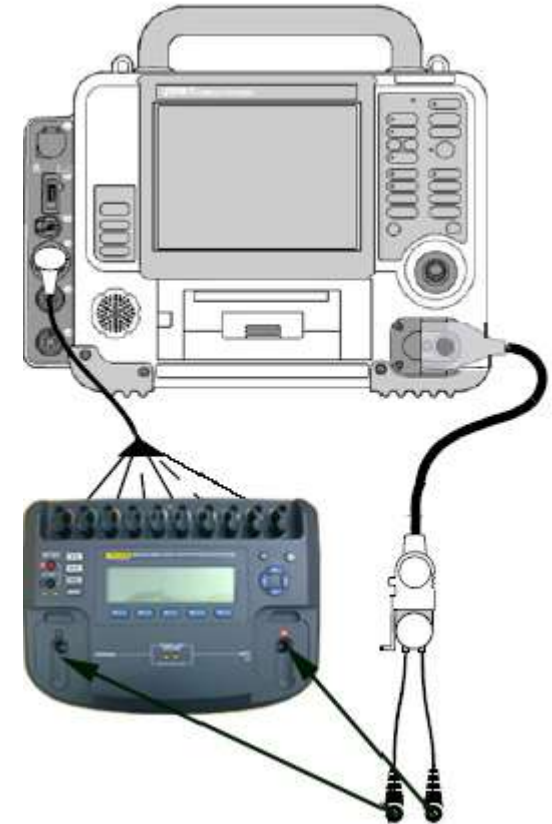

**Figure 5.54—Pacer output current test setup**

### Pacer Pulse Width Test

◆ To test the pacer pulse width:

1. Set pacer rate on the LIFEPAK 15 at 60 PPM
2. Press CURRENT on the device, and select a pacer current of 200 mA.
3. Verify the measured pacer pulse width is between 19.2 and 20.8 ms.

**NOTE:** Perform [TCP – Pacer Self-Calibration \(p. 213\)](#) if the peak pacer current falls outside the acceptable output range.

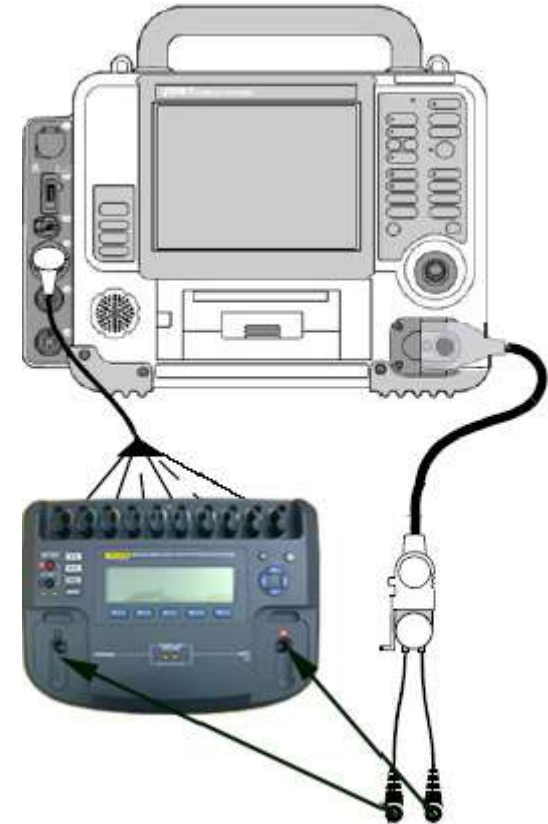

Figure 5.55—Pacer pulse width test setup



### PIP – Patient Impedance Test

- ◆ To test patient impedance sense circuitry:
  1. Connect the QUIK-COMBO therapy cable to the QUIK-COMBO test post adapter cable.
  2. Connect the QUIK-COMBO test post snaps to a decade resistance box, using the appropriate adapters.
  3. Set the decade resistance box to 50 ohms.
  4. Turn the device ON, and set the lead selection to PADDLES.
  5. Verify the PADDLES LEADS OFF message is not visible.
  6. Set the decade resistance box to 370 ohms.
  7. Verify the device displays the PADDLES LEADS OFF message.
  8. Set the decade resistance box to 238 ohms.
  9. Verify the PADDLES LEADS OFF message not visible.
  10. Remove the decade resistance box.
  11. Turn the device OFF and continue with the next test.

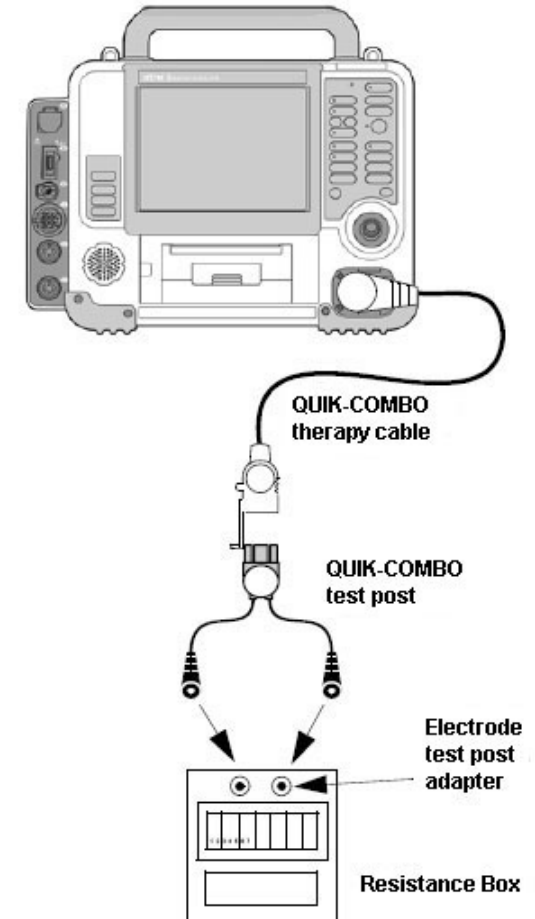

Figure 5.56—Patient impedance test setup

### Data Management

- [PIP – Bluetooth Wireless Technology \(p. 172\)](#)
- [Pairing the LIFEPAK 15 to a Laptop with Bluetooth \(p. 173\)](#)

### PIP – Bluetooth Wireless Technology

Perform these tests if the device is equipped with the Bluetooth wireless technology option.

**NOTE:** If LIFENET Device Communications for CODE-STAT is being used for the first time, perform the TCP-CODE-STAT Device Communication Setup on your computer first.



### Pairing the LIFEPAK 15 to a Laptop with Bluetooth

- ◆ To pair your computer to the device using *Bluetooth* wireless technology: (9 steps, Page 1 of 4)
  1. Ensure the CODE-STAT Reviewer application is open on your computer.
  2. Select DOWNLOAD WIZARD.
  3. Double-click the LIFEPAK 15 icon.
  4. On the LIFENET Download Wizard dialog box, select the SKIP AUDIO DOWNLOAD checkbox (if available), and then click NEXT.
 

**NOTE:** Do not close the CODE-STAT Reviewer application.
  5. Set up your computer as follows:
    - a. Double-click the BLUETOOTH DEVICES icon in the taskbar.
    - b. Select the OPTIONS tab.
    - c. Select the TURN DISCOVERY ON checkbox in the Discovery section. Discovery can now be enabled/disabled using the Fn F2 keyboard combination.
    - d. In the Connection section, select the ALLOW BLUETOOTH DEVICES TO CONNECT TO THIS COMPUTER checkbox and the ALERT ME WHEN A NEW BLUETOOTH DEVICE WANTS TO CONNECT checkbox.
    - e. Select the SHOW THE BLUETOOTH ICON IN THE NOTIFICATION AREA checkbox in the Options section.
    - f. Click APPLY.

**NOTE:** Do not exit the *Bluetooth* wireless technology application on your computer.

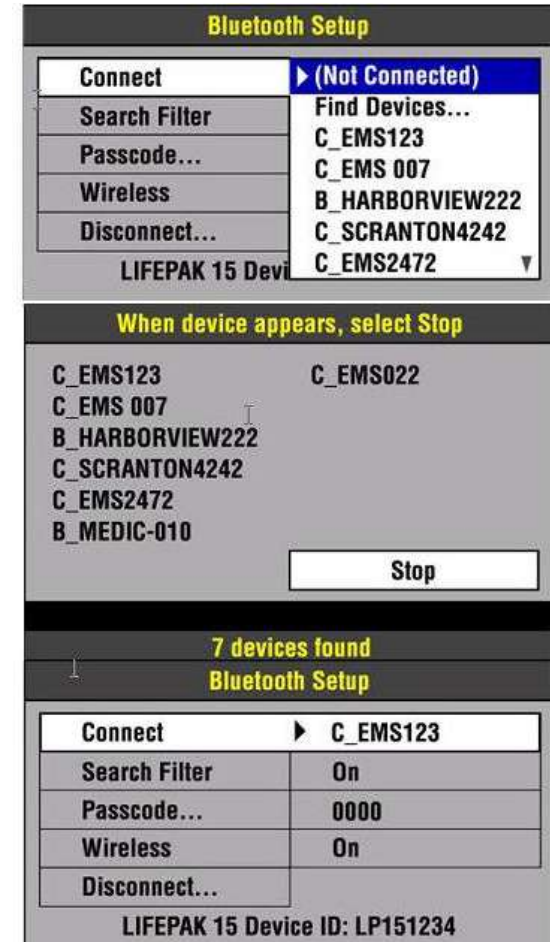

Figure 5.57—Bluetooth menus

- ◆ To pair your computer to the device using *Bluetooth* wireless technology: *(Continued)*  
*(9 steps, Page 2 of 4)*

6. Rename your computer to the Physio Service Class (PSC) name as follows:
  - a. In the BLUETOOTH DEVICES dialog box, select the HARDWARE tab.
  - b. Select BLUETOOTH MODULE and click PROPERTIES.
  - c. Select the ADVANCED tab.
  - d. Insert “B\_” before the current computer name (for example, change SMITHJ1-L2 to B\_SMITHJ1-L2).
  - e. Click OK, and then click OK again to exit the *Bluetooth* wireless technology application on your computer.
7. Pair the device to your computer as follows:
  - a. Turn the device ON.
  - b. Rotate the SPEED DIAL to select the BLUETOOTH icon on the HOME SCREEN, and then press the SPEED DIAL to display the Bluetooth Setup menu.
  - c. Set SEARCH FILTER to ON if you want to find only devices that have the PSC (Physio Service Class); otherwise, set SEARCH FILTER to OFF.
  - d. Make sure WIRELESS is set to ON.

**NOTE:** When *Bluetooth* wireless technology is installed, the default settings for WIRELESS and SEARCH FILTER are ON.

- e. Select CONNECT and then select FIND DEVICES.
- f. The Find Devices menu appears.

- ◆ To pair your computer to the device using *Bluetooth* wireless technology: *(Continued)*  
*(9 steps, Page 3 of 4)*

**Note:** The LIFEPAK 15 monitor/defibrillator begins searching for products in the area that are equipped with *Bluetooth* wireless technology and meet the search filter criteria. The products are displayed under OTHER FOUND, with the most recently found product appearing at the top of the list. If the LIFEPAK 15 monitor/defibrillator is set to WIRELESS OFF, the wireless status changes to WIRELESS ON when FIND DEVICES is selected.

- g. When your computer name (for example, B\_SMITHJ1-L2) appears in the list, use the SPEED DIAL to select STOP and return to the Bluetooth Setup menu.
- h. Use the SPEED DIAL to scroll through the list and select the computer that you want to connect to using Bluetooth wireless.
- i. When the *Bluetooth* wireless technology passcode window appears on your computer, enter the LIFEPAK 15 monitor/defibrillator passcode (default password is 0000).

- ◆ To pair your computer to the device using *Bluetooth* wireless technology: *(Continued)*  
*(9 steps, Page 4 of 4)*

**NOTE:** The passcodes on the LIFEPAK 15 monitor/defibrillator and the computer must match.

- j. When the connection is made, verify that an alert tone sounds, the *Bluetooth* wireless technology LED on the Bluetooth icon on the HOME SCREEN is illuminated, and the CONNECTED TO (*YOUR PC NAME*) message briefly appears in the message area.
8. Turn the LIFEPAK 15 monitor/defibrillator OFF to exit the Bluetooth Setup menu.
  9. Continue to the next test.

**NOTE:** To perform additional Bluetooth wireless tests, refer to [TCP – LIFENET Device Communications Setup \(p. 216\)](#).

### PIP – Leakage Current Tests

Leakage current testing consists of the following sections:

- [Leakage Current Introduction \(p. 177\)](#)
- [PIP - Leakage Tests Battery Powered \(p. 179\)](#)
- [PIP - Leakage Tests AC Powered \(p. 182\)](#)

#### Leakage Current Introduction

Perform leakage current testing in accordance to one of the following electrical safety standards:

- IEC (International Electrotechnical Commission) 62353 for recurrent test and test after repair of medical electrical equipment
- IEC (International Electrotechnical Commission) 60601-1 and 60601-2-4 (60601-1 leakage limits table is provided at end of this procedure)

#### WARNING

**SHOCK HAZARD** Failure to properly perform these tests could result in a failure to detect excessive leakage current. Make sure you are familiar with your test equipment and these test performance procedures.

Leakage – Current flow induced by the application of high voltage to a material or object with high dielectric strength.

Earth Ground – Third wire ground.

Normal Condition (N.C.) – AC voltage is applied in either normal or reversed polarity (that is, measurements made with the POLARITY switch in both NORMAL [NC] and REVERSED [RM] positions). The earth ground is intact during these measurements (if LIFT GND switch is not pressed).

Single Fault Condition (S.F.C.) – AC voltage is applied in either normal or reversed polarity (that is, measurements made with the POLARITY switch in both NORMAL [NC] and REVERSED [RM] positions). The earth ground is NOT intact during these measurements (if LIFT GND switch is pressed).

**NOTE:** Due to the variety of safety analyzers that may be used for these tests, this service manual provides only general instructions. For information about configuration and testing methods, see your safety analyzer operating instructions.

Each test result applies to a safety analyzer operating from a 120-Vac source or 240-Vac source, unless indicated otherwise. For exceptions, the test result includes the safety analyzer operating source. For example, 300  $\mu$ A (120 Vac) or 500  $\mu$ A (240 Vac).

### PIP - Leakage Tests Battery Powered

#### Leakage Currents Battery Powered Setup

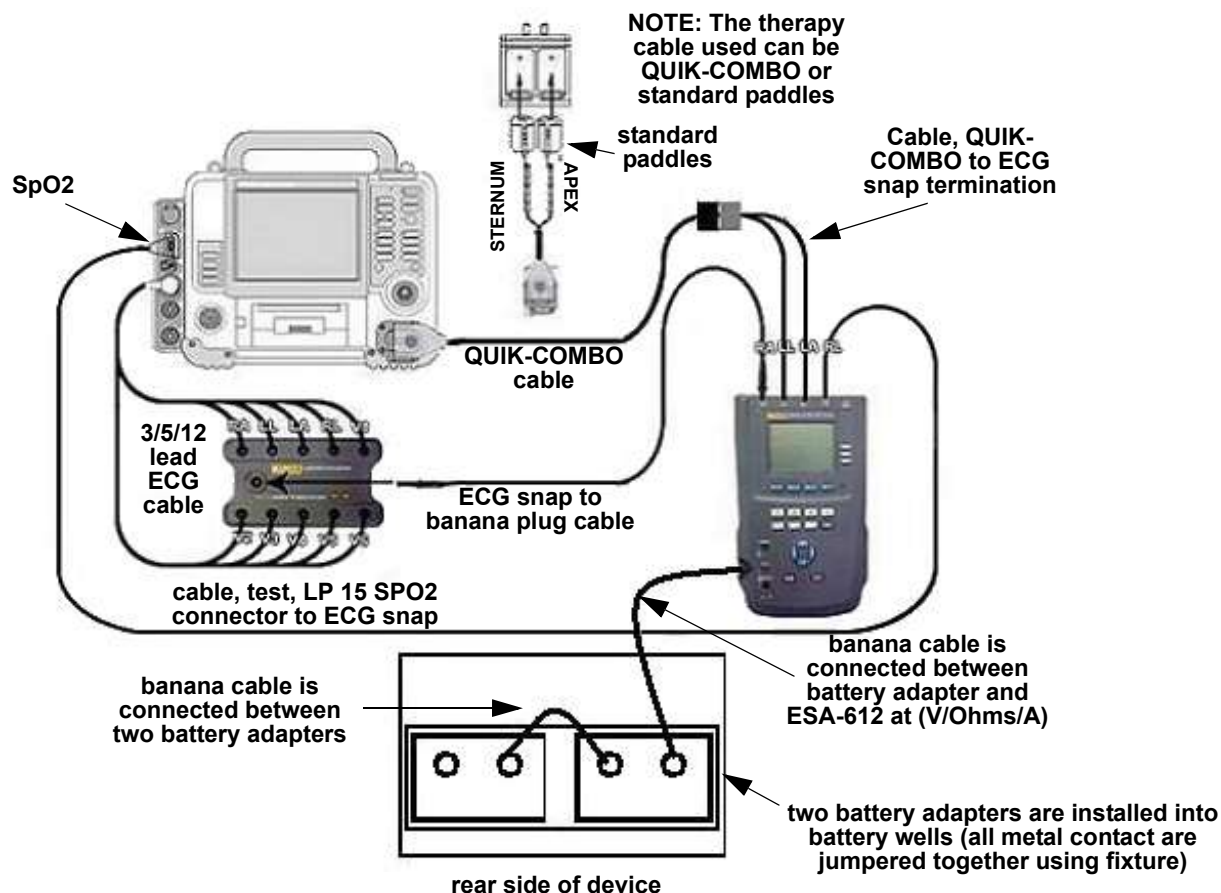

Figure 5.58—Leakage currents setup for battery powered

- ◆ To set up up leakage current test for battery powered (see [Figure 5.58 on p. 179](#)):
  1. Install 2 battery adapters to 2 battery wells of the LIFEPAK 15 monitor/defibrillator.
  2. Connect 2 battery adapters together by using the appropriate connection.
  3. Connect the Banana cable between the Safety Analyzer ESA-612 (at V/ohms/A) and the Battery Adapter.
  4. Connect the customer ECG Lead cable between the LIFEPAK 15 monitor/defibrillator and the 1210 box. Connect the 1210 box to the Safety Analyzer ESA-612 at RA snap. Note: The customer ECG cable is 12 Lead or 5 Lead or 3 Lead.
  5. Connect the Therapy cable (Quik Combo or Standard Paddles) between the LIFEPAK 15 monitor/defibrillator and the Safety Analyzer ESA-612 at LL and LA snaps.
  6. Connect the SpO2 Leakage cable between the LIFEPAK 15 monitor/defibrillator and the Safety Analyzer ESA-612 at RL snap.

### WARNING

Do not defibrillate when the leads are connected to the ESA-612.

Perform leakage current tests for the following applicable conditions when battery powered for direct applied parts at 120 or 240 VAC. Complete the setup ([Leakage Currents Battery Powered Setup \(p. 179\)](#)) and test for limits for 120 or 240 VAC as listed in [Table 5.5 on page 180](#), [Table 5.7 on page 185](#) (for IEC 62353), and [Table 5.8 on page 185](#) (for IEC 60601-1).

**Table 5.5—Leakage Test Battery Powered**

Leakage Test to be Performed	Test Conditions	Test Limits
ECG Direct Applied Part at 120 VAC	Normal	5 - 45 $\mu$ A
	Reversed	5 - 45 $\mu$ A
Therapy (Apex, Sternum) Direct Applied Part at 120 VAC	Normal	5 - 2625 $\mu$ A
	Reversed	5 - 2625 $\mu$ A



**Table 5.5—Leakage Test Battery Powered**

Leakage Test to be Performed	Test Conditions	Test Limits
SPO2 Direct Applied Part at 120 VAC	Normal Reversed	5 - 2625 $\mu$ A 5 - 2625 $\mu$ A
ECG Direct Applied Part at 240 VAC	Normal Reversed	5 - 45 $\mu$ A 5 - 45 $\mu$ A
Therapy (Apex, Sternum) Direct Applied Part at 240 VAC	Normal Reversed	5 - 2625 $\mu$ A 5 - 2625 $\mu$ A
SPO2 Direct Applied Part at 240 VAC	Normal Reversed	5 - 2625 $\mu$ A 5 - 2625 $\mu$ A

### PIP - Leakage Tests AC Powered

#### Leakage Current Test Setup AC Powered (ACPA)

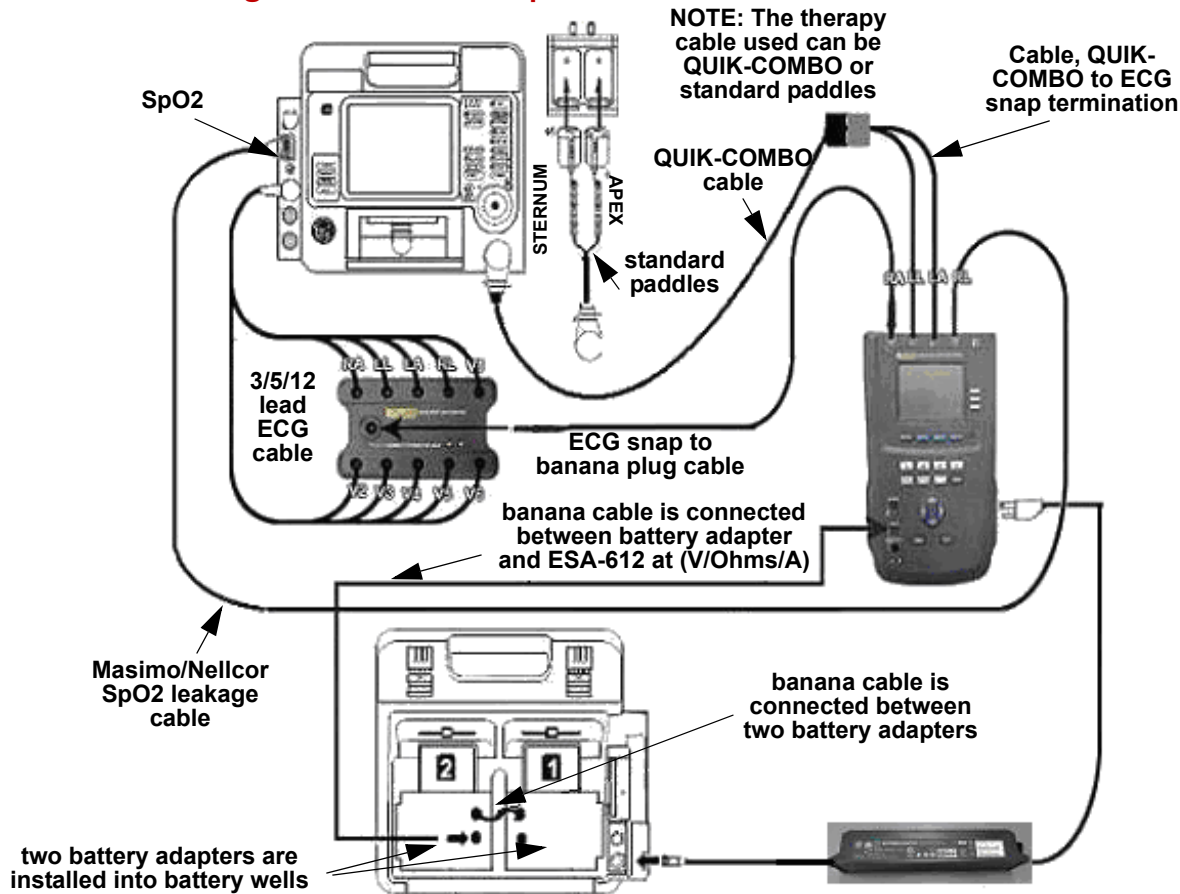

Figure 5.59—Leakage current test (AC) setup

- ◆ To set up leakage current test for AC powered (see [Figure 5.59 on p. 182](#)):
  1. Install 2 battery adapters to 2 battery wells of the LIFEPAK 15 monitor/defibrillator. Connect 2 battery adapters together by using the appropriate connection.
  2. Connect the Banana cable between the Safety Analyzer ESA-612 (at V/ohms/A) and the Battery Adapter.
  3. Connect the customer ECG Lead cable between the LIFEPAK 15 monitor/defibrillator and the 1210 box. Connect the 1210 box to the Safety Analyzer ESA-612 at RA snap. Note: The customer ECG cable is 12 Lead or 5 Lead or 3 Lead.
  4. Connect the Therapy cable (QUIK-COMBO or Standard Paddles) between the LIFEPAK 15 monitor/defibrillator and the Safety Analyzer ESA-612 at LL and LA snaps.
  5. Connect the SpO2 Leakage cable between the LIFEPAK 15 monitor/defibrillator and the Safety Analyzer ESA-612 at RL snap.
  6. Connect the ACPA power cable between the ACPA and the Safety Analyzer ESA-612 at AC output. Connect the ACPA Aux connector to the LIFEPAK 15 monitor/defibrillator.

### WARNING

Do not defibrillate when the Leads are connected to ESA-612.

Perform leakage current tests for the following applicable conditions when AC powered for direct equipment leakage and direct applied parts at 120 or 240 VAC. Complete the setup ([Leakage Current Test Setup AC Powered \(ACPA\) \(p. 182\)](#)) and test for limits for 120 or 240 VAC as listed in [Table 5.6 on page 184](#), [Table 5.7 on page 185](#) (for IEC 62353), and [Table 5.8 on page 185](#) (for IEC 60601-1).

**Table 5.6—Leakage Test AC Powered**

Leakage Test to be Performed	Test Conditions	Test Limits
Direct Equipment Leakage at 120 VAC	Normal, Open Earth	15 -270 $\mu$ A
	Reversed, Open Earth	15 - 270 $\mu$ A
ECG Direct Applied Part at 120 VAC	Normal	5 - 45 $\mu$ A
	Reversed	5 - 45 $\mu$ A
Therapy (Apex, Sternum) Direct Applied Part at 120 VAC	Normal	5 - 2625 $\mu$ A
	Reversed	5 - 2625 $\mu$ A
SPO2 Direct Applied Part at 120 VAC	Normal	5 - 2625 $\mu$ A
	Reversed	5 - 2625 $\mu$ A
Direct Equipment Leakage at 240 VAC	Normal, Open Earth	15 - 450 $\mu$ A
	Reversed, Open Earth	15 - 450 $\mu$ A
ECG Direct Applied Part at 240 VAC	Normal	5 - 45 $\mu$ A
	Reversed	5 - 45 $\mu$ A
Therapy (Apex, Sternum) Direct Applied Part at 240 VAC	Normal	5 - 2625 $\mu$ A
	Reversed	5 - 2625 $\mu$ A
SPO2 Direct Applied Part at 240 VAC	Normal	5 - 2625 $\mu$ A
	Reversed	5 - 2625 $\mu$ A

**Table 5.7—IEC 62353 Leakage Currents Test limit**

Parameter	Max @ 120V, 60HZ	Max @ 240V,50HZ
Direct Equipment Leakage Current	300 $\mu$ A *	500 $\mu$ A
Direct Applied Parts Leakage Current CF type (ECG/ PACE, ECG, Temp, and IP) CF type Internal Paddles	50 $\mu$ A	50 $\mu$ A
Direct Applied Parts Leakage Current BF type (SPO2, CO2, NIBP, External Paddles*) - External Paddles: Hard paddles and QUIK-COMBO cable.	5000 $\mu$ A	5000 $\mu$ A

**Table 5.8—IEC 60601-1 Leakage Currents Test limit**

Parameter	Max @ 120V, 60HZ	Max @ 240V,50HZ
Enclosure Current	NC: 100 $\mu$ A SFC: 300 $\mu$ A	NC: 100 $\mu$ A SFC: 500 $\mu$ A
Earth Leakage Current	NC: 2500 $\mu$ A SFC: 5000 $\mu$ A	NC: 2500 $\mu$ A SFC: 5000 $\mu$ A
Patient Auxiliary current BF type: SPO2, CO2, NIBP, QUIK-COMBO and External Paddles	NC:100 $\mu$ A SFC:500 $\mu$ A	NC:100 $\mu$ A SFC:500 $\mu$ A

**Table 5.8—IEC 60601-1 Leakage Currents Test limit**

Parameter	Max @ 120V, 60HZ	Max @ 240V,50HZ
Patient Auxiliary current CF type: ECG, IP, Temp	NC:100 $\mu$ A SFC:500 $\mu$ A	NC:100 $\mu$ A SFC:500 $\mu$ A
Total Patient Source Leakage current BF type: SPO2, CO2, NIBP, QUIK-COMBO and External Paddles	NC:10 $\mu$ A SFC:50 $\mu$ A	NC:10 $\mu$ A SFC:50 $\mu$ A
Total Patient Source Leakage current CF type: ECG, IP, Temp	NC:50 $\mu$ A SFC:100 $\mu$ A	NC:50 $\mu$ A SFC:100 $\mu$ A
Total Patient Sink Current CF type: ECG ECG, Temp, and IP	SFC:100 $\mu$ A	SFC:100 $\mu$ A
Total Patient Sink Current BF type: SPO2, CO2, NIBP, QUIK-COMBO and External Paddles	SFC:500 $\mu$ A	SFC:5000 $\mu$ A

### PIP – Disabling/Resetting Maintenance Prompt

To disable or reset the maintenance prompt, see [Setting/Resetting the Maintenance Prompt Interval \(p. 270\)](#) in the Preventive Maintenance section.

## Test and Calibration Procedures (TCP)

This section contains the Test and Calibration Procedures (TCP). Perform the procedures in this section as necessary after replacing device components or to correct out-of-specification conditions detected during the PIP. The following procedures may be performed in any order.

**NOTE:** Whenever the device is calibrated or opened for repair or component replacement, it must successfully pass all portions of the closed-case [Performance Inspection Procedures \(p. 98\)](#).

- [TCP – Scope and Applicability \(p. 189\)](#)
- [TCP – Resource Requirements \(p. 190\)](#)
- [TCP – Test Equipment Requirements \(p. 191\)](#)
- [TCP – Setup \(p. 193\)](#)
- [TCP – Service/Calibration Submenu Access \(p. 194\)](#)
- [TCP – Temperature Calibration Test \(p. 195\)](#)
- [TCP – Defibrillator Energy Tests \(p. 199\)](#)
- [TCP – Defibrillator Output Waveform Test \(p. 203\)](#)
- [TCP – Defibrillator Isolation Test \(p. 206\)](#)
- [TCP – CO2 Calibration \(p. 207\)](#)
- [TCP – Printer Calibration Tests \(p. 210\)](#)
- [TCP – Pacer Characteristics Tests \(p. 213\)](#)
- [TCP – LIFENET Device Communications Setup \(p. 216\)](#)



### TCP – Scope and Applicability

This TCP applies to the LIFEPAK 15 monitor/defibrillator exclusively. You may perform the procedures outlined in this section in any order.

**NOTE:** Prior to its return to active use, the LIFEPAK 15 monitor/defibrillator must successfully pass all portions of the closed-case [Performance Inspection Procedures \(p. 98\)](#) (PIP) anytime the device is opened for repair, component replacement, upgrade, or after calibration.

See [TCP – Resource Requirements \(p. 190\)](#) for necessary equipment, test equipment verification, workstation power, and qualifications of the TCP personnel.

See [TCP – Test Equipment Requirements \(p. 191\)](#) for a list of test equipment, including specifications, required to complete the TCP.

### TCP – Resource Requirements

This section describes the requirements for TCP equipment, TCP test equipment verification, TCP workstation power, and TCP personnel.

#### TCP – Equipment

To perform the TCP, you must use the equipment listed in [Table 6.1 on page 191](#). Although the table lists specific test equipment by manufacturer, test equipment with equivalent specifications may be substituted.

**NOTE:** Using test equipment other than that specified in the Test Equipment Requirements table may provide test results that are different from those specified in this manual. It is the responsibility of the biomedical personnel who maintain this device to determine test equipment equivalency.

Use only Physio-Control device accessories, including cables, batteries, and the appropriate Physio-Control battery charger.

#### TCP – Test Equipment Verification

All test equipment used to perform the TCP must have a current calibration label. The calibration label must be issued by a certified calibration facility.

#### TCP – Personnel

Technicians who perform the PIP must be properly qualified and thoroughly familiar with the operation of the LIFEPAK 15 monitor/defibrillator, meeting the requirements described in [Service Personnel Qualifications \(p. 15\)](#).

### TCP – Test Equipment Requirements

The test equipment listed in [Table 6.1](#), or equivalent, is required to conduct the TCP.

**Table 6.1—List of Test Equipment**

Equipment	Specifications or Description	Manufacturer or Part Number
Defibrillator analyzer with external noninvasive pacer measurements <sup>a</sup>	Energy range: 0 to 450 J Load resistance: 50 $\Omega$ $\pm$ 1% Accuracy: $\pm$ 2% +2 J Waveforms: NSR, VF, and sine wave Amplitude: 1.1 mV $\pm$ 10%	Fluke <sup>®</sup> Biomedical Impulse 7000DP with QUIK-COMBO adapter accessory 16/7 D/P ADPT104*
Lithium-ion battery pak	Li-ion battery with fuel gauge	Physio-Control P/N 3206735
Defibrillator isolation test load	Resistor test load: 200 ohms, 50 W, 5%	Physio-Control P/N 3205570
QUIK-COMBO therapy cable		Physio-Control P/N 3207047
Fast-Patch cable assembly	Connects QUIK-COMBO to test posts	Physio-Control P/N 3011030
Electrode test posts (2 ea)		Physio-Control P/N 3205979
Test lead	Alligator clip to alligator clip	
Tubing assembly - CO2 calibration		Physio-Control P/N 3012430-01
Calibration gas	5% CO2, balance N2	Physio-Control P/N 3012556
FilterLine H set, adult/pediatric		Physio-Control P/N 3012176/XS-04660
Temperature probe simulator	Accuracy $\pm$ 0.05 degrees C for all settings	Fogg TP 400

**Table 6.1—List of Test Equipment (Continued)**

Equipment	Specifications or Description	Manufacturer or Part Number
Cable Assembly, Temperature Adapter		Physio-Control P/N 3303938-000
Fogg TP400 Interface cable		Physio-Control P/N 3308413

a. Some energy meters are not accurate for biphasic waveforms; for more information, contact your defibrillator analyzer manufacturer.

\*Equivalent equipment is required to meet the specifications listed in the specification column.

## TCP – Setup

The following describes the LIFEPAK 15 monitor/defibrillator setup for the TCP.

### WARNING

**SHOCK HAZARD** When discharged during this TCP, the device discharges up to 360 joules of electrical energy through the defibrillator cable. You must safely discharge this electrical energy as described in this TCP. Do not attempt to perform this procedure unless you are thoroughly familiar with the operation of the device.

◆ To set up the LIFEPAK 15 monitor/defibrillator for the TCP:

1. Insert two fully functional batteries in the device. A functional battery is one that does not return a LOW BATTERY message when the device is turned ON.
2. Verify that each battery clicks into position in the rear panel battery wells.
3. Install a roll of paper in the printer.

**NOTE:** If you replace the A12 Printer, be sure to record the printhead resistance value located on the label inside the printer door before installing the new printer.

**NOTE:** Do not connect anything to the therapy connector except as directed during these procedures.

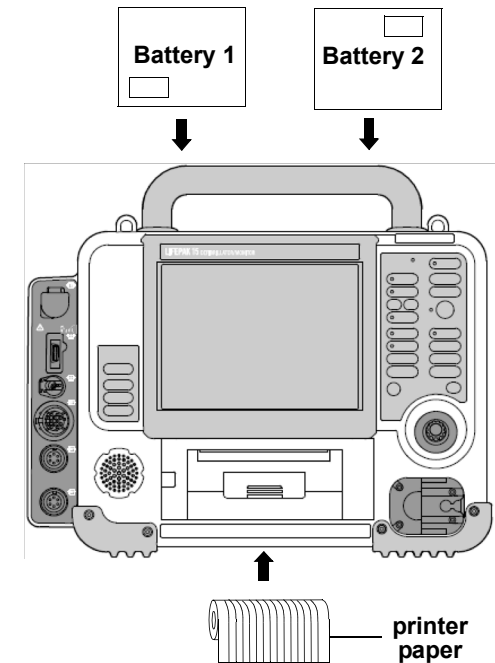

Figure 6.1—TCP setup

### TCP – Service/Calibration Submenu Access

- ◆ To display the Service/Calibration submenu after performing [TCP – Setup \(p. 193\)](#).
  1. Access the service mode as described in [Entering Service Mode \(p. 95\)](#).
  2. Select CALIBRATION from the Service menu to display the Service/Calibration submenu.

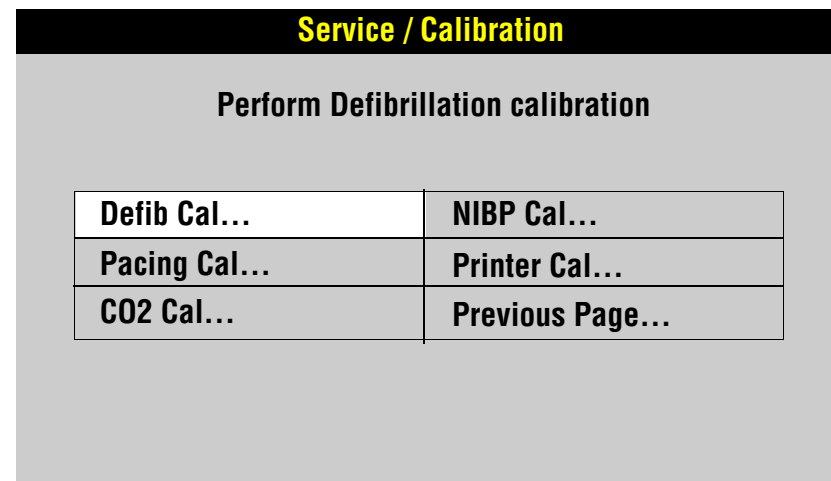

Figure 6.2—Calibration submenu

### TCP – Temperature Calibration Test

- ◆ To perform the temperature calibration test:
  1. Turn the device ON.
  2. Access the Service mode (see [Entering Service Mode \(p. 95\)](#)).
  3. Select CALIBRATION from the Service menu. The screen shown in Figure 6.3 appears.

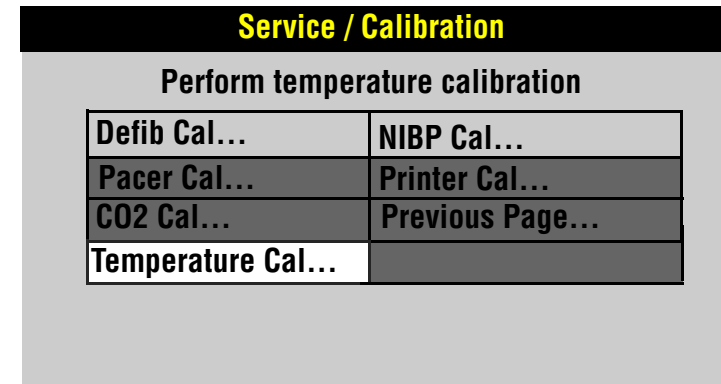

Figure 6.3—Calibration selection

- ◆ To perform the temperature calibration test:
  4. Select the Temperature Cal from the Service /Calibration menu. The screen shown in Figure 6.4 appears.
  
  
  
  
  
  
  
  
  
  
  5. To initiate Temperature Calibration Check, select Calibrate from the Service / Calibration / Temperature Cal menu. The screen shown in Figure 6.5 appears.

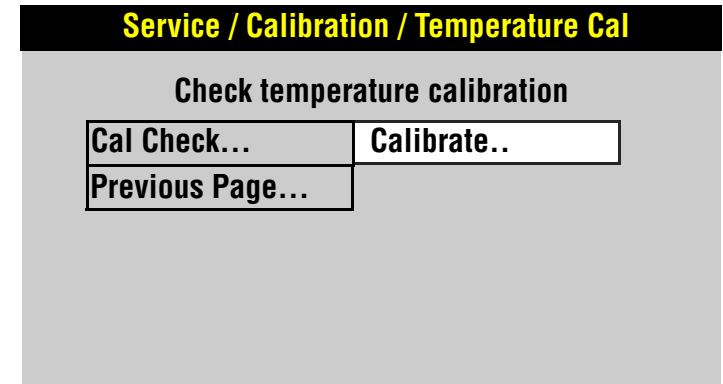

Figure 6.4—Temperature calibration selection

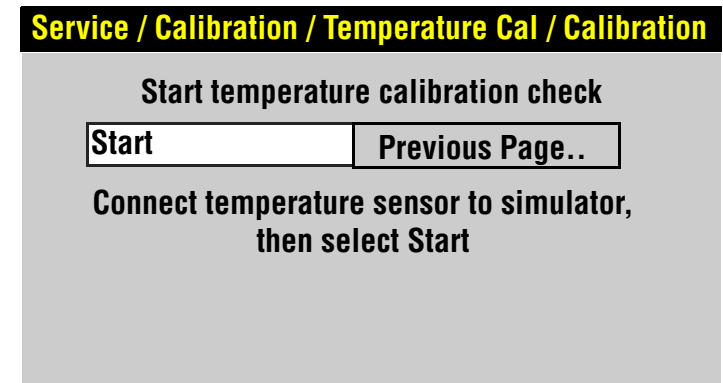
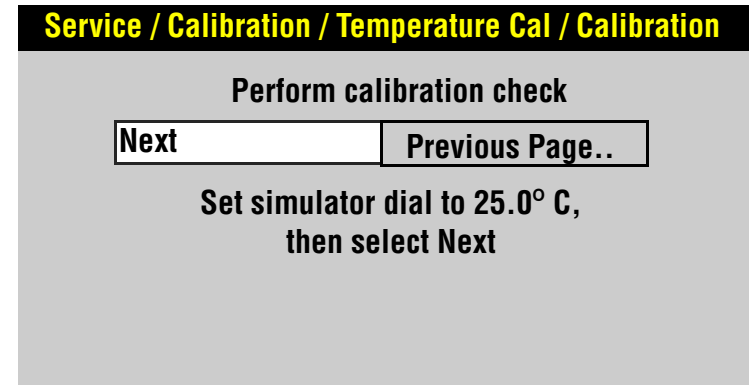

Figure 6.5—Starting calibration check



- ◆ To perform the temperature calibration test:
  6. Connect the temperature sensor to the device and select the Start button. The screen shown in Figure 6.6 appears.



**Figure 6.6—Calibration checking**

7. After NEXT is selected, the text, CALIBRATING... appears on the screen centered about the SET SIMULATOR text.
8. The CALIBRATING ... text is removed when calibration at 25.0° is complete and steps 2 and 3 are repeated, but with 45.0° instead of 25.0°.

◆ To perform the temperature calibration test:

9. The CALIBRATING ... text is removed when calibration at 45.0° is complete and steps 2 and 3 are repeated again, but with 37.0°
10. When the calibration is complete, the screen shown in Figure 6.7 appears.

**NOTE:** Note the following:

- If the calibration fails, the screen will look like the previous screen except that the text message above the temperature value will be CALIBRATION FAILED.
- If Temperature calibration fails and the device is put back into normal use by the servicing agency, the Temperature module will be disabled when the device is next powered on.
- An XXX will appear in the Temperature parameter region in place of the Temperature value and will remain through power cycles until the module is no longer disabled.
- This failure will not generate a service light when the device is powered up in the normal operating mode.

**NOTE:** Temperature calibration will be left unchanged if the calibration fails because the user steps through the process without a simulator, or uses incorrect settings. This prevents the temperature channel from being disabled accidentally as a result of improper calibration procedures.

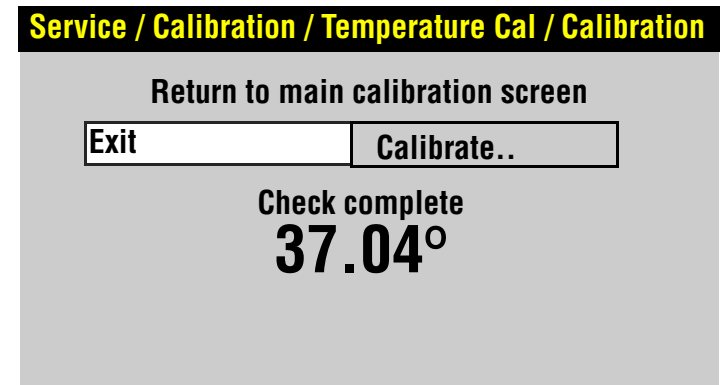

**Figure 6.7—Calibration completion**

### TCP – Defibrillator Energy Tests

Defibrillator energy tests include:

- [TCP – Defibrillator Energy Calibration \(p. 200\)](#)
- [TCP – Delivered Energy Verification Test \(p. 201\)](#)

### TCP – Defibrillator Energy Calibration

#### WARNING

**SHOCK HAZARD** Avoid contact with the energy meter. Dangerous voltages are present on energy meter electrode plates/posts.

- ◆ To perform the defibrillator calibration procedure:
  1. Connect the device to the defibrillator analyzer. Make sure the therapy cable (+) terminal is connected to apex (+).  
**NOTE:** Adapt this procedure to use hard paddles, if desired.
  2. Set the defibrillator analyzer to measure ENERGY, using the appropriate scale.
  3. Turn the LIFEPAK 15 monitor/defibrillator ON.
  4. Select DEFIB CAL from the Service/Calibration submenu. See [TCP – Service/Calibration Submenu Access \(p. 194\)](#).
  5. Select START to initiate the calibration routine.
  6. Follow the instructions on the device screen.
  7. Turn the device OFF when the calibration procedure is complete.
  8. Continue with the [TCP – Delivered Energy Verification Test \(p. 201\)](#) with this setup in place.

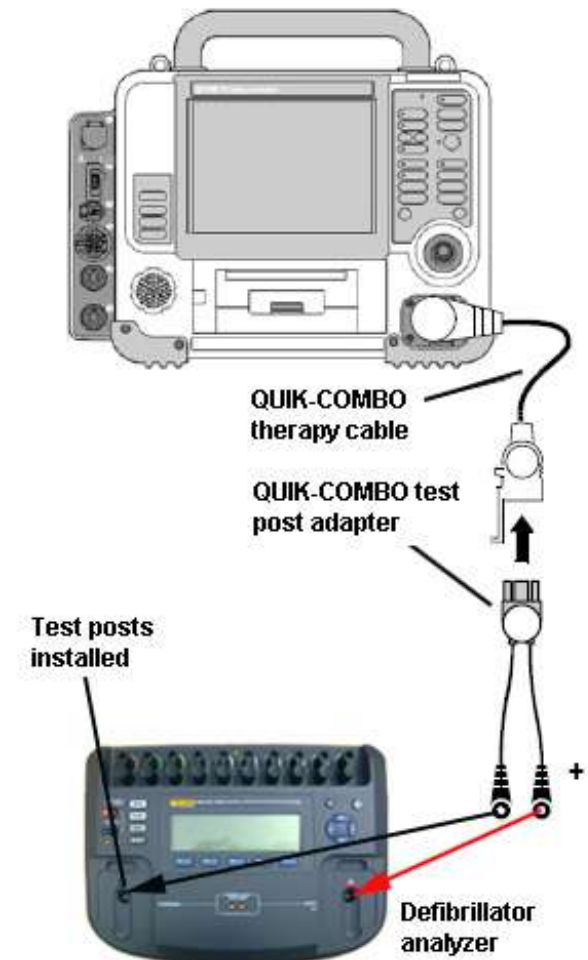

Figure 6.8—Energy calibration setup

### TCP – Delivered Energy Verification Test

Perform the delivered energy verification test at 2 J, 10 J, 100 J, 200 J, and 360 J.  
Instructions here are for all energy levels.

#### WARNING

**SHOCK HAZARD** Avoid contact with the energy meter. Dangerous voltages are present on energy meter electrode plates/posts.

- ◆ To verify the defibrillator delivered energy: *(8 steps, Page 1 of 2)*
  1. Connect the device to the defibrillator analyzer as described in [TCP – Defibrillator Energy Calibration \(p. 200\)](#).  
**NOTE:** Adapt this procedure to use hard paddles, if desired.
  2. Set the defibrillator analyzer to measure ENERGY, with the appropriate scale.
  3. Turn the LIFEPAK 15 monitor/defibrillator ON.
  4. Press ENERGY SELECT and select energy level (2, 10, 100, 200, or 360 J).
  5. Press CHARGE and wait for the device to reach full charge.
  6. Press SHOCK to discharge the device energy.

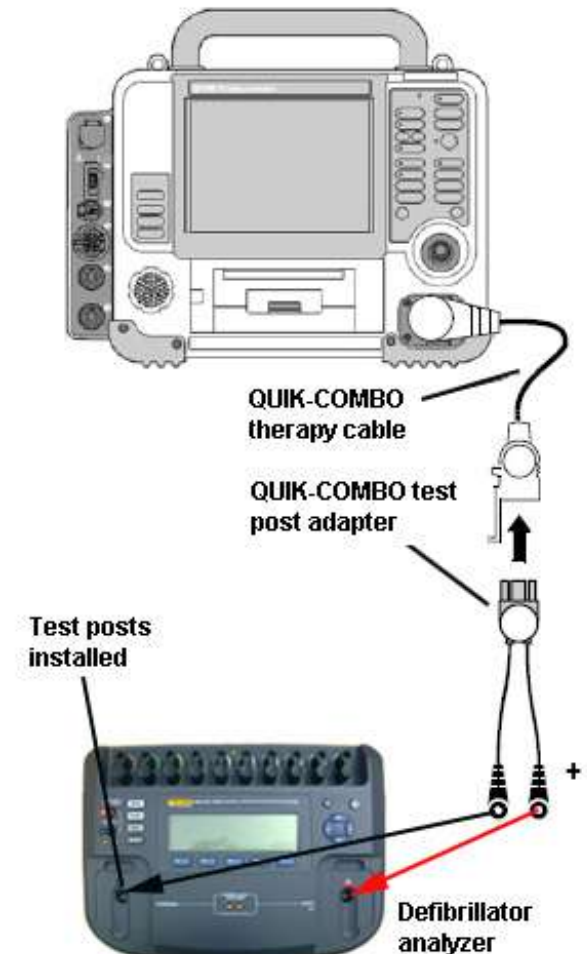

- ◆ To verify the defibrillator delivered energy: *(Continued) (8 steps, Page 2 of 2)*
  7. Verify that the defibrillator analyzer shows an energy level between the values specified in [Table 6.2](#).

**Table 6.2—Delivered Energy Output Levels**

Energy Level (J)	Acceptable Output (J)
2	3.0 to 1.0
10	9.1 to 10.1
100	102.25 to 97.75
200	214 to 186
360	384.9 to 334.9

8. When testing is complete, turn the device OFF and disconnect the test setup.

### TCP – Defibrillator Output Waveform Test

This test is optional and is intended to aid in troubleshooting the A13 Transfer Relay Assembly or the A15 Energy Storage Capacitor. Use fully charged batteries when performing this procedure.

◆ To test the defibrillator output waveform:

*(5 steps, Page 1 of 3)*

1. Connect the device to the defibrillator analyzer as described in [TCP – Defibrillator Energy Calibration \(p. 200\)](#).
2. Turn the device ON. Press ENERGY SELECT and select 360 J.
3. Press CHARGE. When the capacitor is fully charged (the Shock LED is blinking), press SHOCK to deliver the energy to the analyzer.

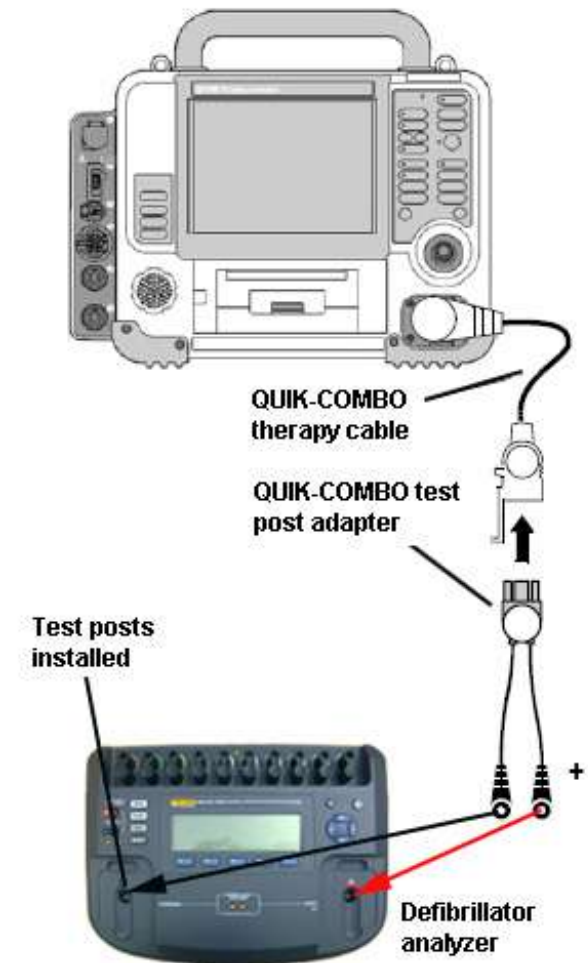

Figure 6.9—Output waveform test setup

- ◆ To test the defibrillator output waveform: (Continued)  
(5 steps, Page 2 of 3)

4. Verify that the waveform meets the specifications in Figure 6.10 and [Table 6.3 on page 205](#).

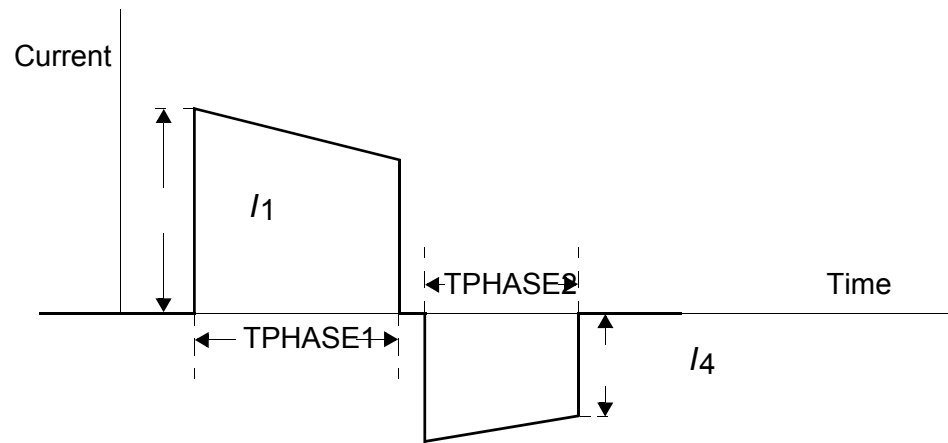

Figure 6.10—Output waveform specifications



- ◆ To test the defibrillator output waveform: (Continued)  
*(5 steps, Page 3 of 3)*

**Table 6.3—Output waveform specifications**

Phase 1 Peak Current		Phase 1 Pulse Width		Phase 2 Pulse Width	
Min	Max	Min	Max	Min	Max
35 A	42 A	6.9 ms	7.8 ms	4.5 ms	5.4 ms

5. When testing is complete, turn the device OFF and disconnect the test setup.

### TCP – Defibrillator Isolation Test

#### WARNING

**SHOCK HAZARD** Electrical energy is discharged during this procedure. Do not allow the paddle electrodes to contact any person or conductive surfaces, except as described below.

- ◆ To test defibrillator isolation after a therapy repair:
  1. Establish the Apex setup shown on the next page.
  2. Verify the defibrillator analyzer is on and set to measure ENERGY. If it is not set to ENERGY, press the ENRG softkey.
  3. Turn the LIFEPAK 15 monitor/defibrillator ON.
  4. Press ENERGY SELECT and select 360 J.
  5. Press CHARGE.
  6. When the device is fully charged (the Shock LED is blinking), press SHOCK to deliver the energy to the analyzer.
  7. Verify device displays message “Energy Delivered”.
  8. Verify the defibrillator analyzer indicates a delivered energy of less than 2 J.
  9. Turn the device OFF and disconnect the test setup.

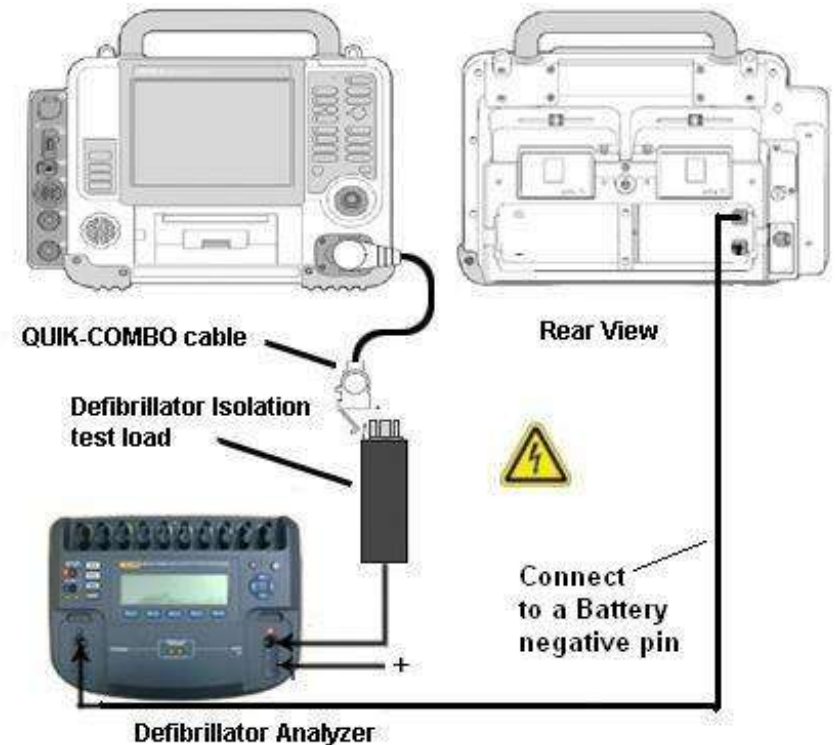

### TCP – CO2 Calibration

- ◆ To calibrate the CO2 module:  
*(12 steps, Page 1 of 3)*
  1. To complete the warm-up period, the device must be on for a total of 20 minutes before proceeding with the calibration of the CO2 module.
  2. Turn the device ON and select CO2 CAL from the Service/Calibration submenu as described in [TCP – Service/Calibration Submenu Access \(p. 194\)](#).
  3. Select CALIBRATE in the Service/Calibration/CO2 Cal submenu.

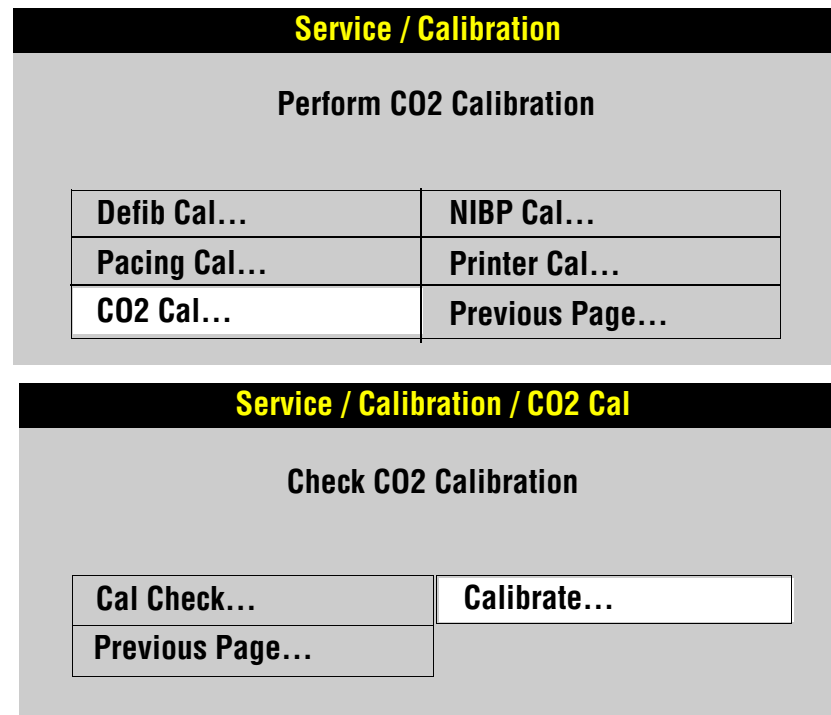

Figure 6.11—CO2 calibration submenus

- ◆ To calibrate the CO2 module: *(Continued)*  
*(12 steps, Page 2 of 3)*
  4. The overlay shown in Figure 6.12 appears.
  5. Connect the calibration gas canister to the front panel CO2 connector using a standard CO2 FilterLine and the CO2 calibration kit.
  6. Press and hold the spray nozzle to apply calibration gas.

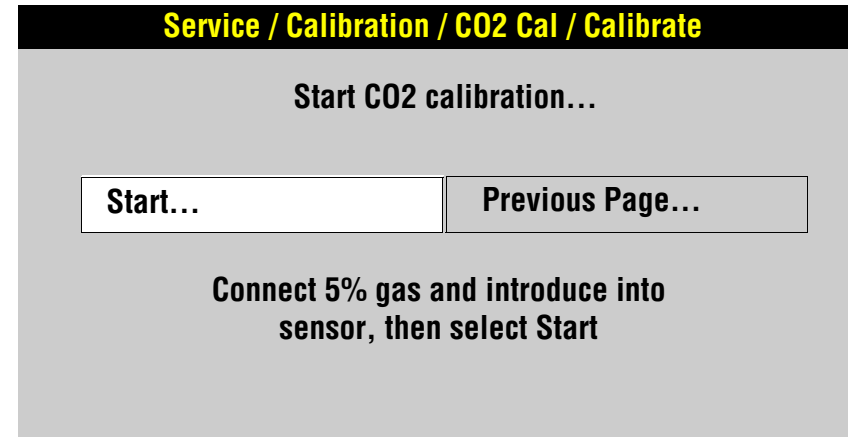

Figure 6.12—CO2 calibration overlay

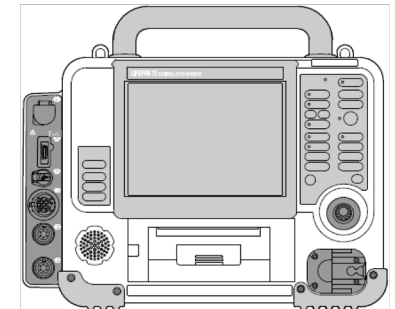
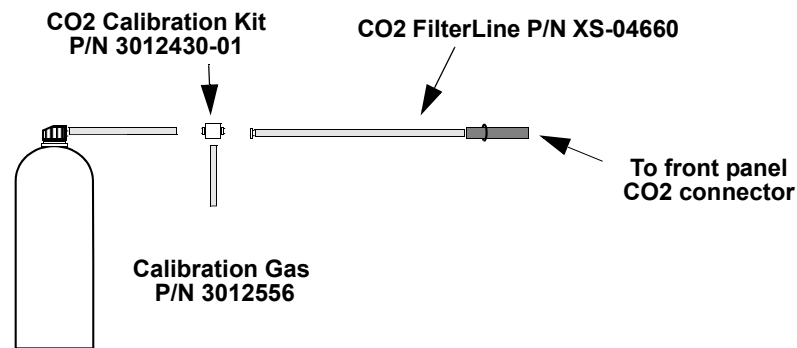

Figure 6.13—CO2 calibration connections

- ◆ To calibrate the CO2 module: *(Continued)*  
*(12 steps, Page 3 of 3)*
  7. Select START and verify that the CALIBRATION IN PROGRESS message appears.
  8. Continue pressing the spray nozzle until the DISCONNECT GAS message appears.
  9. Release the spray nozzle.
  10. Do not disconnect the FilterLine until the CALIBRATION OK message appears.
  11. Verify that the CALIBRATION OK message appears.
  12. If the CALIBRATION FAILED message appears, an error code is written into the device [Service Log \(p. 233\)](#) and the front panel Service LED illuminates.

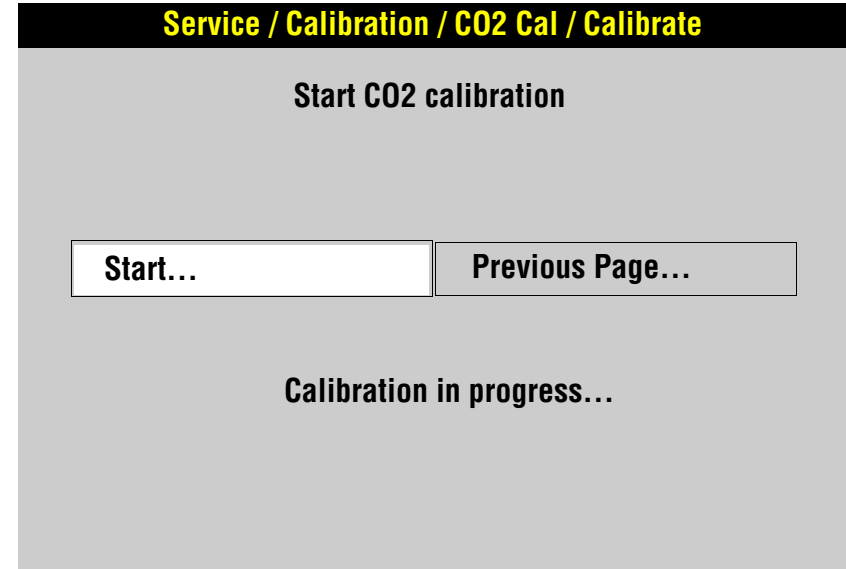

Figure 6.14—CO2 calibration start submenu

### TCP – Printer Calibration Tests

Perform the following printer calibration tests:

- [TCP – Printer Calibration at 25 mm \(p. 211\)](#)
- [TCP – Printer Calibration at 12.5 mm \(p. 212\)](#)

### TCP – Printer Calibration at 25 mm

- ◆ To perform the printer calibration procedure:
  1. Disconnect all front panel cables from the device.
  2. Display the Service/Calibration submenu as described in [TCP – Service/Calibration Submenu Access \(p. 194\)](#).
  3. Select PRINTER CAL
  4. Select START, and then press the SPEED DIAL. The printer begins printing horizontal tick marks.
  5. Notice the spacing of the printed tick marks. The correct interval between marks is 25 mm  $\pm$  1 mm (approximately 24 to 26 mm). Use the SPEED DIAL to adjust the printer speed SLOWER or FASTER.

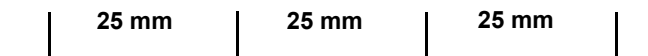

6. When the marks are spaced at 25 mm, press the SPEED DIAL to stop printing.
7. Turn the device OFF.

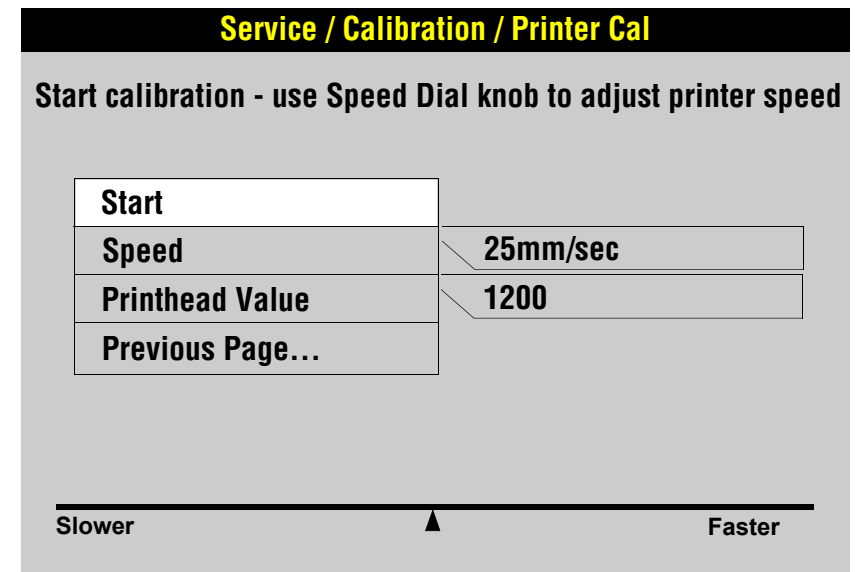
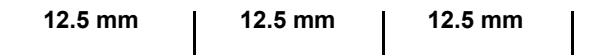

Figure 6.15—25 mm printer calibration submenu

### TCP – Printer Calibration at 12.5 mm

- ◆ To perform the printer calibration procedure:
  1. Disconnect all front panel cables from the device.
  2. Display the Service/Calibration submenu as described in [TCP – Service/Calibration Submenu Access \(p. 194\)](#).
  3. Select PRINTER CAL
  4. Select START, and then press the SPEED DIAL. The printer begins printing horizontal tick marks.
  5. Notice the spacing of the printed tick marks. The correct interval between marks is 12.5 mm  $\pm$  1 mm (approximately 12 to 13 mm). Use the SPEED DIAL to adjust the printer speed SLOWER or FASTER.



6. When the marks are spaced at 12.5 mm, press the SPEED DIAL to stop printing.
7. Turn the device OFF.

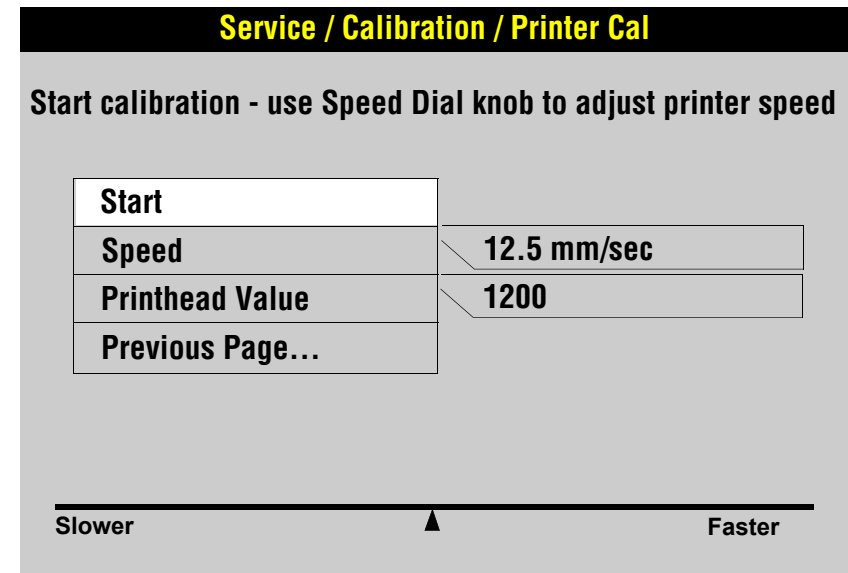

Figure 6.16—12.5 mm printer calibration submenu



### TCP – Pacer Characteristics Tests

Pacer characteristics tests include:

- [TCP – Pacer Self-Calibration \(p. 213\)](#)
- [TCP – Pacing Verification Test \(p. 214\)](#)

#### TCP – Pacer Self-Calibration

- ◆ To perform the pacer self-calibration procedure:
  1. Disconnect all front panel cables from the device.
  2. Select PACING CAL from the Service/Calibration submenu as described in [TCP – Service/Calibration Submenu Access \(p. 194\)](#).
  3. Select START to initiate the calibration routine.
  4. In less than 60 seconds, the CALIBRATION COMPLETE message appears.
  5. Turn the device OFF.
  6. Continue with the [TCP – Pacing Verification Test \(p. 214\)](#).

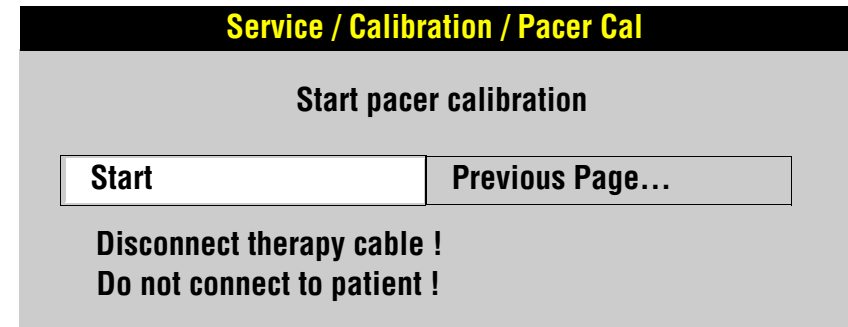

Figure 6.17—Pacer self-calibration submenu

### TCP – Pacing Verification Test

Perform the pacing verification test for currents at 10 mA, 50 mA, 100 mA, and 150 mA.

#### WARNING

**SHOCK HAZARD** Avoid contact with the energy meter. Potentially dangerous voltages will be present on energy meter electrode plates/posts.

- ◆ To verify the pacer current levels:

*(8 steps, Page 1 of 2)*

1. Connect the LIFEPAK 15 monitor/defibrillator to the Impulse 7000DP. Make sure the QUIK-COMBO (+) terminal is connected to apex (+).
2. Set the Impulse 7000DP as Input Jacks to DEFIB, Brand to MEDTRONIC, and Load to 50 ohm.
3. Turn the LIFEPAK 15 monitor/defibrillator ON.
4. Press PACER to activate pacing.
5. Set pacer rate on the LIFEPAK 15 monitor/defibrillator at 60 PPM.
6. Press CURRENT, and then use the SPEED DIAL to select the current being tested (test for 10 mA, 50 mA, 100 mA, and 150 mA).
7. Verify the measured pacer current is between the values specified in [Table 6.4](#).

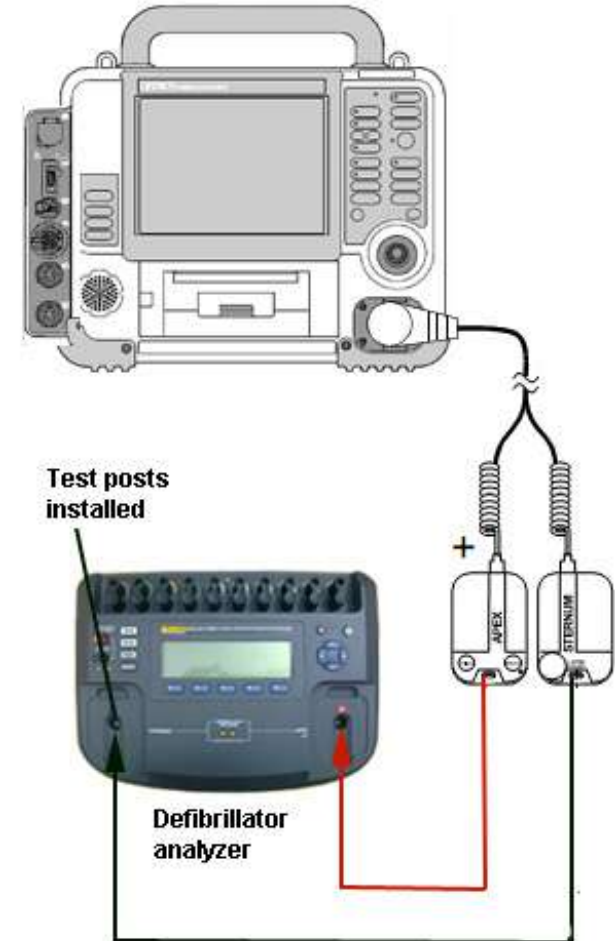

Figure 6.18—Pacing verification setup

- ◆ To verify the pacer current levels: *(Continued)*  
*(8 steps, Page 2 of 2)*

**Table 6.4—Pacer current levels**

Set Current (mA)	Output (mA)
10	5.2 to 14.8
50	45.2 to 54.8
100	95.5 to 104.8
150	142.7 to 157.3

**NOTE:** Press CURRENT, as required, to maintain the CURRENT overlay on the screen.

8. When testing is complete, turn the device OFF and disconnect the test setup.

### TCP – LIFENET Device Communications Setup

**NOTE:** The LIFENET® Device Communications for CODE-STAT Reviewer setup procedure is for testing the *Bluetooth* wireless technology option on the LIFEPAK 15 monitor/defibrillator. If the Bluetooth wireless technology option is not installed, ignore this procedure.

**NOTE:** It is assumed that the computer is using Microsoft® Bluetooth Enumerator as the driver for the Bluetooth hardware.

**NOTE:** If LIFENET Device Communications for CODE-STAT Reviewer is being used for the first time, you need to set up communication ports on your computer.

◆ To set up Bluetooth communication ports on your computer:

1. Right-click the Bluetooth icon on the computer's taskbar (lower right location).
2. Select OPEN BLUETOOTH SETTINGS.
3. Select the COM PORTS tab.
4. Add an incoming COM port on the COM Ports tab and click OK.
5. Write down the COM port name for use in the next section.

◆ To set up the COM port to operate with CODE-STAT Reviewer:

1. Open the CODE-STAT Reviewer application on your computer, and select the DEMO database.
2. Enter “physio” for the user ID and “control” for the password (case-sensitive).
3. Select UTILITIES, and then select SYSTEM CONFIGURATION.
4. Select the DEVICE DATA RECEPTION tab in the LIFENET System Configuration dialog box.
5. Click MODIFY at the bottom of the Communication Ports section.
6. In the Available window on the left side of the Communication Ports dialog box, select the COM port added previously on the COM Ports tab.
7. Click  to transfer the highlighted ports to the Use window on the right.

8. Click OK in the Communication Ports dialog box to return to the LIFENET System Configuration dialog box.
9. Click OK again. Your computer is now ready to receive data from a device.

**NOTE:** Do not close the CODE-STAT Reviewer application.

## Troubleshooting

This section describes error code usage, interpretation, and corrective action. It includes a separate troubleshooting chart keyed to the Performance Inspection Procedures (PIP) section and individual troubleshooting tests that require operator interpretation. Choose from the following topics:

- [Troubleshooting Chart \(p. 219\)](#)
- [Using the Service/Status Features \(p. 226\)](#)
- [Device Log \(p. 228\)](#)
- [Device Data \(p. 230\)](#)
- [Service Log \(p. 233\)](#)
- [Processing Service Log Codes \(p. 235\)](#)
- [Counters \(p. 236\)](#)
- [Clear Memory \(p. 238\)](#)
- [Service Log Code Categories \(p. 239\)](#)
- [Utility Service Codes \(p. 241\)](#)
- [User Interface Service Codes \(p. 242\)](#)
- [Data Management Service Codes \(p. 244\)](#)
- [System Monitor Service Codes \(p. 245\)](#)
- [Processor Control Service Codes \(p. 246\)](#)
- [ECG Service Codes \(p. 248\)](#)
- [Patient Parameter Service Codes \(p. 249\)](#)
- [Therapy Service Codes \(p. 250\)](#)
- [Printer Service Codes \(p. 257\)](#)
- [Power Management Service Codes \(p. 258\)](#)
- [Serial Communication Service Codes \(p. 259\)](#)
- [Corrective Action Codes \(p. 260\)](#)
- [Service LED \(p. 263\)](#)
- [Display Pixels Test \(p. 264\)](#)

### Troubleshooting Chart

**NOTE:** Corrective actions are listed in sequential order according to what is most likely to correct the observed symptom.

**Table 7.1— Corrective Actions**

Area	Observed Symptom	Suggested Corrective Action
Physical Inspection	Loose or broken hardware	Locate and tighten or replace loose items. Locate and replace broken components.
	Evidence of dirt, fluids, or foreign objects	Perform <a href="#">External Cleaning Procedure (p. 274)</a> .
	Damaged keypad or label	Possible A09 Printer Control Keypad failure. Possible A10 Main Keypad failure. Replace Bezel Label (158). Replace Product Identification Label (162). Replace Explosion/Hazard Label (164).
	Damaged battery pin(s)	Possible battery pin(s) failure.
Power On/Self Test	No power ON	Install fully charged, properly maintained batteries. Possible loose or broken battery pin(s). Possible W04 System/Interface PCB cable connection issue. Possible A03 Power PCB failure.
	Service LED remains ON	See <a href="#">Processing Service Log Codes (p. 235)</a> for assistance.
	MAINTENANCE DUE message appears	See <a href="#">Setting/Resetting the Maintenance Prompt Interval (p. 270)</a> .

**Table 7.1— Corrective Actions (Continued)**

Area	Observed Symptom	Suggested Corrective Action
LCD Display	Improper LCD response	Perform <a href="#">Display Pixels Test (p. 264)</a> . Possible A11 LCD Assembly failure. Possible A01 System PCB failure.
Keypads Test	Improper key response	Possible A09 Printer Control Keypad failure. Possible A10 Main Keypad failure. Possible A05 Interface PCB failure. Possible A01 System PCB failure.
Printer Test	Missing dots in printed “X”	Verify use of proper printer paper. Clean the printhead. Check A12 Printer Assembly; replace if necessary.
	One or more horizontal lines missing or distorted	Possible A01 System PCB failure.
	Missing or broken characters	Verify use of proper paper. Clean the printhead. Check A12 Printer Assembly; replace if necessary. Possible A01 System PCB failure.
	Improper 25 mm marker spacing	Calibrate the <a href="#">TCP – Printer Calibration at 25 mm (p. 211)</a> .
	Improper 12.5 mm marker spacing	Calibrate the <a href="#">TCP – Printer Calibration at 12.5 mm (p. 212)</a> .
	CHECK PRINTER message appears	Clean the paper sensor (see <a href="#">Paper Sensor Cleaning (p. 276)</a> ). Verify that the printer paper is correctly loaded. Check A12 Printer Assembly; replace if necessary.



**Table 7.1— Corrective Actions (Continued)**

Area	Observed Symptom	Suggested Corrective Action
Audio Test	Inaudible or garbled audio	Possible W17 Speaker Assembly failure. Possible A05 Interface PCB failure. Possible A01 System PCB failure.
Power Source Management Test		Verify instructions and retry test. (if available) Verify Aux Power adapter LED is ON and input cable is connected to device. Substitute another battery and retry test. Possible loose or broken battery pin(s). Possible A03 Power PCB failure.
QUIK-COMBO or Hard Paddles Delivered Energy Test	No energy discharge	Verify test setup and retry test. See <a href="#">Processing Service Log Codes (p. 235)</a> for assistance. Check therapy cable or hard paddles; replace if necessary. Possible W11 Therapy Connector Cable failure. Possible A04 Therapy PCB failure. Possible A22 Biphasic Module PCB failure. Possible A14 Inductive Resistor failure. Possible A15 Energy Storage Capacitor failure.
	ABNORMAL ENERGY DELIVERY message appears	Possible A13 Transfer Relay connection problem at P22. Possible A13 Transfer Relay failure. Possible A04 Therapy PCB failure.
	Delivered energy out of tolerance	Perform <a href="#">TCP – Defibrillator Energy Calibration (p. 200)</a> .

**Table 7.1— Corrective Actions (Continued)**

Area	Observed Symptom	Suggested Corrective Action
QUIK-COMBO Patient Impedance Test	Inappropriate screen message response	Verify test setup and retry test. Check therapy cable; replace if necessary. Possible W11 Therapy Connector Cable failure. Possible A04 Therapy PCB failure.
Defibrillation Isolation Test	Measured energy exceeds 2 joules	Verify test setup and retry test. Possible damaged internal high-voltage wiring. Possible internal high-voltage wire connection issue.
QUIK-COMBO or Hard Paddles Synchronous Cardioversion Test	No Sync mark	Verify test setup and retry test. Adjust ECG size. Possible A01 System PCB failure.
	Failure to transfer coincident with Sync mark	Take device out of Sync and attempt to discharge. Possible A10 Main Keypad failure. Check therapy cables or hard paddles; replace if necessary.
	Sync discharge time exceeds 60 ms	Verify test setup and retry test. Possible A01 System PCB failure.
Pacing Test	No pacer output	Verify test setup and retry test. Possible A13 Transfer Relay connection problem at P22. Possible A13 Transfer Relay failure. Possible A04 Therapy PCB failure.
User Test	Service LED illuminates, User Test fails	See <a href="#">Processing Service Log Codes (p. 235)</a> for assistance.

**Table 7.1— Corrective Actions (Continued)**

Area	Observed Symptom	Suggested Corrective Action
12-Lead ECG Tests	Inappropriate screen message response	Verify test setup and retry test. Check ECG cable; replace if necessary. Possible W07 ECG Connector Cable failure. Possible A01 System PCB failure.
	ECG gain out of tolerance	Verify test setup and retry test. Check ECG cable; replace if necessary. Possible A01 System PCB failure.
3-Lead ECG Tests 5-Wire ECG Tests	Inappropriate screen message response	Verify test setup and retry test. Check ECG cable; replace if necessary. Possible W07 ECG Connector Cable failure. Possible A01 System PCB failure.
	ECG gain out of tolerance	Verify test setup and retry test. Check ECG cable; replace if necessary. Possible A01 System PCB failure.
QUIK-COMBO ECG Tests	ECG gain out of tolerance	Verify test setup and retry test. Check therapy cable; replace if necessary. Possible A04 Therapy PCB failure. Possible A01 System PCB failure.
	ECG fast restore out of tolerance	Verify test setup and retry test. Check therapy cable; replace if necessary. Possible A04 Therapy PCB failure.

**Table 7.1— Corrective Actions (Continued)**

Area	Observed Symptom	Suggested Corrective Action
SpO2/SpCO/SpMet Features	Saturation reading missing or out of tolerance.  SpO2 displays XXX in the SpO2 region of the display with the Service LED OFF (review diagnostic log).	Verify test setup and retry test. Retry test with another test subject. Check finger sensor; replace if necessary. Possible device configuration setup error. Possible A16 SpO2 Module failure. Possible W22 SpO2 Connector Cable failure. Possible A06 OEM PCB failure.
	SpO2 displays XXX in the SpO2 region of the display with the Service LED ON	See error code 900e in <a href="#">Table 7.12 on page 249</a> for assistance.
NIBP Feature	NIBP displays XXX in the NIBP region of the display with the Service LED OFF (review diagnostic log).	Perform NIBP leakage test. Possible blockage or kink in tubing between NIBP connector and NIBP module. Possible A21 NIBP module failure.
	NIBP displays XXX in the NIBP region of the display with the Service LED ON	See error code 9119 in <a href="#">Table 7.12 on page 249</a> for assistance.
Temperature Feature	TEMP: ACCURACY OUTSIDE LIMITS message is displayed, and the temperature value is “XXX”	Temperature calibration required; verify test setup and test equipment accuracy requirements. Possible temperature adapter cable failure. Possible A01 System PCB failure.

**Table 7.1— Corrective Actions (Continued)**

Area	Observed Symptom	Suggested Corrective Action
CO2 Feature <b>Note:</b> The CO2 module can take up to 6 minutes for all internal processes to complete.	CO2 fails calibration	Verify test setup and retry test. Check to see if CO2 calibration gas canister is empty. Check FilterLine to see if it is disconnected. Check for pinched hose inside device. Possible A23 CO2 module failure.
	CO2 displays FilterLine Blockage message	Replace FilterLine. Possible occlusion or kinking of input tubing between CO2 connector and CO2 module. Possible A23 CO2 module failure.
	CO2 displays XXX in the CO2 region of the display with Service LED OFF	Replace FilterLine. Possible occlusion or kinking of tubing inside device. Possible A23 CO2 module failure.
	CO2 displays XXX in the CO2 region with Service LED ON (review diagnostic log).	Review error code 9205 in <a href="#">Table 7.12 on page 249</a> .
	CO2 filterLine installed with no indication on display that CO2 is connected	Clean the CO2 input connector with compressed air to remove loose debris. Replace FilterLine.

## Using the Service/Status Features

### Introduction

The device includes a series of service/status screens and menus that detail device data such as stored manufacturing data, recorded errors, and counters for shock and pacing operation.

### Displaying the Service/Status Submenu

- ◆ To display the Service/Status submenu:
  1. Press and hold the OPTIONS and EVENT buttons, and then turn the device ON. Continue holding until the Setup mode passcode prompt appears.
  2. Enter the passcode **5433** by rotating the SPEED DIAL to select a digit, and then pressing the SPEED DIAL to continue. After the last digit is entered, the Setup menu appears.
  3. Rotate the SPEED DIAL to select SERVICE in the Setup menu, and then press the SPEED DIAL. At the service passcode prompt, enter the passcode **5433**. The Service menu appears.

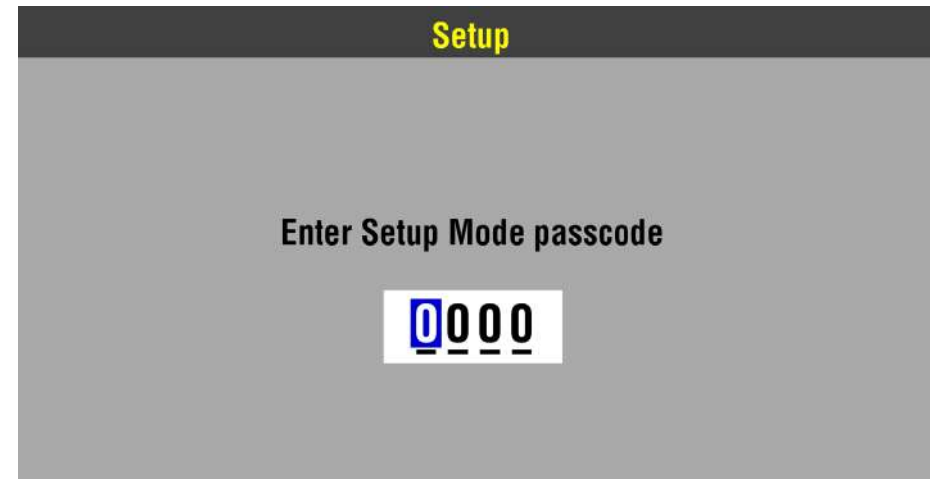

4. Rotate the SPEED DIAL to select STATUS, and then press the SPEED DIAL to display the Service/Status submenu.

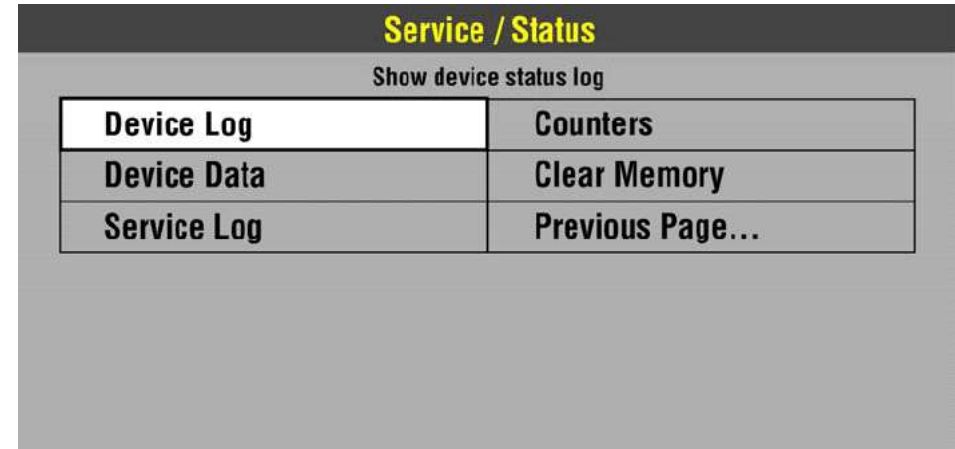

## Device Log

### Introduction

The Device Log displays accumulative device operations, such as the shock count.

### Displaying the Device Log

- ◆ To display the Device Log:
  1. Display the Service/Status submenu ([Displaying the Service/Status Submenu \(p. 226\)](#)), and then select DEVICE LOG.

Service / Status / Device Log	
Fault Messages	Yes
Power Cycle Count	385
Pacing Count	90
Shock Count	1478
Power On Time	221.5
Printer On Time	25.4
SpO2 Operating Time	67.1
CO2 Operating Time	36.85
NIBP Inflation Cycles	99

Press Speed Dial to exit



## Device Log Entries

The Device Log includes the data listed in [Table 7.2](#).

**Table 7.2—Device Log Entries**

Data	Description
Fault Messages	Records YES or NO to indicate whether there are any error codes stored in the Service Log (see <a href="#">Processing Service Log Codes (p. 235)</a> )
Power Cycle Count	Number of times the device has been turned on
Pacing Count	Total pacing pulses delivered by the device
Shock Count	Total times the device defibrillation capacitor has been charged
Power On Time	Total device power-on time
Printer On Time	Total printer running time
SpO2 Operating Time	Total SpO2 running time
CO2 Operating Time	Total CO2 running time
NIBP Inflation Cycles	Total number of inflation cycles

## Device Data

### Introduction

Device Data displays essential device characteristics, such as the serial number and part numbers.

### Displaying the Device Data

- ◆ To display Device Data:
  1. Display the Service/Status submenu ([Displaying the Service/Status Submenu \(p. 226\)](#)), and then select DEVICE DATA.

Service / Status / Device Data	
Serial Number	36260899
Manufacture Date	01 Jan 2008
Display String P/N	3208032-000 1.0.0
Audio P/N	3208031-001 1.0.1
FPGA Version	0210 0400
System SW P/N	3207410-001 0.7.4
Power SW P/N	3207365-000 1.3.3
SBC P/N	3456789-002
SpO2 S/N	3092874-000
SpO2 Version	V.1.1.1.2, V7.0.3.3
CO2 Version	V02.20, SN14886
NIBP Version	30
Bluetooth Version	3.8

Press Speed Dial to exit

### Device Data Entries

The device data includes item listed in [Table 7.3](#).

**Table 7.3—Device Data Entry**

Data	Description
Serial Number	Device serial number. If the serial number is blank, the device has lost important configuration data.
Manufacture Date	Date when the device was manufactured, specifically, when the operating software was loaded
Display String P/N	Font software part number and version, language dependent
Audio P/N	Audio software part number and version, language dependent
FPGA Version	Field-Programmable Gate Array software version
System SW P/N	Current version of the device operating software. The seven-digit part number is fixed, while the three-digit extension number changes with each software version
Power SW P/N	Power assembly software part number and version
SBC P/N	Single-Board Computer hardware part number and version
SpO2 S/N	SpO2 hardware serial number
SpO2 Version	SpO2 software version numbers
CO2 Version	CO2 software version number and serial number

Table 7.3—Device Data Entry (Continued)

Data	Description
NIBP Version	NIBP software version number
Bluetooth Version	Bluetooth software version number and date stamp

## Service Log

### Introduction

The device operating software is designed to detect and report any improper operation or device malfunction by using a system of error codes. When an internal program or process fails to execute properly, a specific four-digit hexadecimal error code is written into the device Service Log (for example, 500e), and the front panel [Service LED \(p. 263\)](#) illuminates. The illuminated Service LED is your signal to examine the Service Log and process any reported errors (see [Processing Service Log Codes \(p. 235\)](#)).

Errors rarely occur and should be investigated thoroughly by a qualified service technician before the device is placed back into active use. Always complete the [Performance Inspection Procedures \(p. 98\)](#) after encountering and clearing any error code(s).

Error codes stored in the Service Log may not necessarily indicate a permanent error. Error codes can indicate transient electromagnetic interference (EMI) or electrostatic discharge (ESD). If you suspect transient EMI or ESD as the source of an error, clear the error code(s) as described in [Clearing the Service Log \(p. 234\)](#), and then shut down and restart the device. If the error code does not recur, it may have been the result of EMI or ESD.

### Displaying the Service Log

- ◆ To display the Service Log:
  1. Display the Service/Status submenu ([Displaying the Service/Status Submenu \(p. 226\)](#)).
  2. Select SERVICE LOG. The Service/Status/Service Log overlay displays errors by date, time, error, and error extension.

### Clearing the Service Log

- ◆ To clear the Service Log:
  1. Display the Service/Status submenu ([Displaying the Service/Status Submenu \(p. 226\)](#)), and then select SERVICE LOG.
  2. Using the SPEED DIAL, select CLEAR LOG on the Service/Status/Service Log overlay.

**NOTE:** The CLEAR LOG action will record the error(s) on the 100-mm printer.
  3. Turn the device OFF or navigate to other service topics, as required.

Service / Status / Service Log							
Return to previous page							
Clear Log				Previous Page...			
01/05/08	14:25:50	0312	29520457	01/06/08	14:26:56	0314	83220007
01/05/08	14:26:56	0314	83220007	01/06/08	16:30:21	1685	41363801
01/05/08	16:30:21	1685	41363801	01/06/08	18:36:11	2164	28250457
01/05/08	16:39:03	0124	69820010	01/06/08	20:46:32	3012	75400259
01/05/08	18:25:05	3591	57220031				
01/05/08	18:36:11	2164	28250457				
01/05/08	19:11:00	0016	37939456				
01/05/08	20:25:10	0000	57958454				
01/05/08	20:44:58	0000	27915683				
01/05/08	20:45:22	2222	22224444				
01/05/08	20:46:32	3012	75400259				
01/05/08	21:00:00	0000	00000100				
01/05/08	22:25:50	2130	29520457				
01/05/08	23:10:10	1010	10101056				

## Processing Service Log Codes

When an internal program or process fails to execute properly, an error code is written into the device [Service Log \(p. 233\)](#) (for example, 500e), and the front panel Service LED (see [Service LED \(p. 263\)](#)) illuminates.

◆ To process error codes:

1. Review the error code(s) by displaying the [Service Log \(p. 233\)](#).
2. Clear the Service Log ([Clearing the Service Log \(p. 234\)](#)), and then turn the device OFF. The CLEAR LOG action will record the error(s) on the 100-mm printer.
3. Complete the [Performance Inspection Procedures \(p. 98\)](#).
  - ~ If the PIP completes successfully, the device may be returned to regular use. The error code(s) may have been related to EMI or ESD.
  - ~ If the Service LED illuminates at any time during the PIP, stop the PIP and compare your PIP failure with the [Troubleshooting Chart \(p. 219\)](#). Continue with step 4.
4. Locate the specific corrective action for a Service Log error code as follows:
  - a. Display the Service Log to view the error code(s).
  - b. Review the [Service Log Code Categories \(p. 239\)](#) for general information.
  - c. Click the appropriate link in the Initial Digit column and locate your specific error code in the table.
  - d. Click the link(s) in the Corrective Action column to view the corresponding corrective action.
  - e. Service the device based on these inputs, and then repeat the [Performance Inspection Procedures \(p. 98\)](#).
5. For persistent Service Log codes, contact your local Physio-Control service or sales representative.

## Counters

### Introduction

The device counters display the number of shocks delivered in both subtotal and running-total counts.

### Displaying the Counters

- ◆ To display the counters:
  1. Display the Service/Status submenu ([Displaying the Service/Status Submenu \(p. 226\)](#)), and then select COUNTERS.

Service / Status / Counters		
Go back to previous page		
Clear All		Previous Page...
<b>Total Shocks</b>		<b>7445</b>
<b>360J</b>	<b>707</b>	<b>2325</b>
<b>225 - 325J</b>	<b>1215</b>	<b>3399</b>
<b>0 - 200J</b>	<b>466</b>	<b>1721</b>



### Understanding the Counters

The Service/Status/Counters overlay displays the counters shown in [Table 7.4](#).

**Table 7.4—Counters**

Data	Description
Total Shocks	Running total of all the shocks ever delivered by the device. This counter cannot be reset.
360 J Shocks	The number in the box represents the number of 360-joule shocks delivered since the last reset. The number in the right column is a running total of all 360-joules shocks ever delivered by the device (cannot be reset).
225 - 325 J Shocks	The number in the box represents the number of 225-joule to 325-joule shocks delivered since the last reset. The number in the right column is a running total of all 225-joule to 325-joule shocks ever delivered by the device (cannot be reset).
1 - 200 J Shocks	The number in the box represents the number of 0-joule to 200-joule shocks delivered since the last reset. The number in the right column is a running total of all 0-joule to 200-joule shocks ever delivered by the device (cannot be reset).

### Resetting the Counters

Select CLEAR ALL on the Service/Status/Counters overlay to reset the subtotal counters in the boxes, but not the running-total counters.

## Clear Memory

### Introduction

The Clear Memory feature is used to clear the FLASH data management memory on the A01 System PCB. Specifically, you clear:

- **ECG Data** – All stored ECG data (up to 360 minutes of First-In-First-Out continuous ECG waveforms) is permanently deleted.
- **Patient Reports** – All stored patient reports are permanently deleted.

Normally you clear the data management memory after the device is placed into new or different use and the previous patient data is no longer required. You also clear the data management memory as part of certain service actions.

**NOTE:** To save important patient data before clearing the data management memory, transmit the data to a receiving device or print out individual patient data (see “Data Management” in the operating instructions).

### Clearing the Data Management Memory

- ◆ To clear the data management memory (this is permanent; there is no undo):
  1. Display the Service/Status submenu as described in [Displaying the Service/Status Submenu \(p. 226\)](#), and then select CLEAR MEMORY.
  2. A countdown timer appears to indicate the clearing process, which requires a nominal 30 seconds.

### Service Log Code Categories

Service log codes are organized into the categories shown in [Table 7.5](#), in four-digit hexadecimal format.

**Table 7.5—Error Code Categories**

Initial Digit	Category	Detail Table	Associated PCBs and Assemblies
0xxx	UT	<a href="#">Utility Service Codes (p. 241)</a>	A01 System
1xxx	UI	<a href="#">User Interface Service Codes (p. 242)</a>	A01 System, A04 Therapy, A05 Interface, A09 Printer Control Keypad, A10 Main Keypad
3xxx	DM	<a href="#">Data Management Service Codes (p. 244)</a>	A01 System
4xxx	SM	<a href="#">System Monitor Service Codes (p. 245)</a>	A01 System, A04 Therapy
5xxx	PC	<a href="#">Processor Control Service Codes (p. 246)</a>	A01 System
6xxx	ECG	<a href="#">ECG Service Codes (p. 248)</a>	A01 System
9xxx	PPxx	<a href="#">Patient Parameter Service Codes (p. 249)</a>	A01 System, A06 OEM PCB, A16 SpO2 Module, A21 NIBP Module, A23 CO2 Module
axxx	TH, DE, PA	<a href="#">Therapy Service Codes (p. 250)</a>	A01 System, A03 Power, A04 Therapy, A15 Energy Storage Capacitor, A22 Biphasic PCB
bxxx	PR	<a href="#">Printer Service Codes (p. 257)</a>	A01 System, A12 Printer Assembly

Table 7.5—Error Code Categories (Continued)

cxxx	PM	<a href="#">Power Management Service Codes (p. 258)</a>	A01 System, A03 Power
dxxx	SC	<a href="#">Serial Communication Service Codes (p. 259)</a>	A01 System

### Utility Service Codes

**Table 7.6—Initial Digit 0, Utility Service Codes (UT)**

Code	Service Code Description	Corrective Action Code
0002	UT_ERROR_FLASH_VPP (Error during flash block erase. Valid for all flash sizes.)	1
0003	UT_ERROR_FLASH_ERASE (Flash memory block erase failure. Valid for all flash sizes.)	1
0004	UT_ERROR_FLASH_8BIT_WRITE (Error during 8-bit flash write. Error status bits indicate error information. Flash not updated.)	1
0005	UT_ERROR_FLASH_16BIT_WRITE (Error during 16-bit flash write. Error status bits indicate error information. Flash not updated.)	1
0006	UT_ERROR_FLASH_PAGE_WRITE (Error during 16-bit flash write. Error status bits indicate error information. Flash not updated.)	1
0008	UT_ERROR_ADC_READ (Error during ADC read. ADC serial channel not available.)	1
000a	UT_ERROR_DAC_FAILURE (ECG DAC self-test failed. ECG DAC failure after cold boot.)	1
000c	UT_ERROR_ADC_TEST_REG (ADC Test Register Failure. ADC Test Register test failure. Failure to read the register after three tries. May also be caused by the serial channel not responding.)	1
000d	UT_ERROR_ADC_CAL_NOT_COMPLETE (ADC busy bit not clear 150 ms after calibration. ADC Self-Test Calibration test failure.)	1
000e	UT_ERROR_VP_FLASH_ID_UNKNOWN (Unknown manufacture/device ID for voice/printer flash.)	1
000f	UT_ERROR_DP_FLASH_ID_UNKNOWN (Unknown manufacture/device ID for data/program flash.)	1

### User Interface Service Codes

**Table 7.7—Initial Digit 1, User Interface Service Codes (UI)**

Code	Service Code Description	Corrective Action Code
1005	UI_ERROR_DISPLAY_SELF_TEST (Self-test failed. Upper 16 bits of status code contain the expected CRC; lower 16 bits contain the actual CRC.)	1
1006	UI_ERROR_ENERGY_FAULT (Defib charge out of 15% tolerance. Occurs only during manual mode.)	28, 10, 6, 1
1007	UI_ERROR_12LEAD_KEY_SEEN (This unit is not configured to support 12-lead, but the software saw a key closure of this key.)	11, 1
1008	UI_ERROR_ANALYZE_KEY_SEEN (This unit is not configured to support AED mode, but the software saw a key closure of this key.)	11, 1
100a	UI_ERROR_NIBP_KEY_SEEN (This unit is not configured to support NIBP, but the software saw a key closure of this key.)	11, 1
100b	UI_ERROR_CURRENTUP_KEY_SEEN (This unit is not configured to support pacing, but the software saw a key closure of this key.)	11, 1
100c	UI_ERROR_CURRENTDOWN_KEY_SEEN (This unit is not configured to support pacing, but the software saw a key closure of this key.)	11, 1
100d	UI_ERROR_RATEUP_KEY_SEEN (This unit is not configured to support pacing, but the software saw a key closure of this key.)	11, 1
100e	UI_ERROR_RATEDOWN_KEY_SEEN (This unit is not configured to support pacing, but the software saw a key closure of this key.)	11, 1
100f	UI_ERROR_PACER_KEY_SEEN (This unit is not configured to support pacing, but the software saw a key closure of this key.)	11, 1
1010	UI_ERROR_PAUSE_KEY_SEEN (This unit is not configured to support pacing, but the software saw a key closure of this key.)	11, 1
1037	UI_ERROR_UNCONFIGURED_BUTTON (Button test detected key that should not be present in current hardware configuration.)	11, 1

**Table 7.7—Initial Digit 1, User Interface Service Codes (UI) (Continued)**

Code	Service Code Description	Corrective Action Code
1038	UI_ERROR_CPR_KEY_SEEN (This unit is not configured to support AED mode, but the software saw a key closure of this key.)	11, 1
103b	UI_ERROR_MISSING_LANGUAGE (Configured language was not available.)	28, 1
1fff	UI_ERROR_EXTRA_INFORMATION (Extra error code information for an above error.)	9

### Data Management Service Codes

Table 7.8—Initial Digit 3, Data Management Service Codes (DM)

Code	Service Code Description	Corrective Action Code
3005	DM_ERROR_DATABASE_ERASE_ADJUST (Not able to write new lines for new oldest record; disables flash.)	31, 1
3006	DM_ERROR_DATABASE_ERASE_FAILED (Erase block failed; disables flash; param = block requested.)	31, 1
3007	DM_ERROR_DATABASE_ERASE_VERIFY (Verification of erased block failed; disabled flash; param = block.)	31, 1
3008	DM_ERROR_DATABASE_FLASH_ERASE (Erase database failed; disables flash; param = block # of failure.)	31, 1
3fff	DM_ERROR_EXTRA_INFORMATION (Extra error code information for an above error.)	28, 31, 1



### System Monitor Service Codes

**Table 7.9—Initial Digit 4, System Monitor Service Codes (SM)**

Code	Service Code Description	Corrective Action Code
4009	SM_ERROR_RAM_FAILURE (RAM failure during self-test. 16-bit ram test failure; param = address of failure.)	1, 6
400a	SM_ERROR_BAD_CRC (CRC in program flash bad. Program test failure; value = high 16 bits expected CRC, low 16 bits include computed CRC.)	1, 6
400b	SM_ERROR_CRC_FAILURE (Program contents failed CRC test; value = high 16 bits expected CRC, low 16 bits include computed CRC.)	1, 6
400c	SM_ERROR_VOLTAGE_LOW (ADC voltage reading low. HW voltage low; status code = high 8 bits contains ADC value, low 8 bits contains channel #.)	6, 1
400d	SM_ERROR_VOLTAGE_HIGH (ADC voltage reading high. HW voltage high; status code = high 8 bits contains ADC value, low 8 bits contains channel #.)	6, 1
4010	SM_ERROR_SERVICE_LED (Service LED failure. LED expected to be on, but it is not.)	1, 6
4011	SM_ERROR_DEFIB_SERVICE_SYNC (Failed to synchronize the defib charge after cold boot; param = time since last boot.)	6, 1
4012	SM_ERROR_FONT_VOICE_CKSUM (Invalid checksum in font/voice. Font/voice checksum error found after cold boot.)	1, 6
4013	SM_ERROR_FONT_VOICE_CRC (Invalid CRC in font/voice flash. Font/voice CRC error; status code = top 16 bits are stored CRC, low 16 bits are computed CRC.)	1, 6

### Processor Control Service Codes

**Table 7.10—Initial Digit 5, Processor Control Service Codes (PC)**

Code	Service Code Description	Corrective Action Code
5002	PC_ERROR_WATCHDOG_SHORT_FAILURE (Main watchdog short test failure. Watchdog failure; param: 0=None, 1=short, 2=long, 3=power.)	1
5003	PC_ERROR_WATCHDOG_LONG_FAILURE (Main watchdog long test failure. Watchdog failure; param: 0=None, 1=short, 2=long, 3=power.)	1
5004	PC_ERROR_WATCHDOG_UNEXPECTED (Unexpected main watchdog reset. Top 16 bits = seconds since last set. Low 16 bits = watchdog status.)	1
5005	PC_ERROR_RAM_AT_BOOT (RAM error detected during boot; param = Ram Addr of error.)	1
5006	PC_ERROR_BAD_CHECKSUM (Program contents failed Checksum test.)	1
500d	PC_ERROR_CONFIG_VERSION (System configuration version mismatch; param = value read.)	1
500e	PC_ERROR_CONFIG_CRC (NVRAM system configuration CRC bad; param = value read.)	2, 1
5011	PC_ERROR_METERS_VERSION (System meters version mismatch; param = value read.)	2, 1
5012	PC_ERROR_METERS_CRC (NVRAM system meters/counters CRC bad; param = value read.)	2, 1
5013	PC_ERROR_MFG_DATA_VERSION (Manufacturing data version mismatch.)	2, 1
5014	PC_ERROR_MFG_DATA_CRC (NVRAM manufacturing data CRC bad.)	1
5015	PC_ERROR_FORCED_RESET_FAILED (Forced watchdog reset failed. Unit failed to reset.)	1

Table 7.10—Initial Digit 5, Processor Control Service Codes (PC)

Code	Service Code Description	Corrective Action Code
5019	PC_ERROR_RTC_BAD (RTC is not running.)	2,1
501a	PC_ERROR_RTC_DRIFT (Processor and RTC time out of sync; param = drift.)	1
5032	PC_ERROR_RTC_NO_BATTERY (No Coin cell battery for the RTC.)	2,1
5033	PC_ERROR_RTC_READ (RTC read is not consistent.)	2,1

## ECG Service Codes

Table 7.11—Initial Digit 6, ECG Service Codes (ECG):

Code	Service Code Description	Corrective Action Code
600c	ECG_ERROR_DSP_VOLTAGE (DSP preamp supply voltage out of range.)	1
600d	ECG_ERROR_PREAMP_CALIBRATION (NVRAM calibration constants out of range. HW unit reported calibration error.)	20
600e	ECG_ERROR_NVRAM_FAULT (NVRAM redundant value mismatch detected. NVRAM possibly bad.)	20

### Patient Parameter Service Codes

**Table 7.12—Initial Digit 9, Patient Parameter Service Codes (PP)**

Code	Service Code Description	Corrective Action Code
900e	PPSP_ERROR_CONFIG (SpO2 module detected but not in manufacturing configuration; param: 1 = found Masimo but should not, 2 = unit not found.)	8
902d	PPSP_ERROR_MNC_CONFIG_B (SpO2 module detected but manufacturing configuration, not configured for Nellcor sensor support; param: 1 = Masimo doesn't support config B, 2 = Device doesn't support config B.)	8
9119	PPNI_ERROR_CONFIG_MISMATCH (Device with NIBP module not configured for it; param = SW version.)	8
9205	PPCO_ERROR_WRITING_TO_MODULE (CO2 module detected but not in manufacturing configuration. Unit disabled. Param = config-info.)	8
9304	PPTI_CONFLICT_IP_TEMPER_ERROR_CONFIG (IP and Temperature manufacturing configuration bits both on at the same time.)	8

### Therapy Service Codes

**Table 7.13—Initial Character a, Therapy Service Codes (TH)**

Code	Service Code Description	Corrective Action Code
a002	TH_ERROR_DEFIB_LINK_DOWN (Lost contact with defib processor. Serial communications link between the main and defib processor is not functioning. This unit can no longer administer defib therapy. Cycling power may clear the error temporarily, but unit is questionable; param = last defib message time stamp.)	10
a003	TH_ERROR_PACER_LINK_DOWN (Lost contact with pacer processor. Serial communications link between the main and pacer processor is not functioning.)	10
a004	TH_ERROR_UNEXPECTED_ENERGY (Unexpected energy in the capacitor. No charge delivered.)	10
a005	TH_ERROR_CAP_OVERCHARGED (Over-charged capacitor.)	10
a008	TH_ERROR_DEFIB_DISABLE (No communication with defib HW.)	10
a00a	TH_ERROR_DE_WRONG_ENG_SELECT (Incorrect energy selected; param = energy index.)	7, 10
a00b	TH_ERROR_SHOCK_NOT_DELIVERED (Shock not delivered.)	10
a00d	TH_ERROR_CHARGING_EXPIRED (Charging time expired.)	10
a00f	TH_ERROR_CAP_OUT_OF_RANGE (Capacitor is out of range. Calibration failure.)	10
a010	TH_ERROR_PA_RATE_OUT_OF_RANGE (Pacing rate out of tolerance; param: high-16 = pacer selected range, low-16 = pacer actual rate.)	10
a011	TH_ERROR_PA_CURRENT_OUT_OF_RANGE (Pacing current out of tolerance; param: high-16 = selected current, low-16 is actual current.)	10

**Table 7.13—Initial Character a, Therapy Service Codes (TH)**

Code	Service Code Description	Corrective Action Code
a017	TH_ERROR_DEFIB (Defib. error report)	10
a018	TH_ERROR_PACER (Pacer error report)	15
a01a	TH_ERROR_PACER_FAULT (Pacing fault condition occurred [rate(0), current(1), pulse width(2)], limit exceeded; param = pacer-fault type.)	6, 1
a01b	TH_ERROR_DEFIB_WDT_DISABLE_FAIL (Unable to turn off defib WDT; param = ASIC defib ctrl register.)	6, 1
a020	TH_ERROR_PACER_DISABLE (Pacer disabled; cannot communicate with processor.)	6, 1
a021	TH_ERROR_CAP_CHARGE_FAIL (Cap. stays zero while charging. No charge; param = defib setting.)	6, 1
a022	TH_ERROR_CORRUPT_ENERGY_SELECT (Energy select corrupt; param = main energy selection.)	6
a023	TH_ERROR_XFER_ENABLE_ON (Defib transfer-enable line high unexpected. Defib transfer-enable line was not off during startup.)	6, 1
a024	TH_ERROR_VCAP2_SATURATED (VCAP2 reading full scale all the time. Reading not processed.)	6, 1
a026	TH_ERROR_ENERGY_RESIDUE (There is still energy on the cap.)	6, 1
a027	TH_ERROR_PA_RATE_CORRUPT (Pacing rate storage corrupted; param: high-16 = rate selected, low-16 = actual rate.)	15
a028	TH_ERROR_CAL_ENERGY_FAIL (Calibrated voltage is out of range; param: high-16 = table index, low-16 = voltage count.)	6, 1
a029	TH_ERROR_BTE_FAIL (Error condition with BTE board; param: high-16 bits = fault type, low-16 bits = cedar state.)	17, 1
a02b	TH_ERROR_DEFIB_CONFIG (Conflicting defib type. Cold boot if test bit set; otherwise, disable biphasic; param = test-bit setting.)	28
a02c	TH_ERROR_DUMP_LINE_FAIL (One of dump lines failed; param = test ID.)	19

**Table 7.13—Initial Character a, Therapy Service Codes (TH)**

Code	Service Code Description	Corrective Action Code
a02d	TH_ERROR_WRONG_DEFIB_TYPE (Wrong Defib. type for software.)	28, 11
a02e	TH_ERROR_ADC_READ (ADC read failure when getting cap charge.)	28
a101	DE_ERROR_LONG_WDT (Long watchdog test failed or watchdog did not reset in time.)	7, 10
a102	DE_ERROR_SHORT_WDT (Short watchdog test failed.)	10
a103	DE_ERROR_SCI_RCV (Serial port receiver error.)	10
a104	DE_ERROR_XFER_KEY (Defib HW error.)	10
a106	DE_ERROR_ENERGY_OUT_OF_BOUND (VCAP-1 over/under charge.)	28, 10
a107	DE_ERROR_HP_ENG_SELECT (Cannot determine the rotary setting.)	10
a109	DE_ERROR_CAL_CRC (Calibration Table CRC error.)	10
a10b	DE_ERROR_CHG_TIME (Takes too long to reach charge.)	10
a10c	DE_ERROR_CHG_ENABLE (CHG_EN1 is stuck high.)	11, 10
a10d	DE_ERROR_DUMP_ENERGY (Defib HW error.)	10
a10e	DE_ERROR_RCV (Defib HW error.)	10
a111	DE_ERROR_ENERGY_NOT_ZERO (Unexpected energy while biphasic is in high-pot test.)	10
a112	DE_ERROR_TEST_XFER_ENABLE (Problem with transfer; turn on at main.)	10



**Table 7.13—Initial Character a, Therapy Service Codes (TH)**

Code	Service Code Description	Corrective Action Code
a113	DE_ERROR_TEST_XFER_ENGAGE (Error reading the transfer engage feedback.)	10
a114	DE_ERROR_TEST_DUMP_RELAY (Biphasic error.)	10
a115	DE_ERROR_TEST_ADC (Defib HW error.)	10
a116	DE_ERROR_TEST_DAC (Defib HW error.)	10
a117	DE_ERROR_TEST_HARDWARE (Defib HW error.)	10
a118	DE_ERROR_TEST_RAM (Defib HW error.)	10
a119	DE_ERROR_TEST_ROM (Defib HW error.)	10
a11a	DE_ERROR_TEST_CPU (Defib HW error.)	10
a11d	DE_ERROR_XFER_TIMEOUT (Defib HW error.)	10
a11e	DE_ERROR_BUTTONS_UP (Defib HW error.)	10
a11f	DE_ERROR_SYNC_INTERRUPT (Defib HW error.)	10
a120	DE_ERROR_SELF_TEST_INCOMPLETE (Defib HW error.)	10
a123	DE_ERROR_CAL_RCV_CRC (CRC failed for new calibration data.)	10
a124	DE_ERROR_CAL_NVM_CRC (Cannot write energy table to EEPROM.)	10
a125	DE_ERROR_DAC_WRITE (Byte could not be written to the DAC through the SPI interface.)	10

**Table 7.13—Initial Character a, Therapy Service Codes (TH)**

Code	Service Code Description	Corrective Action Code
a126	DE_ERROR_ADC_READ (Cannot read from ADC.)	10
a127	DE_ERROR_TEST_MODE (Must be idle to switch to test mode.)	10
a129	DE_ERROR_XFER_CABLE (Defib HW error.)	10
a12a	DE_ERROR_XFER_PADDLE (Defib HW error.)	10
a12c	DE_ERROR_CHG_INHIBIT (Defib HW error.)	10
a12d	DE_ERROR_CHG_ENABLE_FAIL (Charge enable feedback indicates not charging.)	10
a12e	DE_ERROR_BTE_FAULT (Cedar BTE Fault Line State.)	17
a12f	DE_ERROR_BTE_FAULT_CLEARED (Cedar BTE Fault Line State.)	17
a130	DE_ERROR_BTE_RESET (Defib HW error.)	17
a131	DE_ERROR_NO_BTE_HW (Biphasic HW not found.)	17
a132	DE_ERROR_NO_BTE_XFER (Defib HW error.)	17
a133	DE_ERROR_BTE_CEDAR_DRV_HI (A/D high bit sticky.)	17
a201	PA_ERROR_LONG_WDT (Long watchdog timer test failed.)	15
a202	PA_ERROR_SHORT_WDT (Short watchdog timer test failed.)	15
a203	PA_ERROR_SCI_RCV (SCI received overrun, framing or parity. Unit used near high EMI causing these issues.)	15

**Table 7.13—Initial Character a, Therapy Service Codes (TH)**

Code	Service Code Description	Corrective Action Code
a204	PA_ERROR_2MS_OVERRUN (2 ms ECG sampling overrun.)	15
a208	PA_ERROR_MSG_RESYNC (Received message incomplete.)	15
a209	PA_ERROR_MSG_SIZE (Received msg size error/input buff full.)	15
a20d	PA_ERROR_PACE_OVERRUN (Pacing pulse process overrun. Set current to zero.)	15
a20e	PA_ERROR_PULSE_WIDTH (Pacing pulse too long.)	15
a20f	PA_ERROR_A2D_INT (Internal A/D conversion timeout. Set current to zero.)	15
a210	PA_ERROR_A2D_EX (External A/D conversion timeout. Current set to zero.)	15
a211	PA_ERROR_SPI (SPI transfer timeout. Current set to zero.)	15
a212	PA_ERROR_RAM_TEST (RAM test failed. Reset Pacer Processor.)	15
a213	PA_ERROR_ROM_TEST (ROM CRC test failed.)	15
a214	PA_ERROR_CPU_TEST (Stack overrun occurred.)	15
a215	PA_ERROR_STACK_CHECK (Isolated +5 V ref. out of range.)	15
a216	PA_ERROR_V_ISO_MON (HV present when not pacing.)	15
a217	PA_ERROR_V_12V_MON (+12 V voltage out of range.)	15
a218	PA_ERROR_V_HVIS_SENSE (HV present when not pacing.)	15

**Table 7.13—Initial Character a, Therapy Service Codes (TH)**

Code	Service Code Description	Corrective Action Code
a219	PA_ERROR_V_HVIS (HVIS voltage out of range.)	15
a21a	PA_ERROR_CAL_CURRENT (Current calibration failed.)	15
a21b	PA_ERROR_CAL_Z_300 (Impedance 300 calibration failed.)	15
a21c	PA_ERROR_CAL_CURRENT_CRC (Current cal table corrupt.)	15
a21d	PA_ERROR_CAL_IMPEDANCE_CRC (Impedance cal values corrupt.)	15
a21e	PA_ERROR_CAL_Z_0 (Impedance 0 calibration failed.)	15
a21f	PA_ERROR_PACE_I (Current present when not pacing.)	15
a220	PA_ERROR_NO_HVIS_SENSE (No HV present when pacing.)	15
a221	PA_ERROR_EXT_A2D_TEST (External A/D test register reset failed.)	15
a222	PA_ERROR_NO_CAL_HVIS_SENSE (No HV present before current cal.)	15
a223	PA_ERROR_NO_Q4_SENSE (No Q4 sense when not pacing [Q4 shorted].)	15
a224	PA_ERROR_Q4_SENSE (Q4 sense present when pacing [CR25 open].)	15

## Printer Service Codes

Table 7.14—Initial Character b, Printer Service Codes (PR)

Code	Service Code Description	Corrective Action Code
b001	PR_ERROR_TEMP_TOO_LOW (Printhead ADC reading too low; param = ADC value. May be associated with UT_ERROR_DAC_FAILURE and UT_ERROR_ADC_READ.)	13, 28
b002	PR_ERROR_TEMP_TOO_HIGH (Printhead ADC reading too high; param = ADC value. May be associated with UT_ERROR_DAC_FAILURE and UT_ERROR_ADC_READ.)	13, 28
b003	PR_ERROR_SELF_TEST_FAIL (Invalid CRC read from HW; param = ADC value.)	13, 28
b004	PR_ERROR_WRONG_PRINTER_TYPE (Saw incorrect printer for config; 50/100 mismatch.)	13, 28

## Power Management Service Codes

Table 7.15—Initial Character c, Power Management Service Codes (PM)

Code	Service Code Description	Corrective Action Code
c008	PM_ERROR_LOST_COMMS (Lost communications with power PCB.)	7, 1
c009	PM_ERROR_CLOCK_FAILURE (Power PCB is running on its internal oscillator block because it detected an external clock failure.)	1, 7

### Serial Communication Service Codes

Table 7.16—Initial Character d, Serial Communication Service Codes (SC)

Code	Service Code Description	Corrective Action Code
d003	SC_ERROR_SCI_FRAME (SCI frame error.)	1
d004	SC_ERROR_SCI_PARITY (SCI parity error.)	1
d005	SC_ERROR_READ_FULL (SCI read buffer full.)	1
d006	SC_ERROR_SCI_INITIALIZE (SCI did not initialize.)	1
d00d	SC_ERROR_SCI_MSGQ_ERROR (Queue Full. Param indicates the message type: 0=pacer, 1=Defib, 2=pwr.)	28, 1

### Corrective Action Codes

Corrective action codes are referenced in the error code tables under [Service Log Code Categories \(p. 239\)](#). If more than one action is listed under Description, perform them in the order indicated.

**Table 7.17—Corrective Action Codes**

Corrective Action Code	Description
1	System Communications or System Processing Error: a. Verify that the appropriate connecting cables and wire harnesses are functional. b. Possible EMI or ESD interference. Clear Service Log and then conduct <a href="#">Performance Inspection Procedures (p. 98)</a> . c. Possible A01 System PCB failure.
2	Real time clock failure: Possible nonvolatile RAM failure on coin battery power on A01 System PCB.
6	Therapy Processor Error: a. Verify that the appropriate connecting cables and wire harnesses are functional. b. Possible A04 Therapy PCB failure.
7	Power Processor Error: a. Verify that the appropriate connecting cables and wire harnesses are functional. b. Possible A03 Power PCB failure.
10	Defibrillator out of calibration: a. Complete the <a href="#">TCP – Defibrillator Energy Calibration (p. 200)</a> procedure, and then conduct <a href="#">Performance Inspection Procedures (p. 98)</a> . b. Verify that the appropriate connecting cables and wire harnesses are functional. c. Possible A04 Therapy PCB failure. d. Possible A22 Biphasic PCB/A14 Inductive Resistor failure.



**Table 7.17—Corrective Action Codes (Continued)**

Corrective Action Code	Description
11	Configuration or keypad Error: a. Check device configuration settings against installed hardware. b. Possible A09 Printer Control Keypad or A10 Main Keypad failure. c. Verify that the appropriate connecting cables and wire harnesses are functional.
8	Device manufacturing configuration bit is not set (Physio-Control service required). Possible nonvolatile RAM failure on A01 System PCB.
13	Printer Error: a. Possible A12 Printer Assembly failure. b. Verify that the appropriate connecting cables and wire harnesses are functional.
15	Pacer out of calibration: a. Complete the <a href="#">TCP – Pacer Self-Calibration (p. 213)</a> procedure, and then conduct <a href="#">Performance Inspection Procedures (p. 98)</a> . b. Verify that the appropriate connecting cables and wire harnesses are functional. c. Possible A04 Therapy PCB failure.
17	Biphasic fault or unknown energy: a. Verify that the appropriate connecting cables and wire harnesses are functional. b. Possible A22 Biphasic PCB failure. c. Possible A04 Therapy PCB failure.

Table 7.17—Corrective Action Codes (Continued)

Corrective Action Code	Description
19	Dump error code (a02c): a. Verify that the appropriate connecting cables and wire harnesses are functional. b. Possible A04 Therapy PCB failure. c. Possible A22 Biphasic PCB failure. d. Possible A01 System PCB failure.
20	ECG error: a. Verify that the appropriate connecting cables and wire harnesses are functional. b. Possible A01 System PCB failure.
28	The current device software version is recommended, contact Physio-Control Field Service (see <a href="#">Service Information (p. 19)</a> ).
31	Clear Data Management memory.

## Service LED

### What the Service LED Does

The Service LED illuminates when an error code is written to the Service Log. Always examine such instances using the instructions in [Processing Service Log Codes \(p. 235\)](#).

### What the Service LED Does Not Do

The Service LED is not used to indicate the presence of errors in the Service Log, rather it is used to indicate when errors are written to the Service Log. For example, if the Service LED illuminates when you turn on the device, it indicates the presence of errors in the Service Log. If you turn the device OFF and then ON again and the Service LED does not illuminate, it does not indicate that there are no error codes in the Service Log. You still must review the Service Log and resolve what was written there in the first instance.

### Display Pixels Test

- ◆ To troubleshoot LCD display viewing issues:
  1. Enter the Service mode (see [Entering Service Mode \(p. 95\)](#)) and select TESTS.
  2. Select PIXELS in the Service/Tests submenu. The LCD display changes to a uniformly lit screen of medium contrast.
  3. Carefully examine the screen for any anomalies. Rotate the SPEED DIAL to examine each color display on the screen.
  4. Press SPEED DIAL to end the test and return to the Service/Tests submenu.
  5. Turn the device OFF or navigate to other service options, as required.

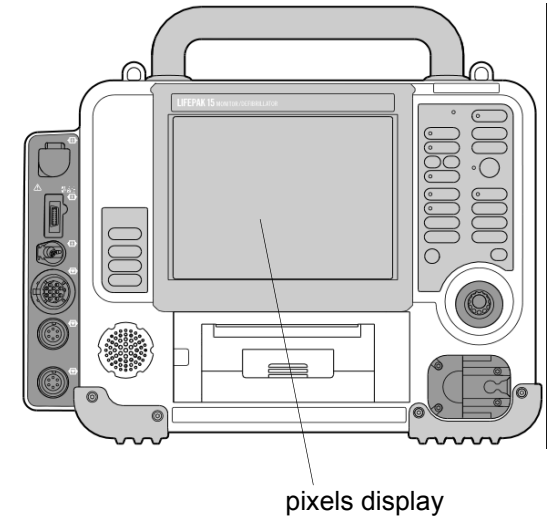

## Preventive Maintenance

Periodic maintenance, inspection, and testing of the device help prevent and detect possible electrical and mechanical problems.

For information about battery charging, conditioning, and battery-related topics, see [Battery Maintenance \(p. 278\)](#). The information in this section includes the following:

- [Device Self Tests \(p. 266\)](#)
- [Device User Test \(p. 267\)](#)
- [Preventive Maintenance and Testing Schedule \(p. 268\)](#)
- [Scheduled Replacement Items \(p. 269\)](#)
- [Setting/Resetting the Maintenance Prompt Interval \(p. 270\)](#)
- [Device Useful Life \(p. 271\)](#)
- [Support Policy \(p. 272\)](#)
- [Cleaning \(p. 273\)](#)
- [Environmental Conditions \(p. 275\)](#)
- [A12 Printer Maintenance \(p. 276\)](#)

## Device Self Tests

### Device Self Test

When you turn on the LIFEPAK 15 monitor/defibrillator, a series of self-tests occur. If errors are detected, the [Service LED \(p. 263\)](#) illuminates. Self-testing does not occur only when the device is turned ON; rather, it is continuous, repeating over and over again while the device is on.

### Device Auto Test

The device performs an automatic self-test daily at 03:00 (3:00 A.M.), if not in use. During the automatic self-test, the defibrillator turns itself on (ON LED illuminates) briefly and completes the following tasks:

- Performs a self-test
- Stores the self-test results in the test log and prints report
- Turns itself off

The V2 device can also automatically transmit self-test results. LIFENET asset management is required to view transmitted auto test data. For information about enabling transmission of test results, see the *LIFEPAK 15 Monitor/Defibrillator Setup Options* guide provided with the V2 device.

If the defibrillator detects a problem during an auto test, it annotates the fault condition on the printed test report.

The automatic self-test is not performed if the defibrillator is already turned on at 03:00 or if batteries are not installed. If the defibrillator is manually turned on while a self-test is in progress, the self-test is halted and the defibrillator turns on normally.

## Device User Test

### Device User test

When you use the SPEED DIAL to navigate to Options/User Test, the device waits until the next self-test cycle is complete. The user test performs the following tasks:

- Performs a self-test
- Charges the defibrillation capacitor to 10 joules, then dumps the charge
- Stores the test results in the test log
- Displays User Test results and prints report

If this operation does not pass, the Service LED illuminates and an error is written to the [Service Log \(p. 233\)](#).

### Preventive Maintenance and Testing Schedule

Table 8.1 shows the schedule for preventive maintenance activities (see the *Operator's Checklist* in the operating instructions for additional items). For items that should be replaced at regular intervals, see [Scheduled Replacement Items \(p. 269\)](#).

**Table 8.1—Schedule for Maintenance and Testing**

Activity	Daily	As Needed	12 Months
<a href="#">Performance Inspection Procedures (p. 98)</a>		•	•
<a href="#">Test and Calibration Procedures (TCP) (p. 188)</a>		•	
<a href="#">Exterior Physical Inspection (p. 111)</a>	•		•
<a href="#">External Cleaning Procedure (p. 274)</a>		•	•



### Scheduled Replacement Items

The following items should be replaced at regular intervals because of their finite life span:

- **Disposable Electrodes**—Replace electrodes by the  “Use by” date.
- **ECG cable (3-lead/5-wire/12-lead)**—Replace to ensure the continued performance of this cable.
- **Lithium-ion battery pak** — Replace to ensure maximum operating time of the device.
- **Coin battery** — Replace to ensure the device will not lose battery power for the real-time clock.

**NOTE:** Contact your Physio-Control Service Representative for assistance when coin battery replacement is required.

[Table 8.2](#) shows the schedule for replacement items.

**Table 8.2—Replacement Schedule**

Replacement Item	Frequency
Replace ECG cable	2 years
Replace battery pak	2 years
Replace coin (clock) battery	5 years

### Setting/Resetting the Maintenance Prompt Interval

The MAINTENANCE DUE message can be set up to appear at selected intervals (3, 6, or 12 months). When this time interval is reached, the message appears continuously for 10 minutes each time the device is turned on.

After completing a scheduled maintenance, reset the maintenance prompt interval timer to clear the MAINTENANCE DUE message and begin the count for the next scheduled maintenance.

- ◆ To change the scheduled maintenance interval:
  1. Enter Service mode as described in [Entering Service Mode \(p. 95\)](#).
  2. Select MAINT PROMPT to display the Service/Maint Prompt submenu, which shows the NEXT PROMPT date for scheduled maintenance.
  3. Select INTERVAL.
  4. Select the desired interval. The factory default setting is OFF.
- ◆ To clear the MAINTENANCE DUE message after scheduled maintenance is completed:
  1. Select RESET on the Service/Maint Prompt submenu. The NEXT PROMPT date is revised to the new scheduled maintenance date.
  2. Turn the device OFF.

## Device Useful Life

During product development, the LIFEPAK 15 monitor/defibrillator and subassemblies are subjected to rigorous life-testing. The routine testing and maintenance program recommended in this service manual will help provide reliable device operation for many years. However, both rapid technological changes and the availability of replacement parts limit the useful life of all modern medical devices. The American Hospital Association suggests a five-year useful life expectancy for defibrillators (*Estimated Useful Lives of Depreciable Hospital Assets, Revised 1993 Edition*). Similarly, the US Army lists an eight-year life expectancy for defibrillators (technical bulletin: *Maintenance Expenditure Limits for Medical Materiel, TB MED 7 Revision 8 October 1993*).

### Support Policy

Physio-Control provides full technical support and replacement parts for a period of eight years from the date of shipment from our manufacturing facility. After this eight-year period, Physio-Control provides technical support and replacement parts on an as-available basis.

## Cleaning

### Tools and Materials

The tools and materials needed to perform an external cleaning of the LIFEPAK 15 monitor/defibrillator are listed in [Table 8.3](#).

**Table 8.3—Cleaning Tools and Materials**

Product	Description
Static-discharge-protected work area	Grounded conductive surface and wrist strap
Isopropyl alcohol	
Soap and water	
Quaternary ammonium compounds	
Peroxide (peracetic acid) solutions	
Cotton swabs	
Vacuum cleaner	
Soft-bristle brush	Nonmetallic
Cloth	Clean and lint-free
Compressed air	Clean and dry (60 psi, max.)

### External Cleaning Procedure

#### WARNING

**SHOCK OR FIRE HAZARD** Do not immerse or soak any portion of this device in water or any other fluid. Avoid spilling any fluid on the device or accessories.

#### CAUTION

**POSSIBLE CASE DAMAGE** Do not clean any part of this device or accessories with bleach, bleach dilution, or phenolic compounds. Do not use abrasive or flammable cleaning agents. Do not attempt to sterilize this device or any accessories unless otherwise specified in the accessory operating instructions.

Clean the exterior of the device by wiping the surface with any of the following solutions:

- Soap and water
- Quaternary ammonium compounds
- Isopropyl alcohol
- Peroxide (peracetic acid) solutions

## Environmental Conditions

### Operating Conditions

Maintain the following operating temperatures when the device is in use:

- 32° to 113°F (0° to 45°C)
- -4°F (-20°C) for 1 hour after storage at room temperature
- 140°F (60°C) for 1 hour after storage at room temperature

Maintain the following relative humidity when the device is in use:

- 5 to 95%, non-condensing
- NIBP: 15 to 95%, non-condensing

### Storage Conditions

When the device is not in use, store as follows:

- -4° to 149°F (-20° to 65°C), except therapy electrodes and batteries

Maintain the following relative humidity when the device is in storage:

- 10 to 95%, non-condensing

## A12 Printer Maintenance

### Print Roller Cleaning

To remove paper debris and other residue from the print roller, soak a cotton swab with alcohol and wipe across the roller surface.

### Printhead Cleaning

Clean the printhead after using approximately 100 rolls of chart paper, or more often if needed. Use a cotton swab soaked in clean isopropyl alcohol.

1. Turn the device OFF. Locate the printhead between the two brushes on the upper half of the printer.
2. Wipe the surface of the printhead clean with the alcohol-soaked cotton swab, allowing only the cotton tip of the swab to contact the printhead.

### Paper Sensor Cleaning

The paper sensor also requires periodic cleaning to prevent paper debris from blocking the infrared signals that reflect off the paper during normal operation.



Clean the sensor whenever the printhead is cleaned. Use a clean cotton swab soaked in clean isopropyl alcohol. Gently wipe the surface of the paper sensor with the tip of the swab.

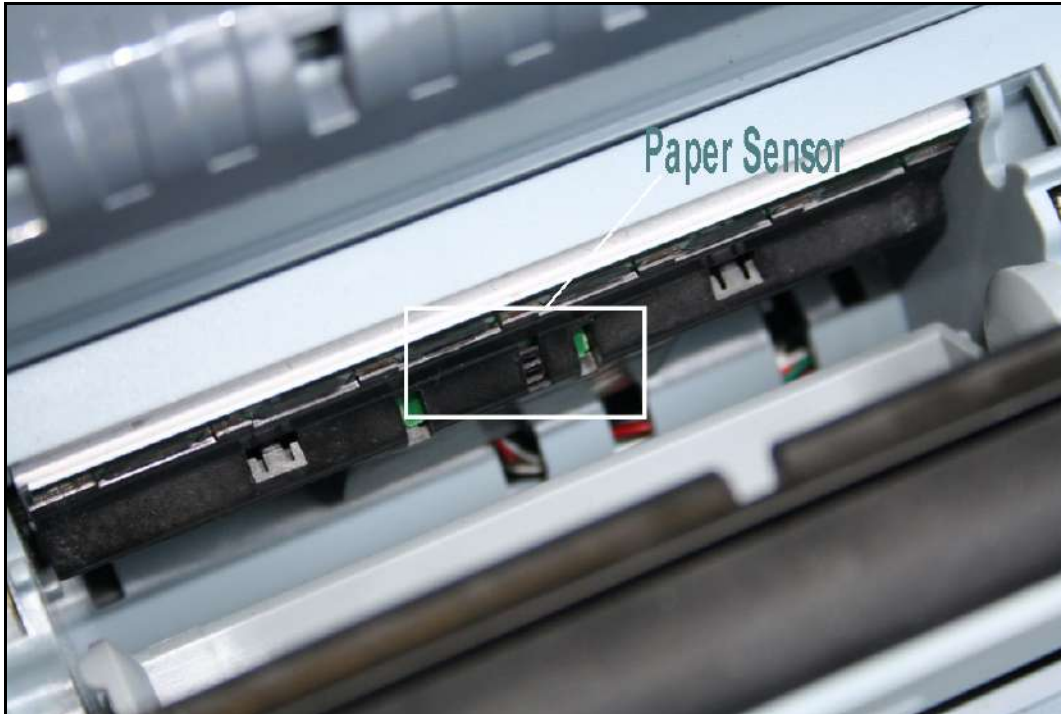

Figure 8.1—Paper sensor

## Battery Maintenance

Follow the guidelines described in this section to help maximize battery life and performance.

- [Battery General Characteristics \(p. 279\)](#)
- [Battery Status Indicators \(p. 280\)](#)
- [Battery Fuel Gauge \(p. 281\)](#)
- [Battery Performance Characteristics \(p. 283\)](#)
- [Charging the Batteries Using the Station or Mobile Li-ion Battery Charger \(p. 284\)](#)
- [Discarding/Recycling Batteries \(p. 285\)](#)
- [Storing Batteries \(p. 286\)](#)
- [Receiving New Batteries \(p. 287\)](#)
- [Coin Cell Battery \(p. 288\)](#)

For information about the LIFEPAK 15 monitor/defibrillator Li-ion battery chargers, see the *Station and Mobile Lithium-ion Battery Chargers Instructions for Use* (MIN 3208093), or see the *REDI-CHARGE, AC Battery Charger Instructions for Use* (MIN 3301046).

### Battery General Characteristics

#### WARNING

**POSSIBLE LOSS OF POWER DURING PATIENT CARE** Physio-Control has no information regarding the performance or effectiveness of its LIFEPAK monitor/defibrillators if other manufacturers' batteries or battery chargers are used. Using other manufacturers' batteries or battery chargers may cause the device to perform improperly and invalidate the safety agency certifications. Use only Physio-Control LIFEPAK 15 monitor/defibrillator batteries (PN 3206735) and the appropriate Physio-Control LIFEPAK 15 monitor/defibrillator battery charger.

The device is powered by two LIFEPAK 15 Lithium-ion (Li-ion) rechargeable batteries.

The battery communicates through contacts located on the bottom of the battery, allowing the exchange of information about battery type, amp hours rating, charge rate, target voltage, current, and other parameters. See "Battery Maintenance" in the operating instructions for additional information about the LIFEPAK 15 monitor/defibrillator Li-ion battery maintenance.

**NOTE:** The LIFEPAK 15 monitor/defibrillator Lithium-ion batteries, battery chargers, and power cords are not interchangeable with batteries, battery chargers, and power cords used in other LIFEPAK defibrillators.

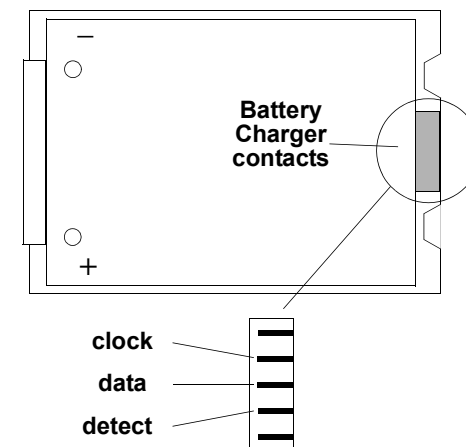

## Battery Status Indicators



### Home Screen

The Home Screen displays battery indicators that show the following information about the batteries installed in the device:



- Presence or absence of battery in battery well
- Battery in use
- Battery charge state

When two batteries are installed, the device uses the battery with the lowest level of charge first. The battery in use is indicated by a white battery number in a black box. When a battery reaches the “replace battery” state, the device automatically switches to the other battery. [Table 9.1](#) provides a description of the various battery status indicators.

**Table 9.1—Battery Status Indicator**

Indicator	Meaning	Description
	Active battery	The device is using the battery in Well 1 for power. Battery status indicators display up to four green bars. Each green bar represents approximately 25% remaining charge. For example, three green bars indicate about 75% remaining charge.
	Low battery	Battery in Well 1 is in use and is low. One yellow bar indicates 5% to 10% remaining charge.
	Very low battery	Battery in Well 1 is in use and is very low. One red flashing bar indicates 0% to 5% remaining charge. The device automatically switches to the other battery only if adequate charge is available. If both batteries show red bars, the REPLACE BATTERY voice prompt occurs.

**Table 9.1—Battery Status Indicator (Continued)**

Indicator	Meaning	Description
	Unrecognized battery	Battery in Well 2 is not in use. Battery communication failed or a non-Physio-Control battery is installed. The battery may power the device, but the level of charge is unknown and low battery messages and prompts will not occur.
	No battery installed or fault detected	No battery is installed in Well 1, or a fault was detected in the battery in Well 1 and the device will not use the battery.

When all battery capacity is exhausted, the device turns OFF. If you insert a fresh battery and repower the device in less than 30 seconds, the device retains its settings. For more information, see [Battery Performance Characteristics \(p. 283\)](#).

### Battery Fuel Gauge

The LIFEPAK 15 Li-ion battery has a pushbutton fuel gauge and the ability to communicate with the Li-ion battery charger.

The pushbutton fuel gauge provides a visual indication of battery capacity and battery condition through a series of four green LEDs. Pressing this button illuminates the LEDs in one of the following patterns:

The displayed battery fuel gauge shows four levels of stored energy as shown in the following table:

**Table 9.2—Fuel gauge indicator**

# Fuel Gauge LEDs	Absolute State of Charge (ASOC)	Messaging/Comments
4 green	75% < ASOC	None
3 green	50% < ASOC	None
2 green	25% < ASOC	None
1 green	15% < ASOC	None

Table 9.2—Fuel gauge indicator (Continued)

# Fuel Gauge LEDs	Absolute State of Charge (ASOC)	Messaging/Comments
1 yellow	$5\% < \text{ASOC}$	LOW BATTERY Charge the battery (see <a href="#">Charging the Batteries Using the Station or Mobile Li-ion Battery Charger (p. 284)</a> )
1 flashing red	$\text{ASOC} \leq 5\%$	REPLACE BATTERY Charge the battery (see <a href="#">Charging the Batteries Using the Station or Mobile Li-ion Battery Charger (p. 284)</a> )

### Battery Performance Characteristics

The following factors affect Li-ion battery performance:

- **Temperature**
  - ~ AC input: Charge batteries at a temperature range of 10° to 40°C (50° to 104°F).
  - ~ DC input: Charge batteries at a temperature range of 5° to 50°C (41° to 122°F) (Mobile charger only).
  - ~ Store batteries at the recommended temperature range of 20° to 25°C (68° to 77°F). Lower temperatures within the recommended range reduce the battery self-discharge rate and increase battery life.

#### CAUTION

**POSSIBLE BATTERY DAMAGE** The Li-ion battery charger will not charge batteries if the temperature is below 0°C or above 50°C.

Table 9.3 provides the performance characteristics of the LIFEPAK 15 Li-ion batteries (at 20°C).

**Table 9.3—Li-ion Battery Characteristics**

Operating Mode		Monitoring Minutes	Pacing (Minutes)	Defibrillation (360 J Discharges)
Total Capacity to Shutdown	Typical (20°C)	360	340	420
	Minimum (20°C)	340	320	400
Capacity After LOW BATTERY Message	Typical (20°C)	21	20	30
	Minimum (20°C)	12	10	6

### Charging the Batteries Using the Station or Mobile Li-ion Battery Charger

#### WARNING

##### POSSIBLE LOSS OF POWER AND DELAY OF THERAPY DURING PATIENT CARE

Using an improperly maintained battery to power a defibrillator may cause power failure without warning. Use the appropriate equipment to charge batteries.

LIFEPAK 15 monitor/defibrillator batteries are charged in the Physio-Control station or mobile Li-ion battery charger. The typical charge time for a fully depleted LIFEPAK 15 Li-ion battery is 4 hours and 15 minutes. To maximize performance and battery life, maintain an ambient temperature for the Li-ion battery charger between 20°C and 25°C (68°F and 77°F) when charging a LIFEPAK 15 Li-ion battery.

- ◆ To charge a LIFEPAK 15 Li-ion battery in the battery charger:

**NOTE:** When charging for the first time, remove the Charge Before Use label prior to placing the battery in the charger.

1. Place the battery in an open charging bay. The green LED starts blinking to indicate it is charging.
2. Remove the charged battery when the green LED stops blinking and remains illuminated, indicating that it is ready.

**NOTE:** If the red LED illuminates, remove the battery and discard/recycle (see [Discarding/Recycling Batteries \(p. 285\)](#)).

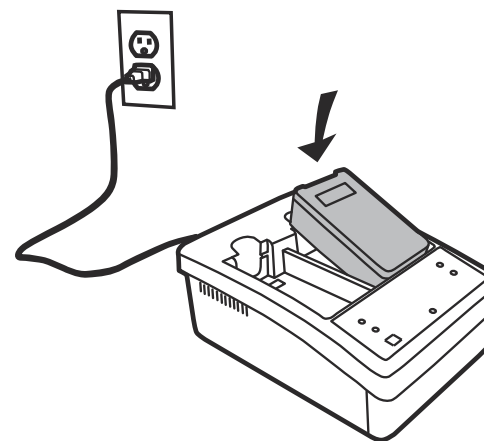



### Discarding/Recycling Batteries

A properly maintained LIFEPAK 15 Li-ion battery should have a useful life of at least two years, although internal parameters will establish useful battery life. You should discard/recycle a LIFEPAK 15 Li-ion battery under any of the following conditions:

- There is physical damage to the battery case.
- The Li-ion battery charger indicates a battery fault (solid red LED) during a charging cycle.
- The battery fuel gauge indicates two or fewer green LED bars after the battery completes a charge cycle.

Recycle batteries locally according to national, regional, and local governmental regulations. For instructions on disposing of batteries, see <http://recycling.medtronic.com>.

If recycling is not possible, contact a Physio-Control representative for information or assistance. In the U.S., call 1.800.442.1142.

To promote awareness of battery recycling, batteries are marked with one of these symbols:



## Storing Batteries

### WARNING

**POSSIBLE LOSS OF POWER DURING PATIENT CARE** Stored batteries lose charge. Failure to charge a battery before use may cause device power failure without warning. Always charge a stored battery before placing it in use.

A battery is considered to be in storage when it is not in active use.

LIFEPAK 15 Li-ion batteries require special handling procedures for storage and then placing in use.

- Storage temperatures ranges:
  - ~ Short term (<1 week): -20° to 60°C (-4° to 140°F)
  - ~ Long term (>1 week): 20° to 25°C (68° to 77°F)
- Operating and storage humidity range: 5% to 95% relative humidity, non-condensing
- Fully charge LIFEPAK 15 Li-ion batteries before storing, and at least annually while in storage.
- Do not freeze batteries. Damage to the battery may result.
- Charge stored batteries before placing in use.

### Receiving New Batteries

#### WARNING

**POSSIBLE LOSS OF POWER DURING PATIENT CARE** New batteries may not be fully charged. Failure to charge a battery before use may cause device power failure without warning. Always charge a new battery before placing it in use.

When you receive new batteries, charge each new battery prior to placing in use (see [Charging the Batteries Using the Station or Mobile Li-ion Battery Charger \(p. 284\)](#)).

### Coin Cell Battery

The coin cell battery, MIN 202305-000 (type CR2032), powers the device real-time clock and user-configured settings (custom events and ECG lead sets). The coin cell battery should be replaced every five years.

Preserve the existing Setup Options prior to replacing the coin cell battery. See details in [Setup Mode \(p. 92\)](#).

For Coin Cell Battery replacement (see [Coin Battery Replacement \(p. 482\)](#)).

## Replacement Procedures

The replacement procedures are a set of detailed instructions for disassembly, handling, and reassembly of replaceable LIFEPAK 15 monitor/defibrillator parts. Perform an interior inspection whenever the LIFEPAK 15 monitor/defibrillator case is opened for service. When disconnecting cables and wire harnesses, label the cables and connections so that they match easily during reassembly, for example, J01, J03, and so forth. See the [Interconnect Diagram \(Figure 11.2 on p. 490\)](#)—shows detailed assembly and cable interconnect information and provides links to each part diagram. (p. 488) for additional information.

Before replacing any parts, review the following items:

- [Summary of Replacement Procedures \(p. 290\)](#)
- [Warnings and Cautions \(p. 293\)](#)
- [Static-Sensitive Device Handling \(p. 294\)](#)
- [Tools List \(p. 296\)](#)
- [Capacitor Discharge Tool \(p. 297\)](#)
- [Capacitor Discharging Procedure \(p. 298\)](#)
- [Discharging the C15 Pacing Capacitor \(p. 299\)](#)
- [Saving and Restoring the Setup Configuration \(p. 300\)](#)
- [Disassembling the Case \(p. 301\)](#)
- [Reassembling the Case \(p. 304\)](#)
- [Inside Front Case Diagram \(p. 309\)](#)
- [Software and Device Upgrades \(p. 485\)](#)

### Summary of Replacement Procedures

Replacement procedures are referenced and linked in the inside front case diagram (see [Inside Front Case Diagram \(p. 309\)](#)) and inside rear case diagrams (see [Inside Rear Case Diagrams \(p. 348\)](#)). Most activities start with disassembling the case (see [Disassembling the Case \(p. 301\)](#)).

**NOTE:** The “Procedures” link in the button bar at the bottom of each page returns you to this page to select the appropriate replacement procedure.

**NOTE:** To simplify cable referencing, the cable number only is sometimes used in the replacement procedures. For example, the power/system PCB cable (W01) may be referred to in procedures as the W01 cable.

### Inside Front Case Part Replacement Procedures

Choose from the following inside front case replacement procedures (in alphanumerical order):

- [Backlight PCB \(A08\) Replacement \(p. 315\)](#)
- [Backlight/Interface PCB Cable \(W06\) Replacement \(p. 333\)](#)
- [Display Shield Replacement \(p. 322\)](#)
- [Front Case Replacement \(p. 328\)](#)
- [Interface PCB \(A05\) Replacement \(p. 310\)](#)
- [LCD Display Assembly \(A11\) Replacement \(p. 324\)](#)
- [LCD Display Assembly/Interface PCB Cable \(W18\) Replacement \(p. 346\)](#)
- [Main Keypad \(A10\) Replacement \(p. 320\)](#)
- [Main Keypad/Interface PCB Cable \(W13\) Replacement \(p. 337\)](#)
- [Printer Assembly/Interface PCB Cable \(W16\) Replacement \(p. 341\)](#)
- [Printer Assembly/Chassis Ground Cable \(W19\) Replacement \(p. 347\)](#)
- [Printer Control Keypad \(A09\) Replacement \(p. 318\)](#)
- [Printer Control Keypad/Interface PCB Cable \(W12\) Replacement \(p. 336\)](#)
- [Speaker Assembly \(W17\) Replacement \(p. 343\)](#)
- [Speed Dial Assembly \(W15\) Replacement: \(p. 338\)](#)
- [System/Interface PCB Cable \(W04\) Replacement \(p. 332\)](#)
- [Therapy Connector Cable \(W11\) Replacement \(p. 334\)](#)

### Inside Rear Case Part Replacement Procedures

Choose from the following inside rear case replacement procedures (in alphanumerical order):

- [Battery Pins / Power PCB Cable \(W10\) Replacement \(p. 454\)](#)
- [Biphasic Cable \(W20\) Replacement \(p. 460\)](#)
- [Biphasic Module \(A22\)/Inductive Resistor \(A14\) Replacement \(p. 418\)](#)
- [CO2 Adapter Cable \(W30\) Replacement \(p. 473\)](#)
- [CO2 Inlet Connector Cable \(W28\) Replacement \(p. 470\)](#)
- [ECG Connector Cable \(W07\) Replacement \(p. 448\)](#)
- [Energy Storage Capacitor \(A15\) Replacement \(p. 391\)](#)
- [EMI Shield Replacement \(p. 425\)](#)
- [Interconnect Bracket \(A17\) Replacement \(p. 404\)](#)
- [Invasive Pressure Connector Assembly \(W33\) Replacement \(p. 475\)](#)
- [NIBP \(A21\)/CO2 \(A23\) Module Replacement \(p. 407\)](#)
- [NIBP Connector Replacement \(p. 426\)](#)
- [OEM PCB \(A06\) Replacement \(p. 381\)](#)
- [OEM PCB/CO2 Module Cable \(W26\) Replacement \(p. 466\)](#)
- [OEM PCB/NIBP Module Cable \(W27\) Replacement \(p. 468\)](#)
- [OEM PCB/SpO2 \(W21\) Module Cable Replacement \(p. 462\)](#)
- [Parameter Bezel Replacement \(p. 429\)](#)
- [Power/Contact PCB Cable \(W05\) Replacement \(p. 446\)](#)
- [Power PCB \(A03\) Replacement \(p. 373\)](#)
- [Power/System PCB Cable \(W01\) Replacement \(p. 443\)](#)
- [Power/Therapy PCB Cable \(W02\) Replacement \(p. 444\)](#)
- [Rear Case Replacement \(p. 435\)](#)
- [SpO2 Connector Cable \(W22\) Replacement \(p. 464\)](#)
- [SpO2 PCB \(A16\) Replacement \(p. 394\)](#)
- [System \(A01\)/Therapy \(A04\) PCB Assembly Replacement \(p. 352\)](#)
- [System Connector Cable \(W08\) and Auxiliary Connector Cable \(W09\) Replacement \(p. 451\)](#)
- [Temperature Cable Assembly \(W35\) Replacement \(p. 477\)](#)
- [Transfer Relay Assembly \(A13\) Replacement \(p. 388\)](#)

### Additional Part Replacement Procedures

Choose from the following procedures (in alphanumerical order) for parts outside the front or rear case.

- [Battery Pin Replacement \(p. 484\)](#)
- [Coin Battery Replacement \(p. 482\)](#)
- [Contact PCB \(A07\) Replacement \(p. 479\)](#)
- [Handle Replacement \(p. 441\)](#)
- [Paddle Retainer Cover Replacement \(p. 442\)](#)
- [Printer Assembly \(A12\) Replacement \(p. 480\)](#)
- [USB Flex Module \(W14\) Replacement \(p. 458\)](#)



### Warnings and Cautions

The following general warnings and cautions apply to all actions you may perform during maintenance of the LIFEPAK 15 monitor/defibrillator.

#### DANGER

**SHOCK HAZARD** Lethal voltages may be present even without operator action. Always discharge the energy storage capacitor prior to servicing. See the service manual “[Capacitor Discharging Procedure \(p. 298\)](#)” for detailed instructions.

#### WARNING

**SHOCK HAZARD** The pacing storage capacitor carry high voltage. Discharge the capacitors before handling.

**POSSIBLE SHOCK AND DEVICE DAMAGE** It is possible to pinch and damage wires during reassembly. To avoid pinching wires, carefully follow reassembly instructions.

#### CAUTION

**POSSIBLE COMPONENT DAMAGE** The PCBs contain static-sensitive devices (SSDs). To avoid damage, observe the special handling practices in [Static-Sensitive Device Handling \(p. 294\)](#). PCBs contain high impedance circuitry; always handle the PCB by holding on to the edges.

## Static-Sensitive Device Handling

### About SSD Handling

Many electronic semiconductor devices (such as MOS ICs, FETs, optical isolators, or film resistors) can be damaged by the discharge of static electricity. Static charge buildup is very common. Static discharges commonly occur when the operator wears synthetic clothes and transfers the charge to any object touched. These discharges can damage or destroy static-sensitive devices (SSDs). In most cases, the discharge is not even perceptible to the person who causes it.

To prevent static discharge damage to SSDs, observe the following precautions during any open-case test, maintenance, or repair procedures:

### Look for SSD Symbol

SSDs are identified with the following warning symbol:



### Use Static-Dissipative Mat

Always perform repair or maintenance on a static-dissipative mat that is connected to earth ground.

### Wear a Wrist Strap

Always wear a conductive wrist strap connected to the mat and to ground except when working on energized equipment or when discharging high voltage circuits. The strap must be snug enough to make good contact against bare skin.

#### WARNING

**SHOCK HAZARD** Remove the wrist strap when working on energized equipment or when discharging high voltage circuits.

### Transport and Store PCBs Properly

Transport and store PCBs in anti-static racks or inside conductive bags. Label the package containing the PCBs as static-sensitive.

### Keep Work Area Static-Free

Keep static-generating products, such as styrofoam cups or trays, away from the work area. Connect all electrical equipment, such as soldering irons and test equipment, to ground with a three-prong plug.

### Test Work Area Routinely

Test all the anti-static parts of the work area (mat, straps, cables) routinely. Keep a log of the test results.

### Tools List

The suggested list of tools for the LIFEPAK 15 monitor/defibrillator replacement procedures is as follows:

- Static-dissipative mat and wrist strap
- Anti-static rack and/or conductive bags
- Capacitor discharge tool (information about [Capacitor Discharge Tool \(p. 297\)](#))
- Torque screwdriver(s)—required torque settings are 2.0, 4.0, 6.8, and 10.0 in-lb

Torque in-lb	2.0	4.0	6.8	10.0
Torque in-oz	32	64	108.8	160
Torque cNm	22.5	45	77	113

- Point 0 power drive bit (P0)- Phillips tip for 2-56 screws
- Point 1 power drive bit (P1)- Phillips tip for 4-40 screws (shaft length of 2" and 6")
- Point 2 power drive bit (P2)- Phillips tip for 6-32 screws (shaft length of 6")
- T10 torx power drive bit
- T15 torx power drive bit
- 4 mm modified thin wall socket for battery pins (Physio-Control tool #3300955)
- 1/4" socket
- 1/2" deep socket
- 9/16" deep socket
- 3/4" modified deep socket (Physio-Control tool #3305448)
- 3/8" nutdriver
- Small, slotted screwdriver for label removal
- Diagonal cutter
- Needle nose pliers
- 1.5" (hard) putty knife
- See [PIP – Test Equipment Requirements \(p. 102\)](#) and [TCP – Test Equipment Requirements \(p. 191\)](#) for additional test tools required for performance testing

### Capacitor Discharge Tool

A capacitor discharge tool is used to discharge the energy storage capacitor (see [Capacitor Discharging Procedure](#) (p. 298)) and the pacing capacitor (see [Discharging the C15 Pacing Capacitor](#) (p. 299)).

#### DANGER

**SHOCK HAZARD** Capacitor discharge tools that are not designed and labeled for biphasic use are inadequate for use on biphasic defibrillators and will take several minutes to discharge the energy capacitor.

The illustration shows how the biphasic capacitor discharge tool is constructed. The materials used in this example are:

- 10 k $\Omega$ , 2 W resistor (ten 1 K $\Omega$  2 W), high-voltage
- 5 M $\Omega$ , 5 W resistor, high-voltage
- Neon lamp, NE76, NE2, or NE2H
- 8 AWG copper wire
- Clear plastic tubing, capable of insulating 10 kV
- 10 kV insulation
- RTV silicone rubber sealant

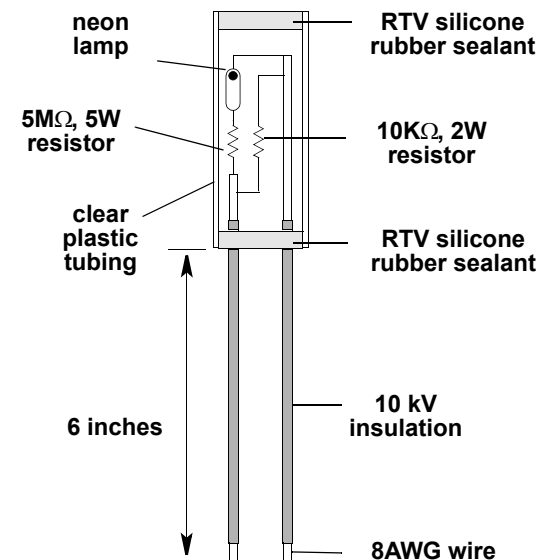

Figure 10.1—Capacitor discharge tool

### Capacitor Discharging Procedure

After disassembling the case as described in [Disassembling the Case \(p. 301\)](#), immediately discharge the energy storage capacitor using the capacitor discharge tool as described in [Using the Capacitor Discharge Tool \(p. 298\)](#). The discharge points are located through holes on the interconnect bracket in the rear case.

#### Using the Capacitor Discharge Tool

- ◆ To use the capacitor discharge tool:
  1. Place one probe on a discharge point and hold it steady.
  2. Place the other probe on the remaining discharge point and hold both probes steady.
  3. Observe the neon lamp inside the capacitor discharge tool. If a charge of approximately 90 volts is present, the neon lamp will light.

#### DANGER

**SHOCK HAZARD** Lethal voltages may be present even without operator action. Do not assume the capacitor is uncharged if the neon lamp does not light! There may still be a charge on the capacitor. Do not touch capacitor terminals until completing the discharge operation.

4. Continue holding the probes on the points indicated for at least 30 seconds after the neon lamp is no longer lit.

**NOTE:** You may need to disconnect the P51 connector of W20 from the therapy PCB to gain access to discharge points.

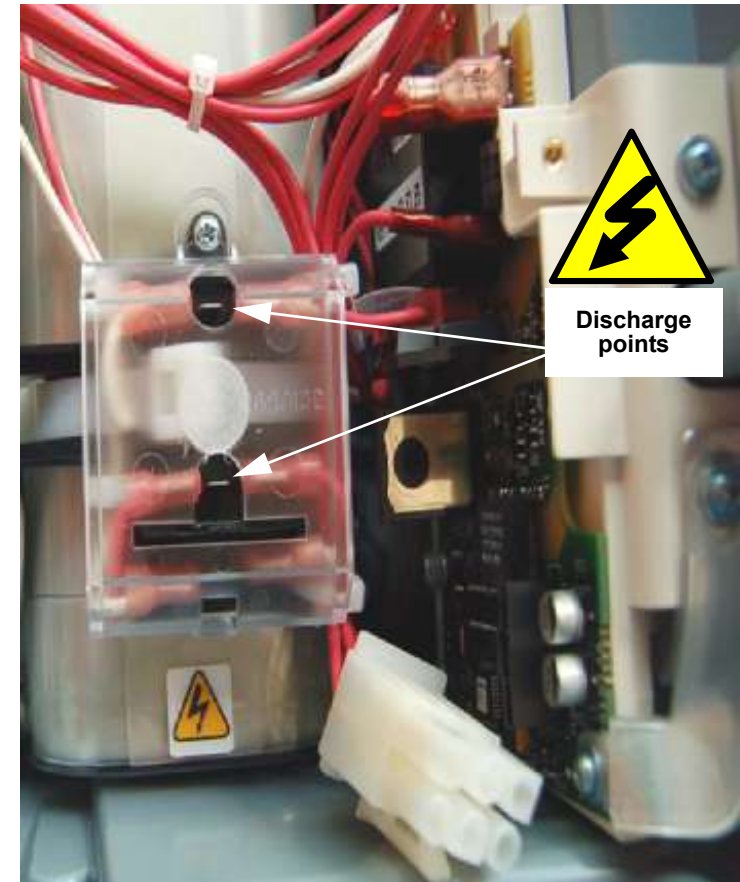

Figure 10.2—Location of energy storage capacitor discharge points

### Discharging the C15 Pacing Capacitor

#### Location of Discharge Points

After removing the system and therapy PCBs as described in [System \(A01\)/Therapy \(A04\) PCB Assembly Replacement \(p. 352\)](#), immediately discharge the Pacing Capacitor using the capacitor discharge tool (see [Using the Capacitor Discharge Tool \(p. 298\)](#)). The discharge points are located at resistors R5 and R20 on the therapy PCB.

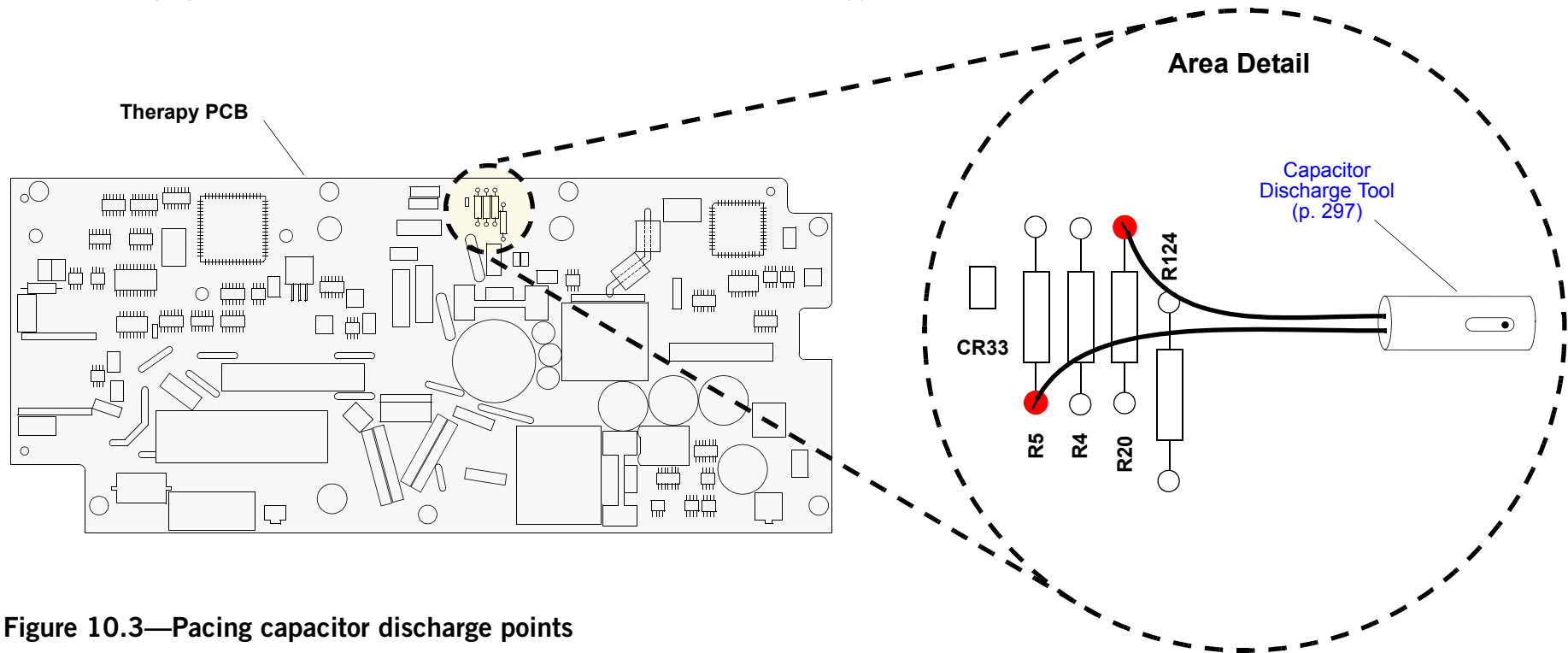

Figure 10.3—Pacing capacitor discharge points

### Saving and Restoring the Setup Configuration

Before beginning any repair action, the existing setup configuration should be preserved using either of the following methods:

- The best method is to store setup options to a computer using the LIFEPAK Defibrillator Software Solutions Configuration Setup Tool before performing service.
- The second method is to print the existing setup configuration, complete repairs, and then manually reconfigure the device.

**NOTE:** The LIFEPAK Defibrillator Software Solutions Configuration Setup Tool is a Windows®-based application designed to assist you in managing the setup options in your LIFEPAK 15 monitor/defibrillator. You can download the tool from [Physio-Control.com](http://Physio-Control.com).

#### Printing the Setup Configuration

- ◆ To print the setup configuration:
  1. Display the Setup mode (see [Setup Mode \(p. 92\)](#)).
  2. Select PRINT DEFAULTS to print the device setup configuration. Save this printout for future reference.
  3. Turn the device OFF.

#### Restoring the Setup Manually

- ◆ To restore the setup configuration manually:
  1. Display the Setup menu.
  2. Using the printout from the preceding steps, check the settings in each menu and revise as necessary to match the printout. The printout items are organized in the same manner as the Setup menu (General, Manual Mode, AED Mode, and so forth). See the LIFEPAK 15 Monitor/Defibrillator Setup Options instructions provided with your device.
  3. Turn the device OFF.



### Disassembling the Case

Refer to [Front Parts Diagrams and Parts List \(p. 497\)](#) and [Rear Diagrams and Parts List \(p. 519\)](#).

- ◆ To disassemble the case halves: *12 steps, (Page 1 of 3)*
  1. If applicable, remove carrying case.
  2. Remove all cables and patient connections, and then remove the batteries.
  3. Remove the four front mounting screws (3207361-375) from the bumpers.
  4. Remove the four rear mounting screws (3207361-375) from the bumpers.
  5. Remove the bumpers (3207307-001 and 3206968-000) from the case and set aside.



Figure 10.4—Bumper screw locations

- ◆ To disassemble the case halves: *(Continued) 12 steps, (Page 2 of 3)*
  6. Lay the defibrillator face-down on a protective surface to prevent damage, and then remove the 14 case screws ([201407-069](#)). Discard the screws.
  7. Holding the case halves together, position the device face-up on your work surface. Lift the front case assembly slightly above the rear to access the connecting cables.

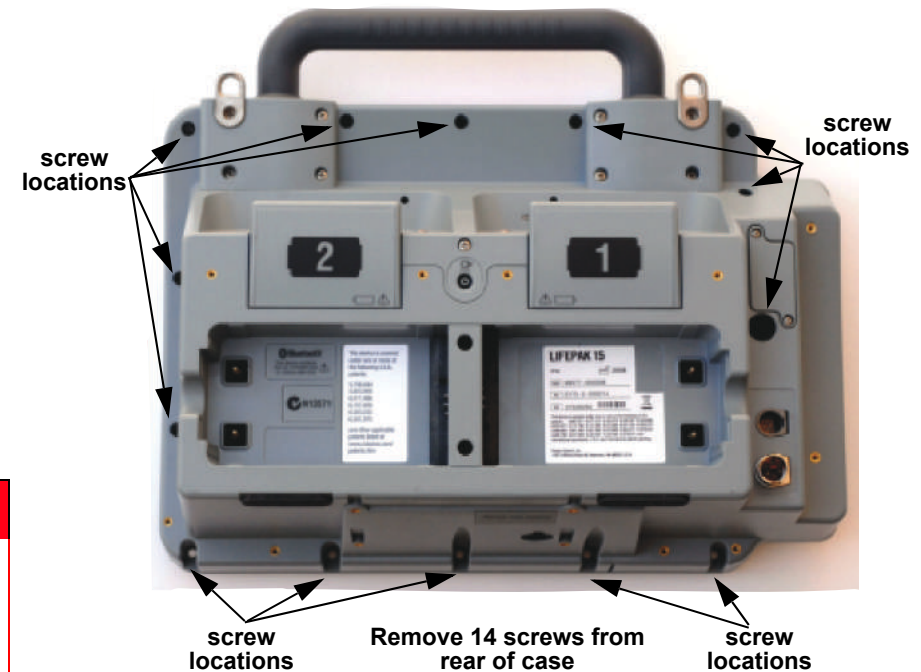

Figure 10.5—Screw locations

### DANGER

**SHOCK HAZARD** Lethal voltages may be present even without operator action. Always discharge the energy storage capacitor prior to servicing. See the service manual "[Capacitor Discharging Procedure \(p. 298\)](#)" for detailed instructions.

- ◆ To disassemble the case halves: *(Continued) 12 steps, (Page 3 of 3)*
  8. Disconnect the P2 system/interface flex cable connector (W04) ( [3206991-003](#)) from the system PCB (see [Figure 11.22 on p. 563](#)) in the rear case.
  9. Disconnect the P23 therapy ribbon cable connector (W11) ( [3207044-002](#)) in the front case from the therapy PCB (see [Figure 11.24 on p. 565](#)).
  10. Disconnect the J24 therapy cable connector (W11) from the P24 transfer relay connector (A13) (see [Figure 11.33 on p. 574](#)).
  11. Separate the front and rear cases halves.
  12. Before continuing any further, discharge the energy storage capacitor using the discharge tool (see [Capacitor Discharging Procedure \(p. 298\)](#)).

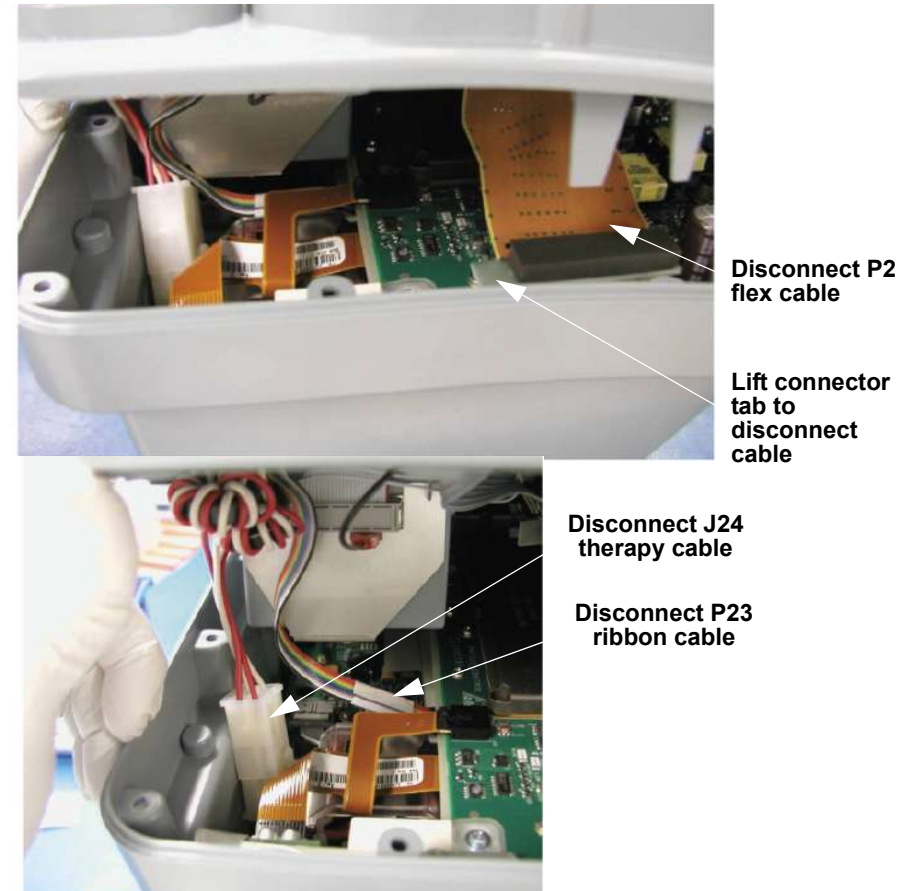

Figure 10.6—Disconnection points

### Reassembling the Case

- ◆ To reassemble the case halves: *13 steps, (Page 1 of 5)*
  1. Position the front case over the rear case.
  2. Connect the P23 therapy ribbon cable connector (W11) (3207044-002) from the front case to J23 of therapy PCB (Figure 11.24 on p. 565).
  3. Connect the J24 6-pin block therapy cable connector (W11) to P24 transfer relay connector (A13).



Connect J24  
therapy cable

Connect P23  
ribbon cable

- ◆ To reassemble the case halves: *(Continued) 13 steps, (Page 2 of 5)*
- 4. Carefully connect the P2 system/interface flex cable connector (W04) ([3206991-003](#)) to the system PCB in the rear case ([Figure 11.22 on p. 563](#)).
- 5. Ensure the case seal is in place in the groove along outside edge of front case. Fold the front and rear case halves together. Route the therapy cable wires away from the edge of the case to avoid pinching.

### CAUTION

**POSSIBLE COMPONENT DAMAGE** - Ensure the therapy cable wires are routed away from the edge of case to avoid wire pinching (see [Figure 10.6 on p. 303](#)).

**POSSIBLE MOISTURE LEAKAGE** - Visually inspect the mating surfaces between the front and the rear case halves before and after fastening them together to ensure that they are even.

**PREVENT VIBRATION DAMAGE** In order to meet vibration specifications (for example, prevent loosening of case screws), use new screws ([201407-069](#)) when assembling the case and torque to specified value.

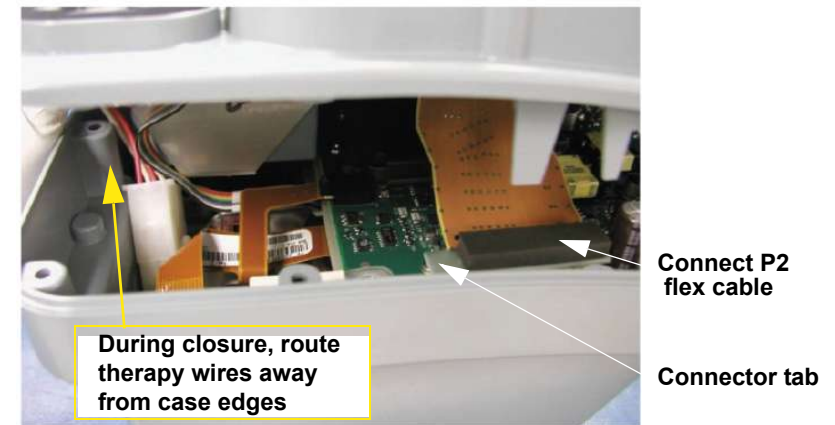

Figure 10.7—Connection points

- ◆ To reassemble the case halves: *(Continued) 13 steps, (Page 3 of 5)*
  6. Install 14 new screws ([201407-069](#)); torque to 10.0 in-lb using a P2 bit.

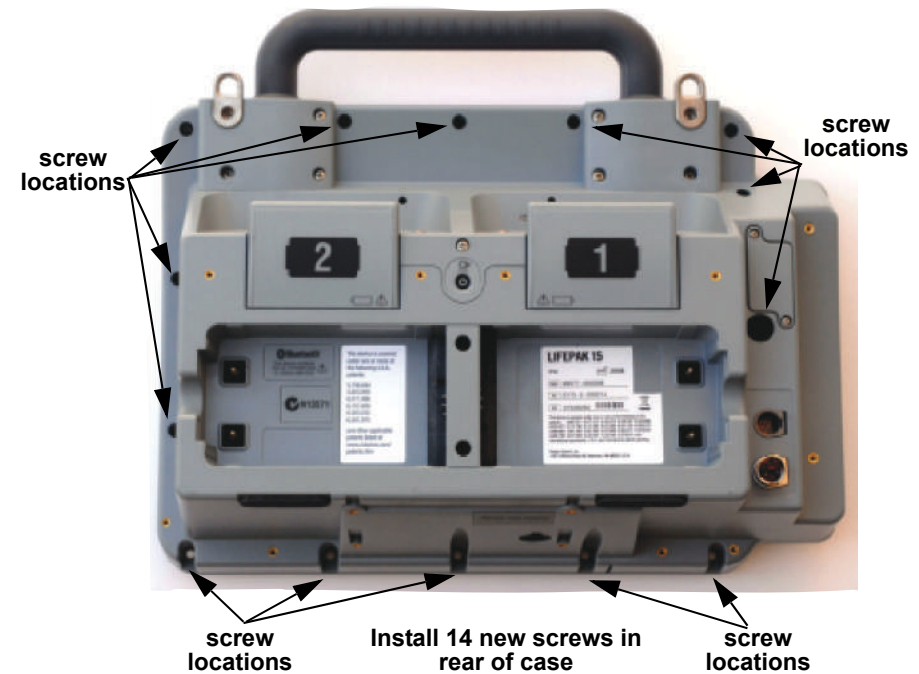

Figure 10.8—Screw locations

◆ To reassemble the case halves: *(Continued) 13 steps, (Page 4 of 5)*

7. Reinstall the right corner bumper ([3207307-001](#)) with 4 screws ([3207361-375](#)); torque to 10.0 in-lb using Torx T-15 bit.
8. Reinstall the left corner bumper ([3206968-000](#)) with 4 screws ([3207361-375](#)); torque to 10.0 in-lb using Torx T-15 bit.

**NOTE:** If new bumpers and feet are required, use [Guard & Feet Repair Kit \(MIN 3305431-019\)](#) (p. 626).



Figure 10.9—Bumper screw locations



◆ To reassemble the case halves: *(Continued) 13 steps, (Page 5 of 5)*

9. Install the batteries.

**NOTE:** Pay special attention to the SERVICE indicator as you turn on the device in the next step.

10. If applicable, reinstall carrying case.

11. Turn the device ON and observe the SERVICE indicator.

- If the SERVICE indicator is OFF, continue with step 12.
- If the SERVICE indicator is ON, skip to step 13.
- If the device gives no indication that power is on, review information in Note below.

12. Complete the [Test and Calibration Procedures \(TCP\) \(p. 188\)](#), followed by the [Performance Inspection Procedures \(p. 98\)](#).

13. Error codes have been written to the Service Log. Continue to [Processing Service Log Codes \(p. 235\)](#).

**NOTE:** If there is no indication of power, either the batteries are dead or no batteries are installed, or the W04 cable connection was not made when the case was reassembled. The W04 cable is the flex cable between the front case and rear case. Check the batteries and, if they are charged, disassemble the case as described in [Disassembling the Case \(p. 301\)](#) and check the W04 cable.



### Inside Front Case Diagram

Use the following diagram after disassembling the case as described in [Disassembling the Case \(p. 301\)](#).

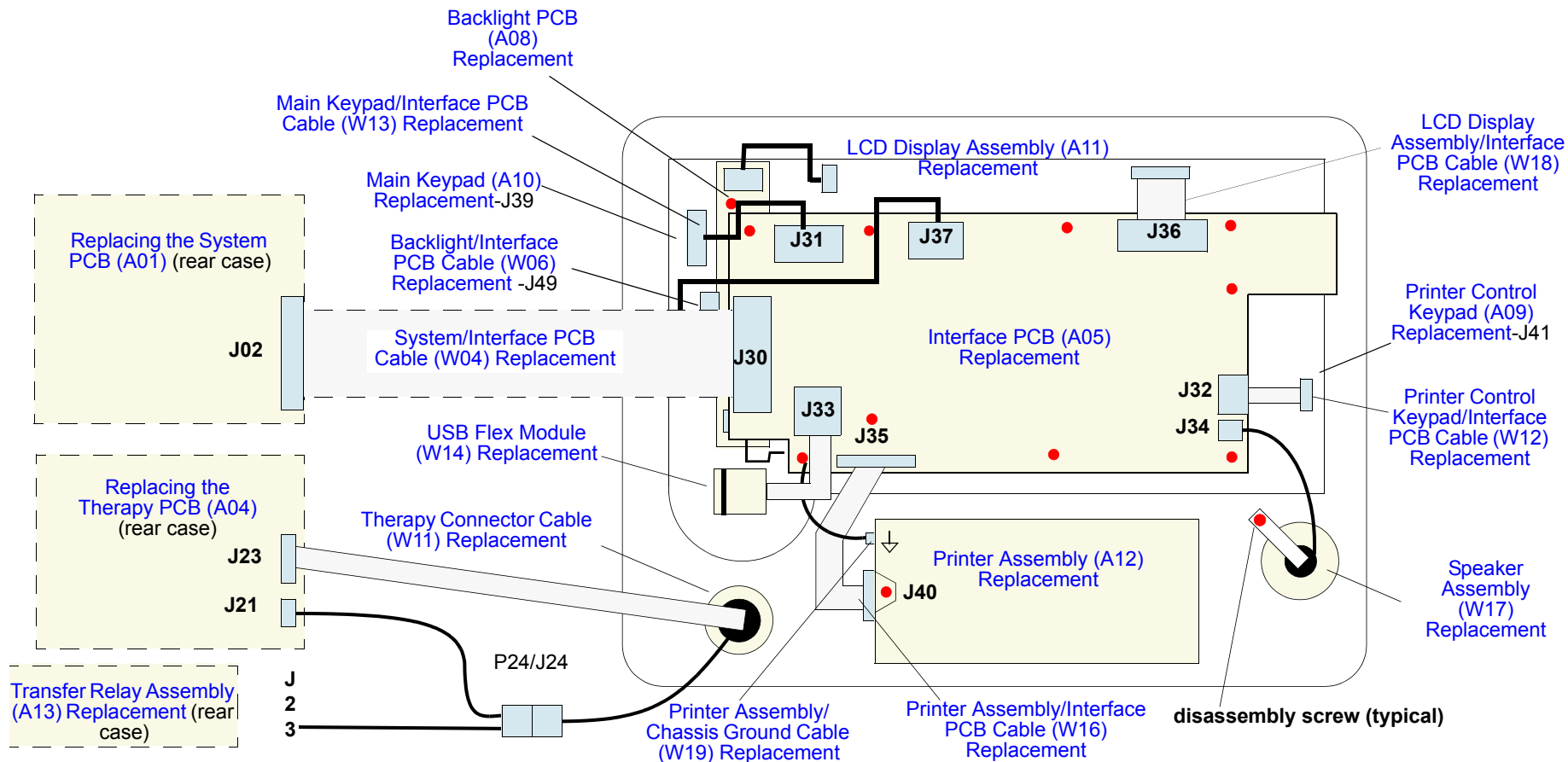

### Interface PCB (A05) Replacement

#### Interface PCB Replacement Figures

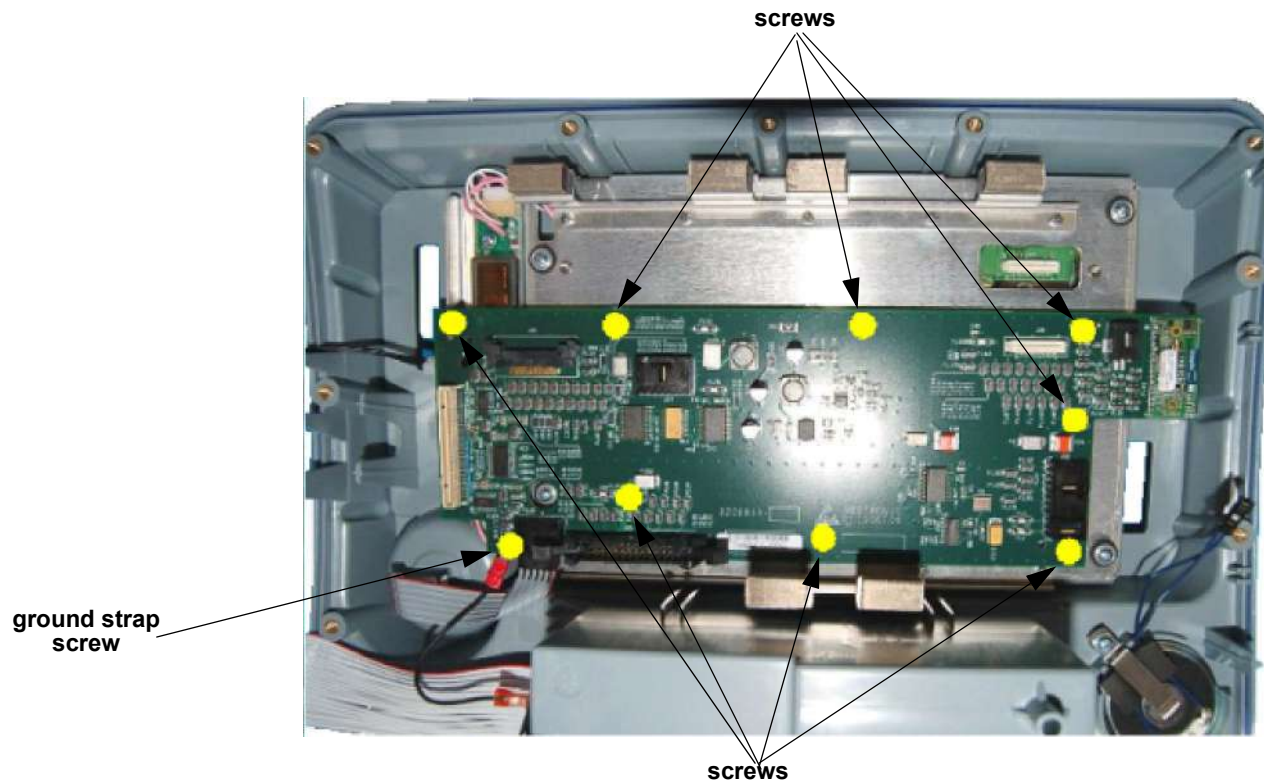

Figure 10.10—Interface PCB screw locations



Figure 10.11—Interface PCB cable connection locations - view 1 of 2



Figure 10.12—Interface PCB cable connection locations - view 2 of 2

### Removing the Interface PCB (A05)

Refer to [Interface PCB Replacement Figures \(p. 310\)](#) and [Inside Front Case Diagram \(p. 309\)](#).

- ◆ To remove the interface PCB ([3206815](#)) or V2 interface PCB ([3306367](#)) from the front case:
  1. Disassemble the case as described in [Disassembling the Case \(p. 301\)](#).
  2. Disconnect the connectors (from top left, counterclockwise) as follows (see [Figure 10.11 on p. 311](#) and [Figure 10.12 on p. 312](#)):
    - ~ J31 – Spread the connector locking tab and disconnect the main keypad interface PCB cable (W13, [3207388-001](#)).
    - ~ J37 – Press the connector locking tab and disconnect the backlight interface PCB cable (W06, [3206992-000](#)).
    - ~ J36 – Disconnect the LCD interface PCB cable (W18, [3206990-001](#)).
    - ~ J32 – Press the connector locking tab and disconnect the printer control keypad interface PCB cable (W12, [3206989-000](#)).
    - ~ J34 – Press the connector locking tab and disconnect the speaker interface PCB wire (W17, [3009726-03](#)).
    - ~ J35 – Spread the connector locking tabs and eject the printer interface cable (W16, [3009724-001](#)).
    - ~ J33 – Press the connector locking tab and disconnect the cable for the speed dial (W15, [3011128-002](#)).
  3. (If replacing the interface PCB) Disconnect the System/Interface cable as described in [System/Interface PCB Cable \(W04\) Replacement \(p. 332\)](#).
  4. Remove the screw holding the ground strap. Discard the screw.
  5. Remove the eight remaining screws ([202253-761](#)) (see [Figure 10.10 on p. 310](#)). Discard the screws.



### Installing the Interface PCB (A05)

Refer to [Interface PCB Replacement Figures \(p. 310\)](#) and [Inside Front Case Diagram \(p. 309\)](#).

◆ To install the interface PCB into the front case:

**NOTE:** If a new interface PCB is required, install the [Interface PCBA Repair Kit, V1 \(MIN 3305431-005\)](#) or [Interface PCBA Repair Kit, V2 \(MIN 3305431-029\)](#).

1. Attach the interface PCB to the bracket with the eight new screws ([202253-761](#)); torque to 6.8 in-lb (see [Figure 10.10 on p. 310](#)).
2. Install the ground strap (W19) with one new screw ([202253-761](#)); torque to 6.8 in-lb (see [Figure 10.10 on p. 310](#)).
3. Install the connectors clockwise, as follows (make sure all connector locking tabs are positioned to secure their respective connectors) (see [Figure 10.11 on p. 311](#) and [Figure 10.12 on p. 312](#)):
  - ~ J31 – Install the main keypad interface PCB cable (W13, [3207388-001](#)).
  - ~ J37 – Install the backlight interface PCB cable (W06, [3206992-000](#)).
  - ~ J36 – Install the LCD interface PCB cable (W18, [3206990-001](#)).
  - ~ J32 – Install the printer control keypad interface PCB cable (W12, [3206989-000](#)).
  - ~ J34 – Install the speaker interface PCB wire (W17, [3009726-03](#)).
  - ~ J35 – Install the printer interface cable (W16, [3009724-001](#)).
  - ~ J33 – Install the speed dial cable (W15, [3011128-002](#)).
4. If the interface PCB was replaced, install the system/interface cable to the interface PCB as described in [System/Interface PCB Cable \(W04\) Replacement \(p. 332\)](#)
5. Reassemble the case as described in [Reassembling the Case \(p. 304\)](#).

### Backlight PCB (A08) Replacement

The backlight PCB replacement consists of:

- [Removing the Backlight PCB \(A08\) \(p. 316\)](#)
- [Installing the Backlight PCB \(A08\) \(p. 317\)](#)

Refer to [Inside Front Case Diagram \(p. 309\)](#).

### Removing the Backlight PCB (A08)

- ◆ To remove the backlight PCB from the front case:
  1. Disassemble the case as described in [Disassembling the Case \(p. 301\)](#).
  2. Remove the interface PCB as described in [Removing the Interface PCB \(A05\) \(p. 313\)](#).
  3. Disconnect the backlight/interface PCB cable (W06) ([3206992-000](#)). Press the connector locking tab and disconnect the W06 cable from the interface PCB at J37. Then place even pressure on the cable and ease the W06 cable out of the connector on the Backlight PCB.
  4. Remove the two backlight inverter mounting screws ([202253-761](#)). Discard the screws.
  5. Lift the backlight inverter off of the display assembly and disconnect the two end connectors from the LCD display assembly.
  6. Remove the inverter cover ([3207252-001](#)).

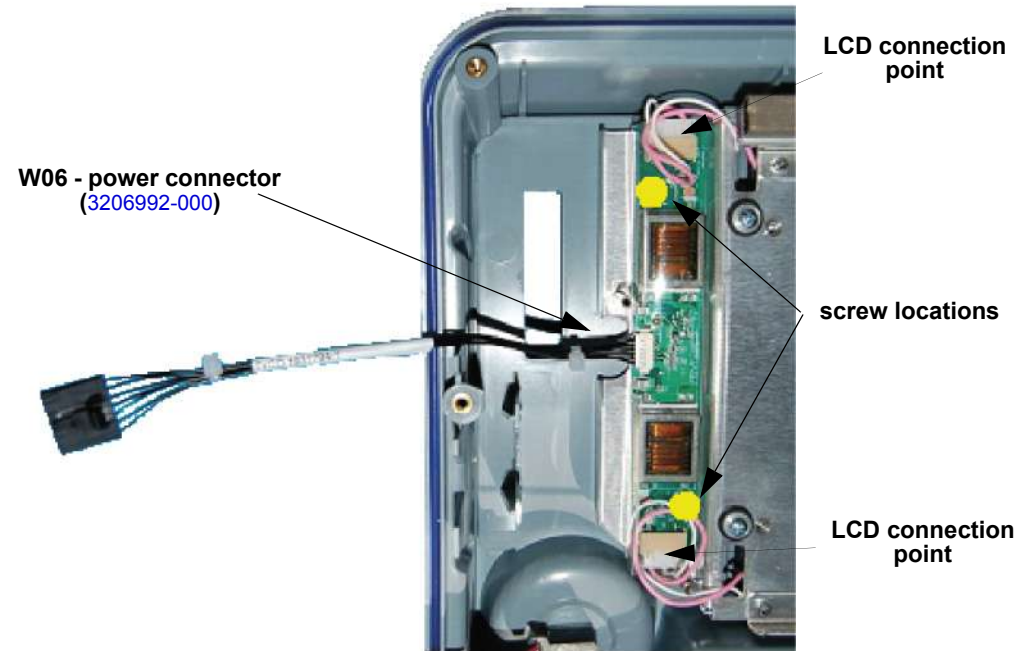

Figure 10.13—Screw location and cable connection for backlight PCB



### Installing the Backlight PCB (A08)

- ◆ To install the backlight PCB into the front case:

**NOTE:** If a new backlight PCB is required, install the [Backlight Inverter Repair Kit \(MIN 3305431-012\)](#).

1. Place the inverter cover ([3207252-001](#)) over the backlight PCB.
2. Connect the two end connectors to the LCD display assembly.
3. Connect the backlight/interface PCB cable (W06) ([3206992-000](#)) to backlight power connector.
4. Place the backlight inverter on the display assembly and install with two new screws ([202253-761](#)); torque to 6.8 in-lb.
5. Feed excess length of LCD wires into backlight inverter cover.
6. Install the interface PCB as described in [Installing the Interface PCB \(A05\) \(p. 314\)](#).
7. Reassemble the case as described in [Reassembling the Case \(p. 304\)](#).

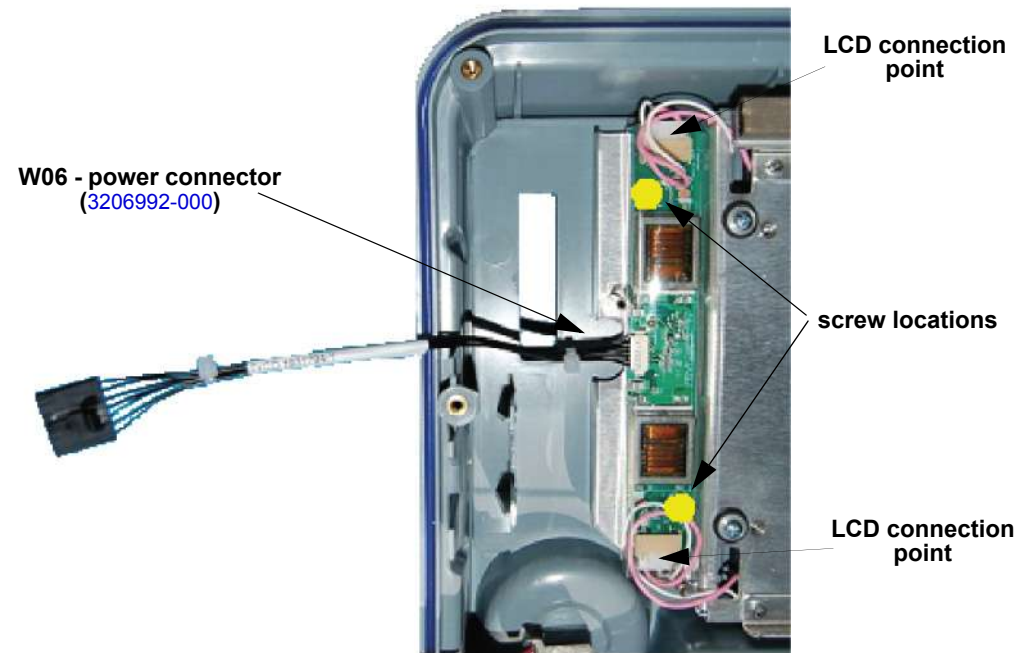

Figure 10.14—Screw location and cable connection for backlight PCB

### Printer Control Keypad (A09) Replacement

Printer control keypad replacement consists of the following:

- [Removing the Printer Control Keypad \(A09\) \(p. 319\)](#)
- [Installing the Printer Control Keypad \(A09\) \(p. 319\)](#)



Figure 10.15—Printer control keypad replacement

### Removing the Printer Control Keypad (A09)

Refer to [Figure 10.15 on p. 318](#).

- ◆ To remove the printer control keypad from outside the front case:
  1. Using a very thin, wide, flat-edged tool (example, 1.5" putty knife), gently pry one edge of the printer control keypad until it is released from its adhesive mount. **Take care not to damage the case.**
  2. Pull the printer control keypad away from the case, extending part of the W12 cable ([3206989-000](#)) (see [Figure 11.52 on p. 593](#)) through the keypad opening.
  3. Disconnect the W12 cable from printer control keypad at J41. Make sure the W12 cable does not fall back into the front case.

### Installing the Printer Control Keypad (A09)

Refer to [Figure 10.15 on p. 318](#).

**NOTE:** Before installing the new printer control keypad, verify that the shelf-life date printed on the printer control keypad package has not expired.

- ◆ To install the new printer control keypad (see [Table 11.11 on page 538](#) for keypad part numbers):
  1. Using a soft, lint-free cloth and isopropyl alcohol, gently remove old adhesive from the printer control keypad cavity on the front case.
  2. Connect the W12 cable ([3206989-000](#)) to the printer control keypad at J41.
  3. Check that connector locking tab is securely latched.
  4. Remove the protective covering from the keypad adhesive surface and press the keypad firmly and evenly into the keypad cavity on the front case.

### Main Keypad (A10) Replacement

Main keypad replacement consists of the following:

- [Removing the Main Keypad \(A10\) \(p. 321\)](#)
- [Installing the Main Keypad \(A10\) \(p. 321\)](#)



Figure 10.16—Main keypad replacement

### Removing the Main Keypad (A10)

Refer to [Figure 10.16 on p. 320](#).

- ◆ To remove the main keypad from outside the front case:
  1. Using a very thin, wide, flat-edged tool (example, 1.5" putty knife), gently pry one edge of the main keypad until it is released from its adhesive mount. **Take care not to damage the case.**
  2. Pull the main keypad away from the case, extending part of the W13 cable through the keypad opening.
  3. Spread the locking tabs and disconnect the W13 cable (3207388-001) (see [Figure 11.53 on p. 594](#)) from main keypad at J39. Make sure the W13 cable does not fall back into the front case.

### Installing the Main Keypad (A10)

Refer to [Figure 10.16 on p. 320](#).

**NOTE:** Before installing the new main keypad, verify that the shelf-life date printed on the main keypad package has not expired.

- ◆ To install the new main keypad (see [Table 11.12 on page 540](#) for keypad part numbers):
  1. Using a soft, lint-free cloth and isopropyl alcohol, gently remove old adhesive from the main keypad cavity on the front case.
  2. Connect the W13 cable (3207388-001) to the main keypad at J39.
  3. Check that connector locking tab is securely latched.
  4. Remove the protective covering from the keypad adhesive surface, and press the keypad firmly and evenly into the keypad cavity on the front case.

### Display Shield Replacement

Refer to [Inside Front Case Diagram \(p. 309\)](#) and [Figure 11.5 \(p. 498\)](#).

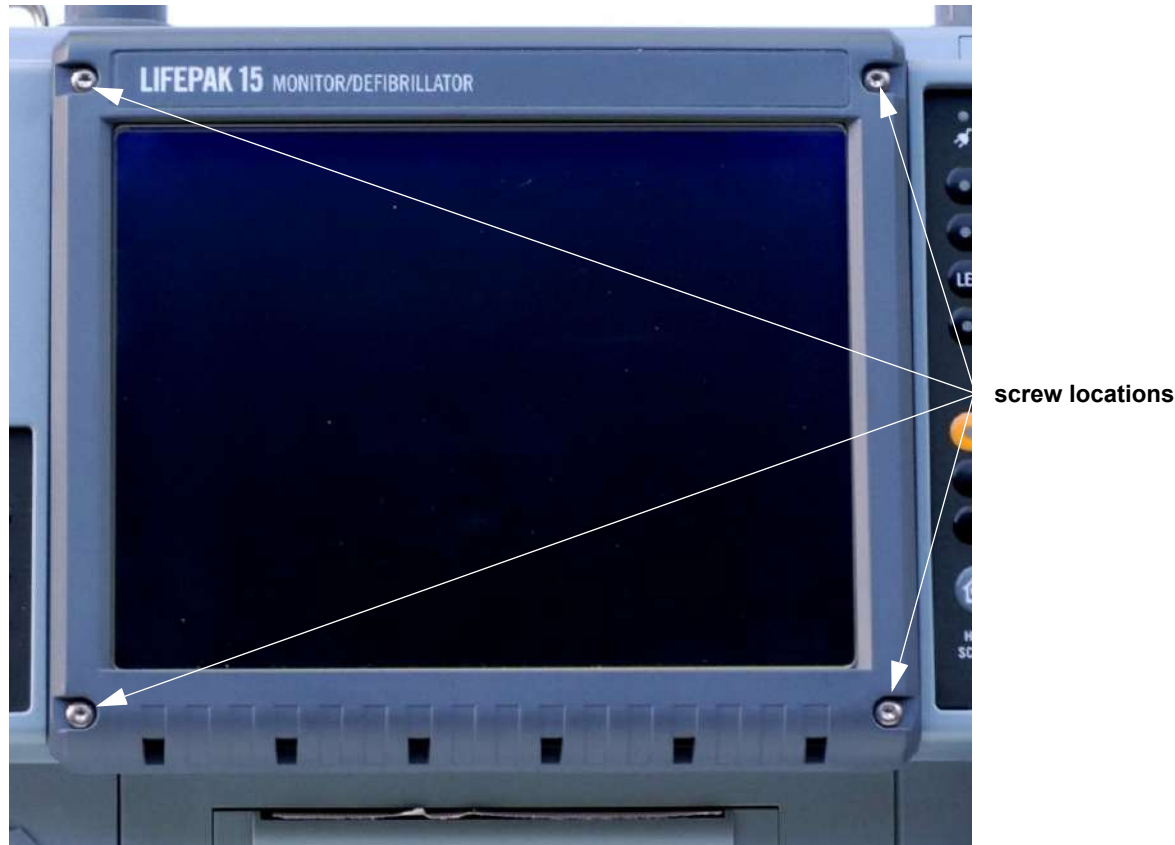

Figure 10.17—Display shield screw locations

### Removing the Display Lens Shield

Refer to [Figure 10.17 on p. 322](#).

- ◆ To remove the display shield from outside the front case:
  1. Remove the four screws ([3207367-312](#)) from the display shield.
  2. Lift the display shield off of the front case assembly.

### Installing the Display Lens Shield

Refer to [Figure 10.17 on p. 322](#).

- ◆ To install the display shield onto the front case:
  - NOTE:** If new display shield is required, install the [Display Shield Repair Kit \(MIN 3305431-018\) \(p. 625\)](#).
    1. Make sure the display lens surface and shield are completely clean and dust free before installing.
    2. Install the shield with four screws ([3207367-312](#)); torque to 6.8 in-lb using a T10 bit.
    3. If installing a new display lens shield, Label Set [3207318-XXX](#) (see [Table 11.14 on page 544](#)) is required. Clean display shield frame with isopropyl alcohol and install label number 10.

### LCD Display Assembly (A11) Replacement

The LCD display assembly replacement includes:

- [Removing the LCD Display Assembly \(A11\)](#) (p. 325)
- [Installing the LCD Display Assembly \(A11\)](#) (p. 325)

Refer to [Inside Front Case Diagram](#) (p. 309).

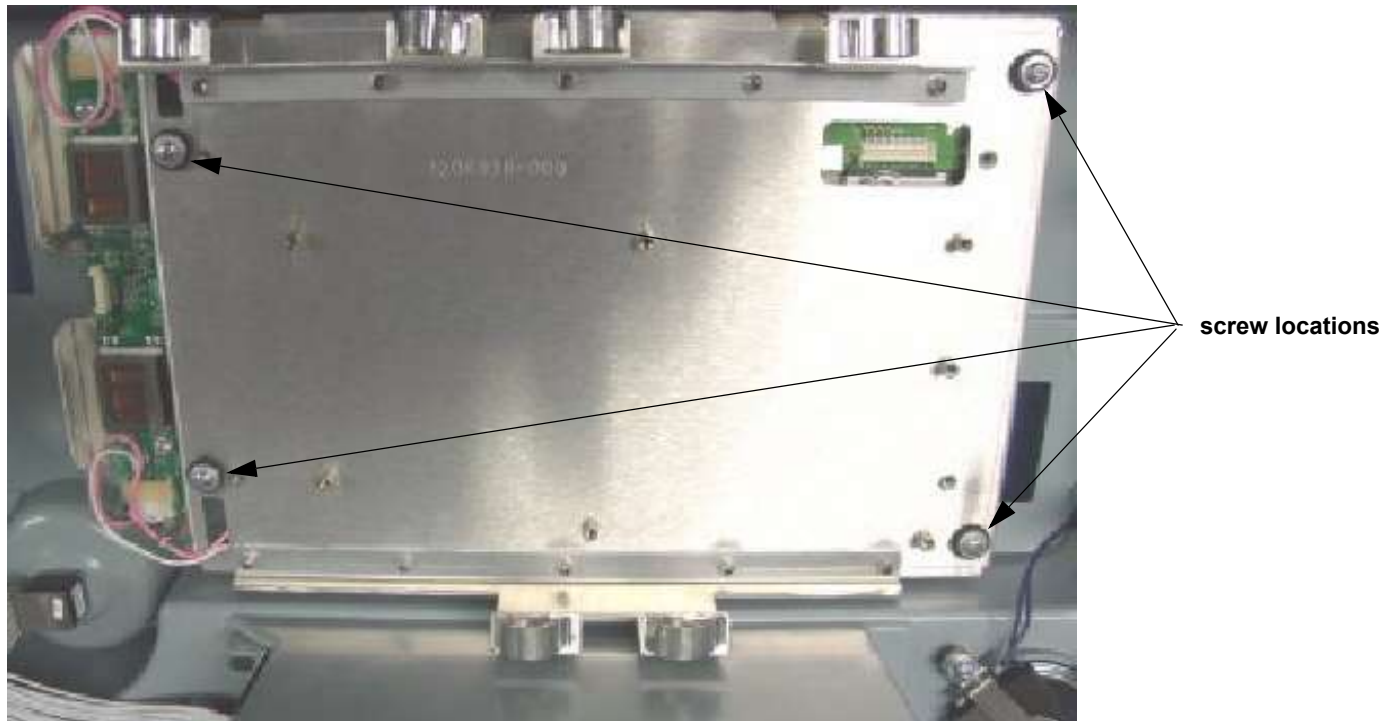

Figure 10.18—LCD display assembly screw locations



### Removing the LCD Display Assembly (A11)

- ◆ To remove the LCD display assembly from the front case ([Inside Front Case Diagram \(p. 309\)](#)):
  1. Disassemble the case as described in [Disassembling the Case \(p. 301\)](#).
  2. Remove the interface PCB as described in [Removing the Interface PCB \(A05\) \(p. 313\)](#).
  3. Remove the backlight inverter as described in [Removing the Backlight PCB \(A08\) \(p. 316\)](#).
  4. Remove the display/interface cable as described in [Removing the LCD Display Assembly/Interface PCB Cable \(W18\) \(p. 346\)](#).
  5. Remove the four LCD bracket mounting screws ([202253-764](#)). Discard the screws.
  6. Remove the LCD mounting bracket from front case and place on workspace with LCD display assembly facing up.
  7. Remove four screws ([202253-761](#)) from the LCD display assembly. Discard the screws.
  8. Remove the LCD display from the LCD bracket.

### Installing the LCD Display Assembly (A11)

- ◆ To install the LCD display assembly into the front case:
  - NOTE:** If a new LCD display assembly is required, use [Display Repair Kit \(MIN 3305431-013\) \(p. 622\)](#).
  - 1. Make sure both the LCD display assembly screen and the front case lens are completely clean and dust free before reinstalling.
  - 2. Place the LCD mounting bracket on workspace with display side facing up. Route LCD wires through Bracket openings.
  - 3. Install the LCD display assembly onto the display mounting bracket with four new screws ([202253-761](#)); torque to 6.8 in-lbs.
  - 4. (If installing a new LCD display) Remove protective layer from LCD screen.
  - 5. Place the LCD mounting bracket in the front case and secure with four new screws ([202253-764](#)); torque to 6.8 in-lb.
  - 6. Install the display/interface cable as described in [Installing the LCD Display Assembly/Interface PCB Cable \(W18\) \(p. 346\)](#).
  - 7. Install the backlight inverter as described in [Installing the Backlight PCB \(A08\) \(p. 317\)](#).
  - 8. Install the interface PCB as described in [Installing the Interface PCB \(A05\) \(p. 314\)](#).
  - 9. Reassemble the case as described in [Reassembling the Case \(p. 304\)](#).

### Display Lens Replacement

Refer to [Inside Front Case Diagram \(p. 309\)](#) and [Figure 11.5 \(p. 498\)](#).

#### Removing the Display Lens

- ◆ To remove the display lens from outside the front case:

**NOTE:** Removing the front lens requires high direct pressure to remove. Suggest instead replacing front case; use [Front Case Repair Kit \(MIN 3305431-023\)](#) (p. 628)

1. Disassemble the case as described in [Disassembling the Case \(p. 301\)](#).
2. Remove the display shield as described in [Removing the Display Lens Shield \(p. 323\)](#).
3. Remove the interface PCB as described in [Removing the Interface PCB \(A05\) \(p. 313\)](#).
4. Remove the LCD assembly as described in [Removing the LCD Display Assembly \(A11\) \(p. 325\)](#).
5. From the inside of front case, push out the display lens.



Figure 10.19—Display lens location

### Installing the Display Lens

Refer to [Figure 10.19 on p. 326](#).

- ◆ To install the display lens onto the front case:
  1. Using a soft, lint-free cloth and isopropyl alcohol, gently remove old adhesive from lens frame on the front case.
  2. Remove adhesive liner from display lens and install on front case. Press down firmly all around edge of display lens.
  3. Make sure the display lens surface is completely clean and dust free before installing LCD assembly.
  4. Install the LCD assembly as described in [Installing the LCD Display Assembly \(A11\) \(p. 325\)](#).
  5. Install the interface PCB as described in [Installing the Interface PCB \(A05\) \(p. 314\)](#).
  6. Reassemble the case as described in [Reassembling the Case \(p. 304\)](#).

### Front Case Replacement

Refer to [Inside Front Case Diagram \(p. 309\)](#)



Figure 10.20—Front case replacement (V2 unit shown)

### Disassembling the Front Case

Refer to [Figure 10.20 on p. 328](#).

- ◆ To disassemble the front case:
  1. Remove the printer assembly as described in [Removing the Printer Assembly \(A12\) \(p. 480\)](#).
  2. Separate the front and rear case halves as described in [Disassembling the Case \(p. 301\)](#).
  3. Perform steps 1 through 3 to disconnect cables as described in [Removing the Interface PCB \(A05\) \(p. 313\)](#). Note that J36 and J37 do not require removal.
  4. Remove the four LCD bracket mounting screws (202253-764) (see [Figure 10.18 on p. 324](#)). Discard the screws.
  5. Remove the printer control keypad cable from the back of the keypad as described in [Removing the Printer Control Keypad/Interface PCB Cable \(W12\) \(p. 336\)](#).
  6. Remove the main keypad cable from the back of the keypad as described in [Removing the Main Keypad/Interface PCB Cable \(W13\) \(p. 337\)](#).
  7. Remove the speed dial assembly as described in [Removing the Speed Dial Assembly \(W15\) \(p. 338\)](#).
  8. Remove the speaker assembly as described in [Removing the Speaker Assembly \(W17\) \(p. 344\)](#).
  9. Remove the therapy connector cable as described in [Removing the Therapy Connector Cable \(W11\) \(p. 334\)](#).
  10. Remove the printer assembly/interface PCB Cable (includes removal of the W19 cable) as described in [Removing the Printer Assembly/Interface PCB Cable \(W16\) \(p. 341\)](#).

### Assembling the Front Case

Refer to [Figure 10.20 on p. 328](#).

- ◆ To install the new front case: *15 steps, (Page 1 of 2)*

**NOTE:** Use the [Front Case Repair Kit \(MIN 3305431-023\)](#) (p. 628).

**NOTE:** Transfer the following parts from the old front case to the new front case:

- ~ LCD/interface PCB assembly
- ~ W15 speed dial assembly
- ~ W17 speaker assembly
- ~ W11 therapy connector
- ~ W16 printer/interface PCB cable
- ~ W12 printer control keypad cable
- ~ W13 main keypad cable
- ~ Printer bracket ([3006810-01](#)) with W19 cable

1. Install the perimeter seal ([804234-03](#)) into the groove on the front case.

**NOTE:** Thread the perimeter seal approximately 1.5 inches through the seal lock.  
Do not stretch the seal, as this will result in crimped corners.

2. Install the speed dial assembly as described in [Installing the Speed Dial Assembly \(W15\)](#) (p. 340).
3. Install the therapy connector cable as described in [Installing the Therapy Connector Cable \(W11\)](#) (p. 334).
4. Install the printer assembly/interface PCB Cable (includes the W19 cable) as described in [Installing the Printer Assembly/Interface PCB Cable \(W16\)](#) (p. 342).

- ◆ To install the new front case: *(Continued) 15 steps, (Page 2 of 2)*
  5. Install the speaker assembly as described in [Installing the Speaker Assembly \(W17\)](#) (p. 345).
  6. Install the display lens as described in [Installing the Display Lens](#) (p. 327).
  7. Install the display shield as described in [Installing the Display Lens Shield](#) (p. 323).
  8. Install the LCD/Interface PCB assembly by installing the LCD mounting bracket in the front case and secure with four new screws ([202253-764](#)); torque to 6.8 in-lb.
  9. Reconnect cables to interface PCB by performing step 3 as described in [Installing the Interface PCB \(A05\)](#) (p. 314).
  10. Install the printer control keypad as described in [Installing the Printer Control Keypad \(A09\)](#) (p. 319).
  11. Install the main keypad as described in [Installing the Main Keypad \(A10\)](#) (p. 321).
  12. Reassemble the case as described in [Reassembling the Case](#) (p. 304).
  13. Clean the front case with isopropyl alcohol, and apply Physio-Control logo ([3208003-000](#)) to the location provided in upper left of front case.
  14. Install the printer assembly as described in [Installing the Printer Assembly \(A12\)](#) (p. 481).
  15. Installing the label set ([3207318-XXX](#), see [Table 11.14 on page 544](#)) is required. Clean the front case areas with isopropyl alcohol and install label numbers 4, 6, 10 and 11.

### System/Interface PCB Cable (W04) Replacement

Refer to [Inside Front Case Diagram \(p. 309\)](#).

#### Removing the System/Interface PCB Cable (W04)

- ◆ To remove the system/interface PCB W04 cable (3206991-003) (see [Figure 10.11 on p. 311](#) and [Figure 11.44 on p. 585](#)) from the front case:

**NOTE:** Cable solder connections are fragile; keep handling to a minimum.

1. Disassemble the case as described in [Disassembling the Case \(p. 301\)](#). This procedure removes the W04 cable from the system PCB (A01) at J2.
2. Disconnect the W04 cable from the interface PCB at J30.

#### Installing the System/Interface PCB Cable (W04)

- ◆ To install the system/interface PCB W04 cable (3206991-003) (see [Figure 11.44 on p. 585](#)) into the front case:
  1. Snap connector of the System/Interface cable (W04) (3206991-003) over tabs and connect to interface PCB at J30. Check that connector is fully seated.
  2. Reassemble the case as described in [Reassembling the Case \(p. 304\)](#) to connect the W04 cable to the system PCB (A01) at J2.

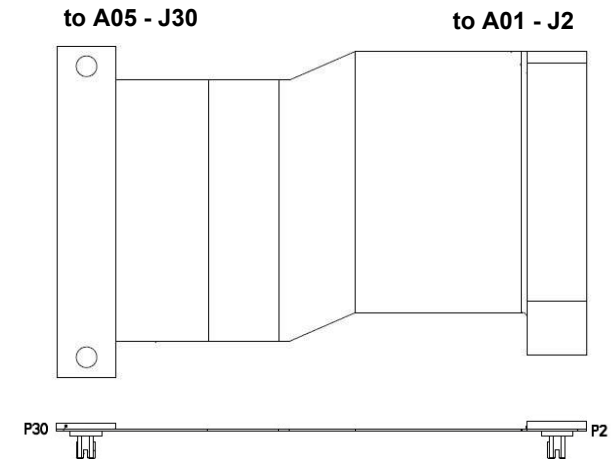

Figure 10.21—System/interface PCB cable connections



### Backlight/Interface PCB Cable (W06) Replacement

Refer to [Inside Front Case Diagram \(p. 309\)](#).

#### Removing the Backlight/interface PCB (W06) Cable

- ◆ To remove the backlight/interface W06 cable (3206992-000) (see [Figure 11.46 on p. 587](#)) from the front case:
  1. Disassemble the case as described in [Disassembling the Case \(p. 301\)](#).
  2. Press the connector locking tab and disconnect the W06 cable from the interface PCB at J37.
  3. Place even pressure on the cable and ease the W06 cable out of the connector on the Backlight PCB.

#### Installing the Backlight/interface PCB (W06) Cable

- ◆ To install the backlight/interface W06 cable into the front case:
  1. Connect the W06 cable (3206992-000) to the Backlight PCB.
  2. If interface PCB is present, connect the W06 cable to the interface PCB at J37.
  3. Reassemble the case as described in [Reassembling the Case \(p. 304\)](#).

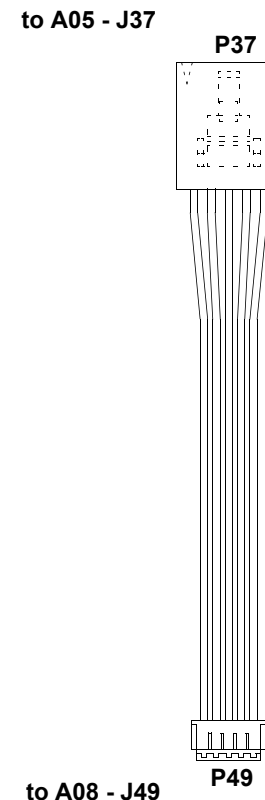

Figure 10.22—Backlight PCB/interface PCB cable connections

### Therapy Connector Cable (W11) Replacement

Refer to [Inside Front Case Diagram](#) (p. 309).

#### Removing the Therapy Connector Cable (W11)

- ◆ To remove the therapy connector cable (see [Figure 11.51](#) on p. 592) from the front case:
  1. Disassemble the case as described in [Disassembling the Case](#) (p. 301).
  2. From the outside of the front case, remove the four screws (3207361-375) from the therapy connector.
  3. Lift the therapy Connector cable (3207044-002) and therapy mounting seal from the front case. Discard the four screws and therapy mounting seal (3207701-000).

#### Installing the Therapy Connector Cable (W11)

- ◆ To install the therapy Connector cable into the front case:

*4 steps, (Page 1 of 2)*

**NOTE:** If therapy connector cable requires replacement, use the [Therapy Connector Repair Kit](#) (MIN 3305431-009) (p. 620).

1. From the outside of the front case, install a new therapy mounting seal (3207701-000) into the front case.

#### CAUTION

**POSSIBLE MOISTURE LEAKAGE** When installing the therapy connector, use a new therapy mounting seal (3207701-000) to help prevent ingress of fluids.

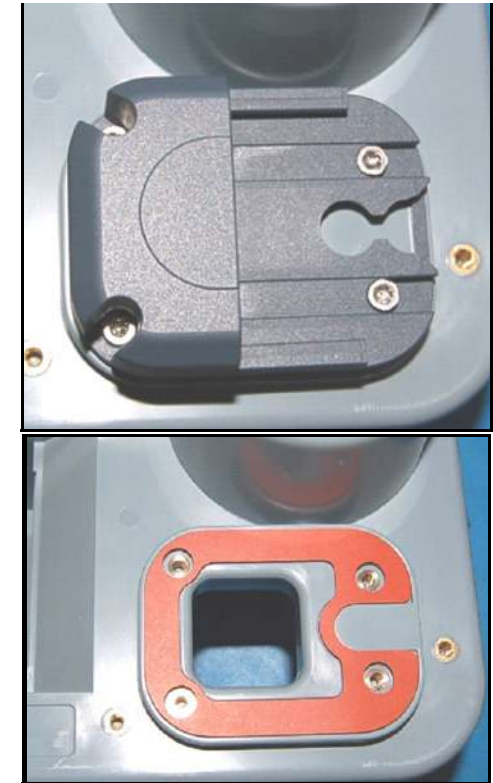

Figure 10.23—Therapy connector cable and seal

- ◆ To install the therapy Connector cable into the front case:

*(Continued) 4 steps, (Page 2 of 2)*

2. From the outside of the front case, insert the new therapy Connector cable through the therapy mounting seal and front case.
3. Secure the therapy connector to the front case with four new screws ([3207361-375](#)); torque to 10 in-lb using a T15 bit.
4. Reassemble the case as described in [Reassembling the Case \(p. 304\)](#).

### Printer Control Keypad/Interface PCB Cable (W12) Replacement

Refer to [Inside Front Case Diagram](#) (p. 309).

#### Removing the Printer Control Keypad/Interface PCB Cable (W12)

See diagram on [Figure 11.29](#) on p. 570.

- ◆ To remove the W12 cable ([3206989-000](#)) from the front case:
  1. Disassemble the case as described in [Disassembling the Case](#) (p. 301).
  2. Press the connector locking tab, and then disconnect the W12 cable from the interface PCB at J32.
  3. Press the connector locking tab, and then disconnect the W12 cable from the printer control keypad at J41.

#### Installing the Printer Control Keypad/Interface PCB Cable (W12)

- ◆ To install the W12 cable into the front case:
  1. Connect the W12 cable ([3206989-000](#)) to the printer control keypad at J41.
  2. If interface PCB is present, connect the W12 cable to the interface PCB at J32.
  3. Reassemble the case as described in [Reassembling the Case](#) (p. 304).

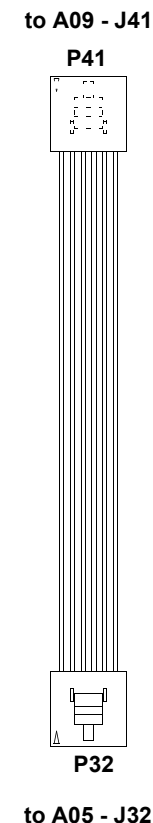

Figure 10.24—Printer control keypad/interface PCB cable connections

### Main Keypad/Interface PCB Cable (W13) Replacement

Refer to [Inside Front Case Diagram \(p. 309\)](#).

#### Removing the Main Keypad/Interface PCB Cable (W13)

- ◆ To remove the W13 cable ([3207388-001](#)) from the front case:
  1. Disassemble the case as described in [Disassembling the Case \(p. 301\)](#).
  2. Press the connector locking tabs to unlock the connector, and then disconnect the W13 cable from the interface PCB at J31.
  3. Press the connector locking tabs to unlock the connector, and then disconnect the W13 cable from the main keypad at J39.

#### Installing the Main Keypad/Interface PCB Cable (W13)

- ◆ To install the W13 cable ([3207388-001](#)) into the front case:
  1. Connect the W13 cable to the main keypad at J39 (“snap” the connector locking tabs into the locked position).
  2. If interface PCB is present, connect the W13 cable to the interface PCB at J31 (“snap” the connector locking tabs into the locked position).
  3. Reassemble the case as described in [Reassembling the Case \(p. 304\)](#).

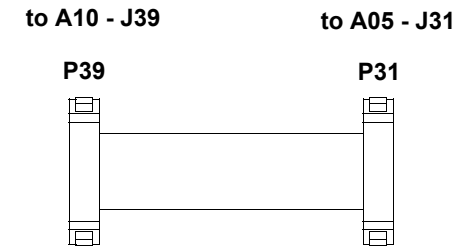

Figure 10.25—Main keypad/interface PCB cable connections

### Speed Dial Assembly (W15) Replacement:

#### Removing the Speed Dial Assembly (W15)

- ◆ To remove the speed dial assembly (3011128-002) (see [Figure 11.54](#) on [p. 595](#)) from the front case: *5 steps, (Page 1 of 2)*
  1. Disassemble the case as described in [Disassembling the Case](#) (p. 301).
  2. Press the connector locking tab, and then disconnect the speed dial assembly cable from the interface PCB at J33.
  3. From the outside of the front case, grasp the speed dial assembly knob (3207030-000) and, with steady smooth force, pull the knob off the speed dial assembly shaft. Use a gripping tool if necessary, taking care to avoid any damage.

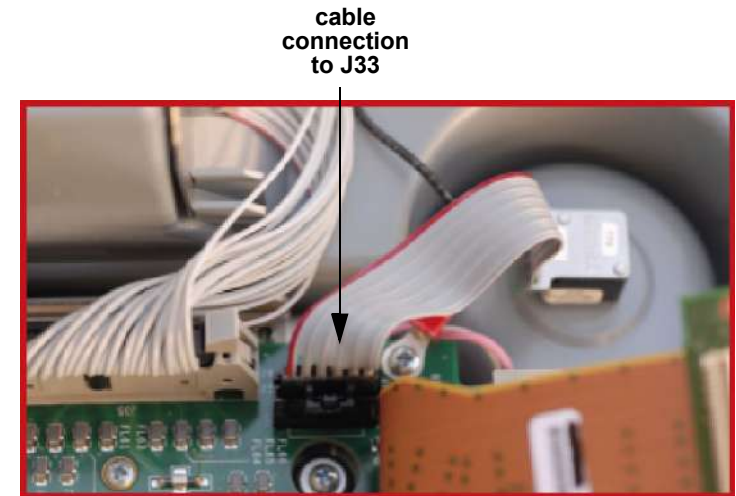

Figure 10.26—Speed dial cable

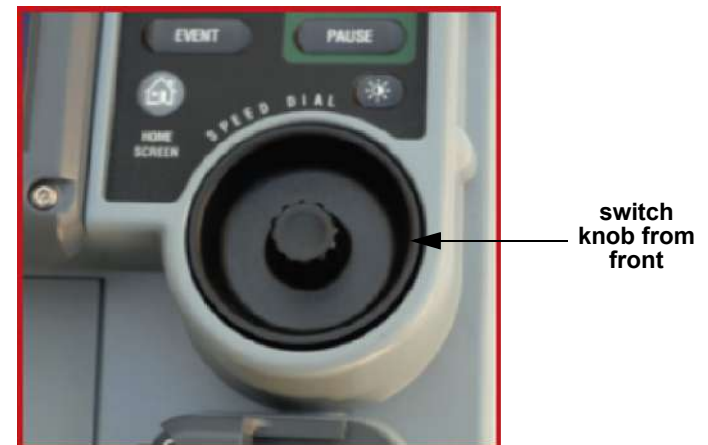

Figure 10.26—Speed dial knob

- ◆ To remove the speed dial assembly (3011128-002) (see [Figure 11.54](#) on [p. 595](#)) from the front case: *(Continued) 5 steps, (Page 2 of 2)*
  4. From the outside of the case, loosen and remove the nut and lock washer (part of the speed dial assembly) from the speed dial assembly shaft.
  5. From the inside of the case, pull the speed dial assembly away from the case and remove it.

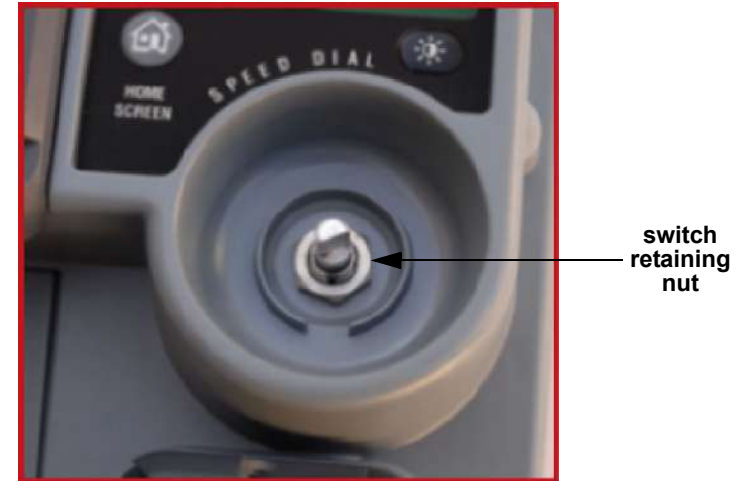

Figure 10.27—Nut and lock washer

### Installing the Speed Dial Assembly (W15)

- ◆ To install the speed dial assembly into the front case ([Inside Front Case Diagram \(p. 309\)](#)):

**NOTE:** When installing a new speed dial assembly (3011128-002) use [External Hardware Repair Kit \(MIN 3305431-016\) \(p. 624\)](#).

1. Insert the speed dial assembly from inside the front case so that the cable is extending away from the perimeter seal.
2. Attach the speed dial assembly shaft to the front case with the nut and lock washer (torque to 10 in-lb using a 9/16 deep socket).
3. Push the knob (3207030-000) onto the speed dial assembly shaft from the outside of the front case (see [Figure 10.27 on p. 339](#)).
4. If interface PCB is present, connect the speed dial assembly to the interface PCB at J33.
5. Reassemble the case as described in [Reassembling the Case \(p. 304\)](#).

rear of switch, orient with  
cable toward PCB

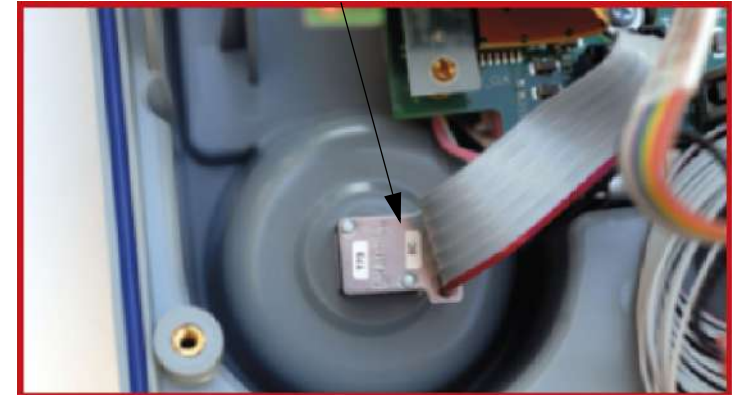

Figure 10.28—Speed dial assembly

cable connection  
to J33

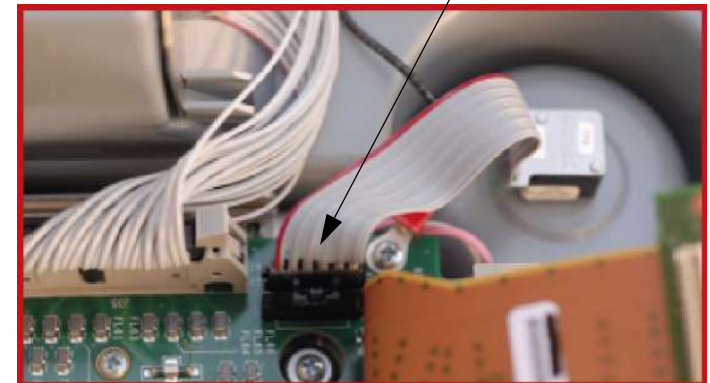

Figure 10.29—Speed dial cable



### Printer Assembly/Interface PCB Cable (W16) Replacement

Refer to [Inside Front Case Diagram \(p. 309\)](#).

#### Removing the Printer Assembly/Interface PCB Cable (W16)

- ◆ To remove the printer/interface PCB cable (3009724-001) (see [Figure 11.56 on p. 597](#)) from the front case:
  1. Disassemble the case as described in [Disassembling the Case \(p. 301\)](#).
  2. Spread the connector locking tabs and eject the W16 cable from the A05 interface PCB at J35.
  3. Disconnect the W19 cable ground terminal from the printer assembly connector bracket.
  4. Remove the retaining screw (3207337-312) and connector bracket (3006810-01) on the A12 printer assembly housing that secures the W16 cable at P40. Discard the screw.
  5. With a flat edged tool, gently pry the W16 cable at P40 out of the J40 connector on the printer assembly. Remove and discard the rubber moisture gasket (3006809-00).

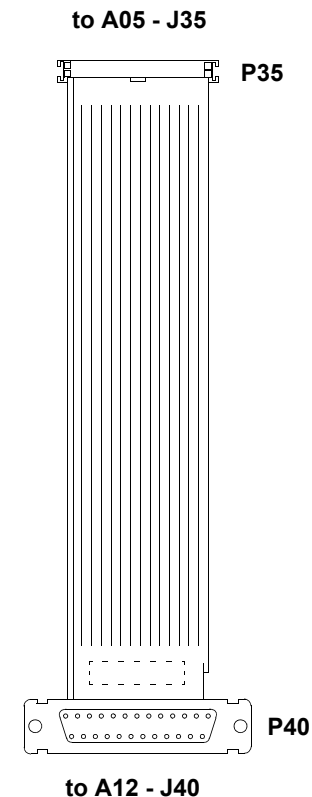

Figure 10.30—Printer / Interface PCB connection

### Installing the Printer Assembly/Interface PCB Cable (W16)

Refer to [Figure 10.30 on p. 341](#).

◆ To install the printer/interface PCB cable (W16) into the front case:

**NOTE:** When installing printer/interface PCB cable ([3009724-001](#)) use [External Hardware Repair Kit \(MIN 3305431-016\)](#) (p. [624](#)).

1. Install a new rubber moisture gasket ([3006809-00](#)) onto the W16 cable. Connect the W16 cable to the printer assembly at J40. Place the printer assembly connector bracket ([3006810-01](#)) over the printer W16 cable and secure it with one new screw with washer ([3207337-312](#)) into the front case; torque to 6.8 in-lb.
2. Connect the W19 cable ground terminal ([3009726-03](#)) to the printer assembly connector bracket.
3. If interface PCB is present, connect the W16 cable to the interface PCB at J35.
4. Reassemble the case as described in [Reassembling the Case](#) (p. [304](#)).

### Speaker Assembly (W17) Replacement

Refer to [Inside Front Case Diagram \(p. 309\)](#).

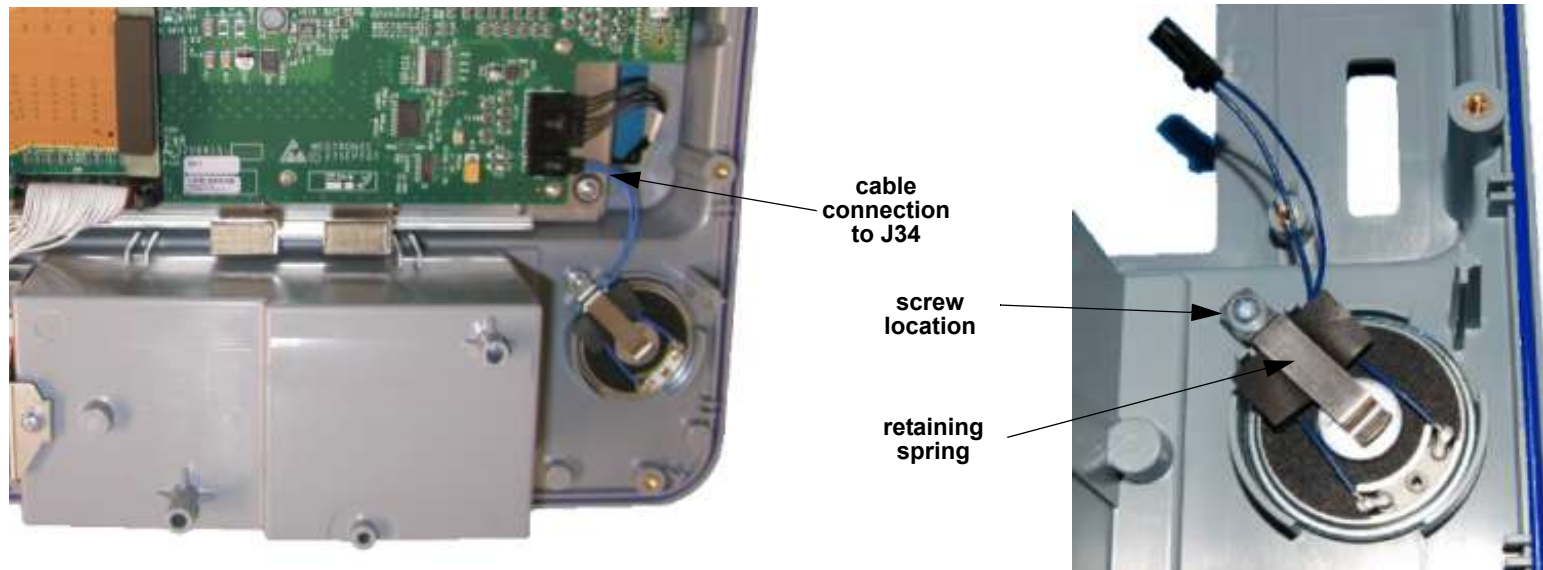
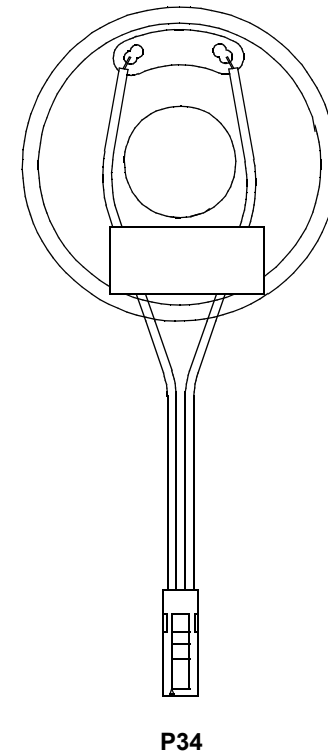

Figure 10.31—Speaker assembly replacement cable connection and screw location

### Removing the Speaker Assembly (W17)

Refer to [Figure 10.31 on p. 343](#).

- ◆ To remove the Speaker Assembly (3009726-03) (see [Figure 11.57 on p. 598](#)) from the front case:
  1. Disassemble the case as described in [Disassembling the Case \(p. 301\)](#).
  2. Press the connector locking tab, and then disconnect the Speaker Assembly from the interface PCB at J34, if the interface PCB is present.
  3. Remove the screw ([3207337-312](#)) securing the spring clamp ([3012693-00](#)) for the W17 Speaker Assembly. Note the orientation of the spring clamp for reassembly. Discard the screw.
  4. Set the spring clamp aside, and then lift the Speaker Assembly from the front case.



**Figure 10.32—Speaker  
Assembly connection**

### Installing the Speaker Assembly (W17)

Refer to [Figure 10.31 on p. 343](#).

◆ To install the Speaker Assembly into the front case ([Inside Front Case Diagram \(p. 309\)](#)):

**NOTE:** When installing speaker assembly (3009726-03) use [External Hardware Repair Kit \(MIN 3305431-016\) \(p. 624\)](#).

1. Set the Speaker Assembly into the case and secure the spring clamp (3012693-00) with one new screw with washer (3207337-312); torque to 6.8 in-lb.

**NOTE:** Make sure you do not pinch the wires during reassembly.

#### CAUTION

**POSSIBLE MOISTURE LEAKAGE** When installing the Speaker Assembly, make sure the speaker felt moisture barrier is in place on the front case to help prevent ingress of fluids. When replacing the speaker, do not touch the speaker felt.

2. If interface PCB is present, connect the Speaker Assembly to the interface PCB at J34.
3. Reassemble the case as described in [Reassembling the Case \(p. 304\)](#).

### LCD Display Assembly/Interface PCB Cable (W18) Replacement

Refer to [Inside Front Case Diagram \(p. 309\)](#).

#### Removing the LCD Display Assembly/Interface PCB Cable (W18)

- ◆ To remove the LCD display/interface PCB W18 cable ([3206990-001](#)) from the front case:
  1. Disassemble the case as described in [Disassembling the Case \(p. 301\)](#).
  2. Remove the W18 cable ([3206990-001](#)) (see [Figure 11.58 on p. 599](#)) from the interface PCB at J36.
  3. Place even pressure on the cable ribbon and ease the W18 cable out of the connector on the LCD display assembly.

#### Installing the LCD Display Assembly/Interface PCB Cable (W18)

- ◆ To install the LCD display/interface PCB W18 cable ([3206990-001](#)) into the front case:
  1. Connect the W18 cable to the connector on the LCD display assembly.
  2. If interface PCB is present, connect the W18 cable to the interface PCB at J36.
  3. Reassemble the case as described in [Reassembling the Case \(p. 304\)](#).

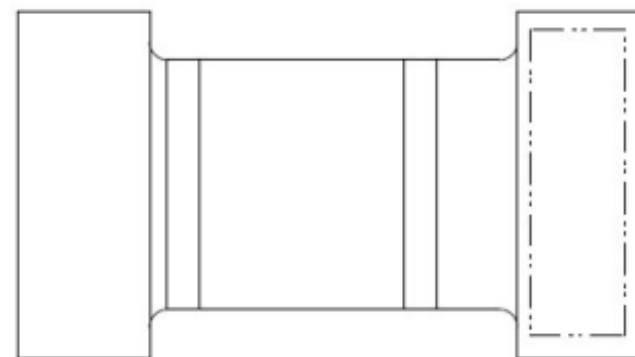

Figure 10.33—LCD cable connection

### Printer Assembly/Chassis Ground Cable (W19) Replacement

Refer to [Inside Front Case Diagram \(p. 309\)](#).

#### Removing the Printer Assembly/Chassis Ground Cable (W19)

- ◆ To remove the printer/chassis ground W19 cable ([3009726-01](#)) (see [Figure 11.59 on p. 600](#)) from the front case:
  1. Disassemble the case as described in [Disassembling the Case \(p. 301\)](#).
  2. Remove the screw ([202253-761](#)) securing the W19 cable to the interface PCB and LCD display assembly bracket ([3006810-01](#)). Discard the screw.
  3. Disconnect the W19 cable ground terminal from the printer assembly connector bracket.

#### Installing the Printer Assembly/Chassis Ground Cable (W19)

- ◆ To install the printer/chassis ground W19 cable ([3009726-01](#)) into the front case:
  1. Connect the W19 cable ground terminal to the printer assembly connector bracket.
  2. Secure the W19 cable to the interface PCB and LCD display assembly bracket ([3006810-01](#)) with one new screw ([202253-761](#)); torque to 6.8 in-lb.
  3. Reassemble the case as described in [Reassembling the Case \(p. 304\)](#).

chassis ground

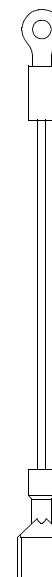

Printer Assembly (A12)

Figure 10.34—printer cable connection

### Inside Rear Case Diagrams

The inside rear case diagrams include the following:

- [Rear Case Overview \(p. 349\)](#)
- [System \(A01\)/Therapy \(A04\) PCBs Removed \(p. 350\)](#)
- [Energy Transfer Detail Diagram \(p. 351\)](#)

Numerous repair procedures refer to these diagrams.



### Rear Case Overview

Use this diagram after disassembling the case as described in [Disassembling the Case \(p. 301\)](#).

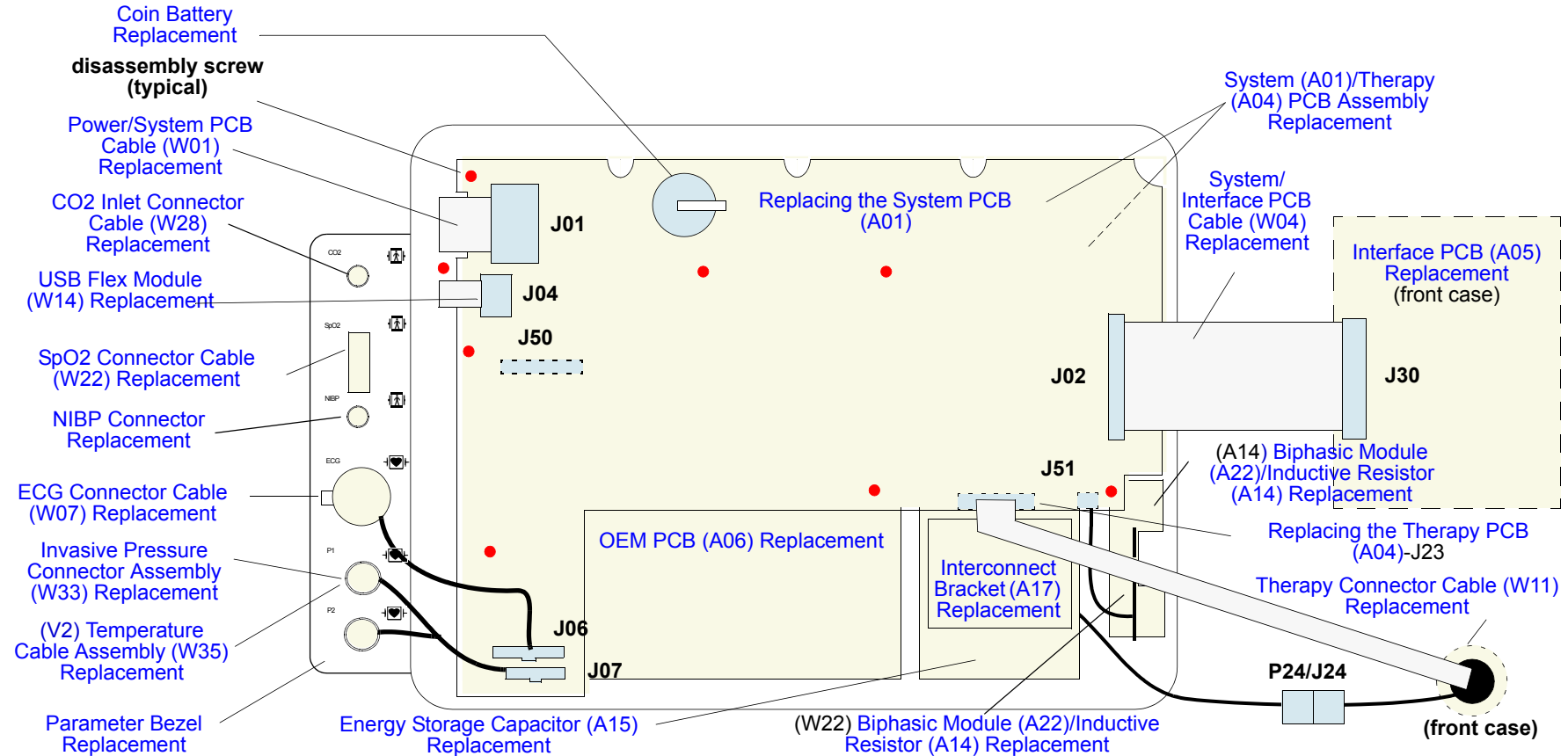

### System (A01)/Therapy (A04) PCBs Removed

Use this diagram after removing the A01 system and A04 therapy PCBs as described in [System \(A01\)/Therapy \(A04\) PCB Assembly Replacement](#) (p. 352).

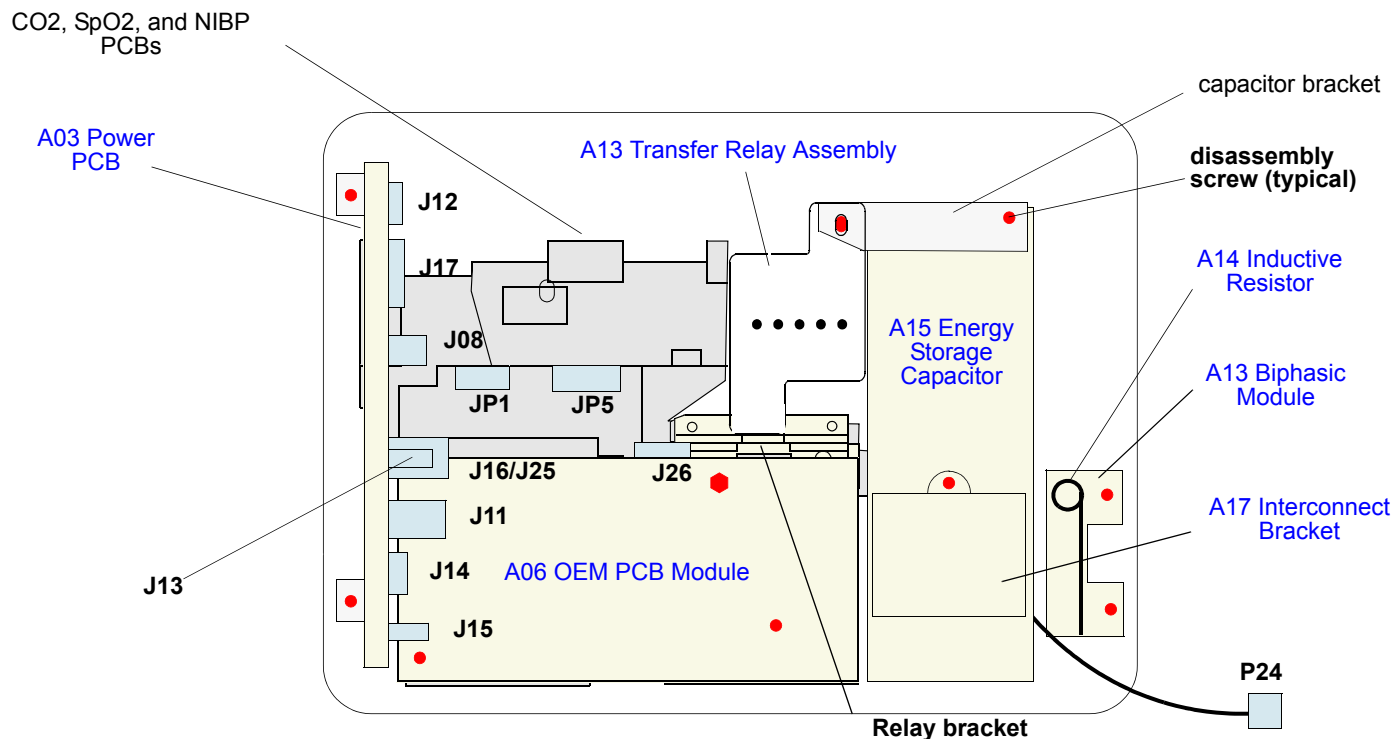

### Energy Transfer Detail Diagram

Use this diagram to replace the transfer relay assembly, biphasic module/inductive resistor, energy storage capacitor, and A17 interconnect bracket.

**Table 10.1—Interconnect bracket**

A17 Interconnect Bracket Chart	
Capacitor Neg 1	A17 Pin 1
Capacitor Pos 4	A17 Pin 4
A22 Biphasic J101	A17 Pin 3
A22 Biphasic J105	A17 Pin 6
A22 Biphasic J103	A17 Pin 9
Relay A1 (7)	A17 Pin 7
Relay B1 (104)	A22 BTE J104

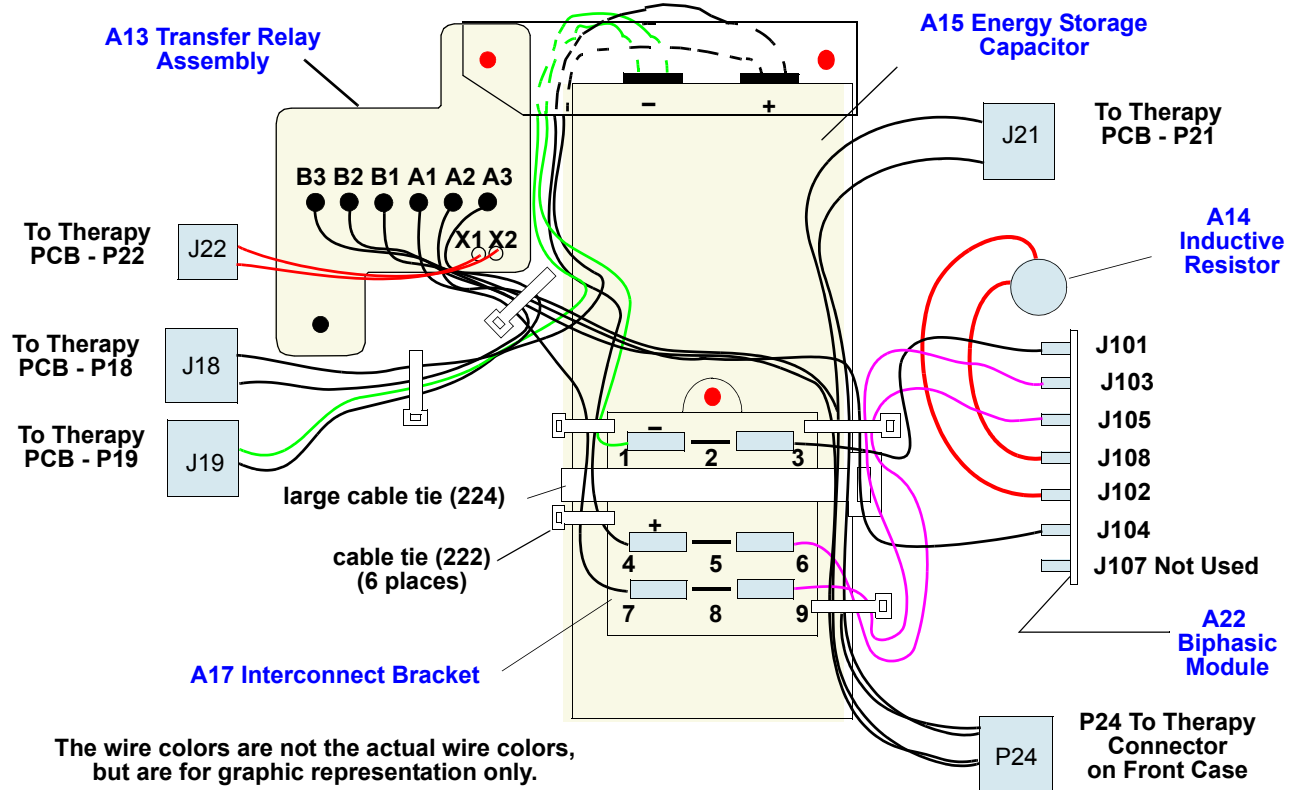

### System (A01)/Therapy (A04) PCB Assembly Replacement

The system/therapy PCB assembly is removed as a unit and then separated. Refer to [System/Therapy PCB Assembly Diagrams and Parts List \(p. 507\)](#) and [Figure 11.9 \(p. 508\)](#) for diagrams of this assembly. See [Figure 11.24 on p. 565](#) for a connection diagram of the therapy PCB and [Figure 11.22 on p. 563](#) for a connection diagram of the system PCB.

Replacement consists of the following procedures:

- [Removing the System \(A01\)/Therapy \(A04\) PCB Assembly \(p. 353\)](#)
- [Separating the System PCB \(A01\) \(p. 364\)](#)
- [Replacing the System PCB \(A01\) \(p. 366\)](#)
- [Separating the Therapy PCB \(A04\) \(p. 367\)](#)
- [Replacing the Therapy PCB \(A04\) \(p. 370\)](#)
- [Installing the System \(A01\)/Therapy \(A04\) PCB Assembly \(p. 359\)](#)

### Removing the System (A01)/Therapy (A04) PCB Assembly

◆ To remove the system/therapy PCBs as a single unit from the rear case: *9 steps, (Page 1 of 6)*

1. Disassemble the case as described in [Disassembling the Case \(p. 301\)](#).
2. Disconnect the connectors on the system PCB as follows:
  - ~ J1 – Press the connector locking tabs and disconnect the power/system PCB cable (W01, [3207692-000](#)).
  - ~ J2 – (The system/interface PCB cable was disconnected during case disassembly ([Disassembling the Case \(p. 301\)](#))).
  - ~ J4 – Disconnect the USB flex connector (W14, [3206966-001](#)).
  - ~ J6 – Disconnect the ECG connector cable (W7, [3007991-007](#)).
  - ~ (If present) J7 – Disconnect the IP connector of the IP wire harness (W33, [3200466-01](#)).
  - ~ (If present) J7 – Disconnect the temperature connector of the temperature cable (W35, [3303936-001](#)).

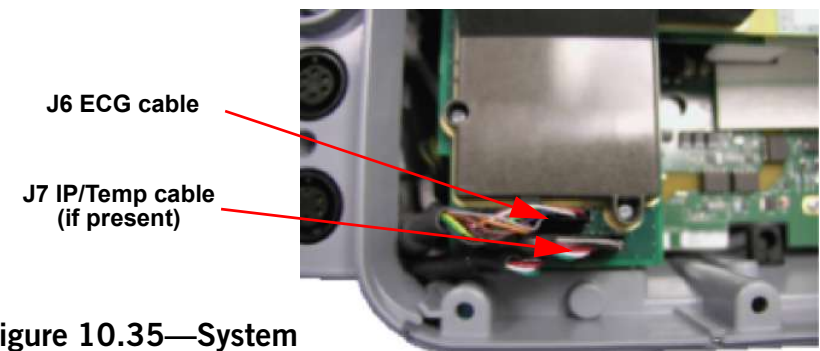
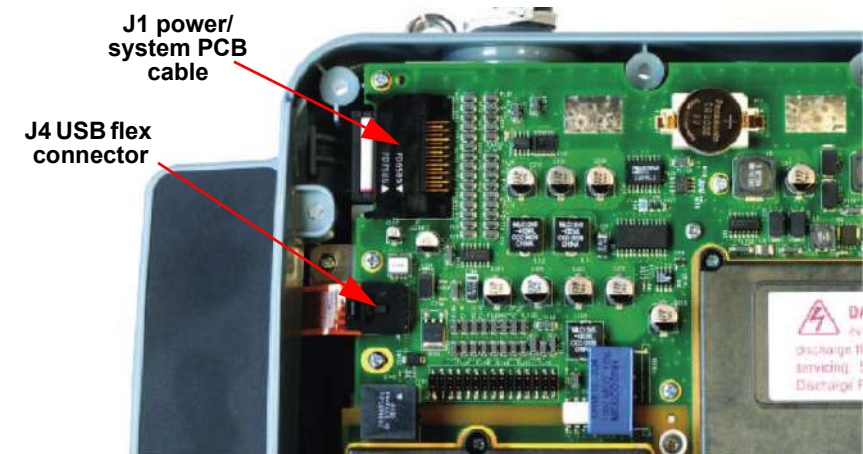

Figure 10.35—System PCB connectors

◆ To remove the system/therapy PCBs as a single unit from the rear case: *(Continued) 9 steps, (Page 2 of 6)*

~ J106 (A22 biphasic PCB) - Disconnect the BTE cable from the biphasic PCB (W20, [3011792-005](#)).

**NOTE:** The 3011792 BTE to therapy PCB cable is used as the replacement cable after the release of LIFEPAK15 V2.

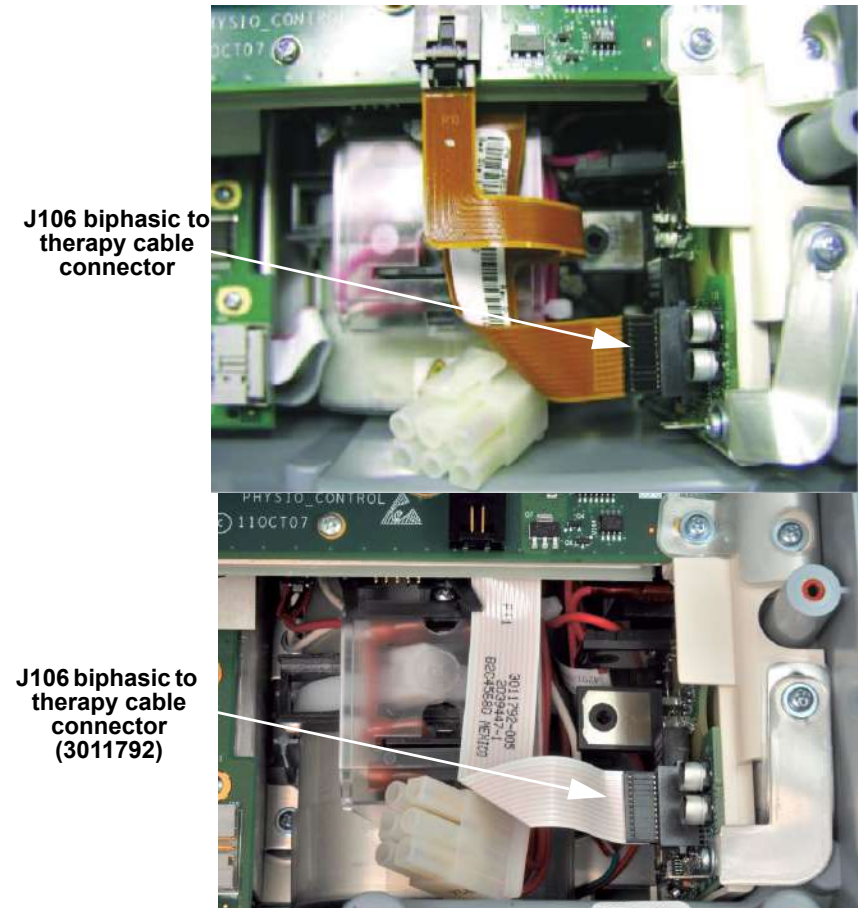

Figure 10.36—W20 biphasic cable



- ◆ To remove the system/therapy PCBs as a single unit from the rear case: *(Continued) 9 steps, (Page 3 of 6)*
  3. Remove the seven screws (202253-761) and one screw with washer (3207337-312) that secure the system PCB to the rear case. Discard the screws.  
**NOTE:** The screw that is in the ECG shield can easily be missed as part of screw removal. Ensure that all screws are removed prior to lifting the system/therapy PCB assembly.
  4. Set the rear case upright and move the system/therapy PCB assembly towards the front of the case to gain access to the rear therapy PCB connectors.

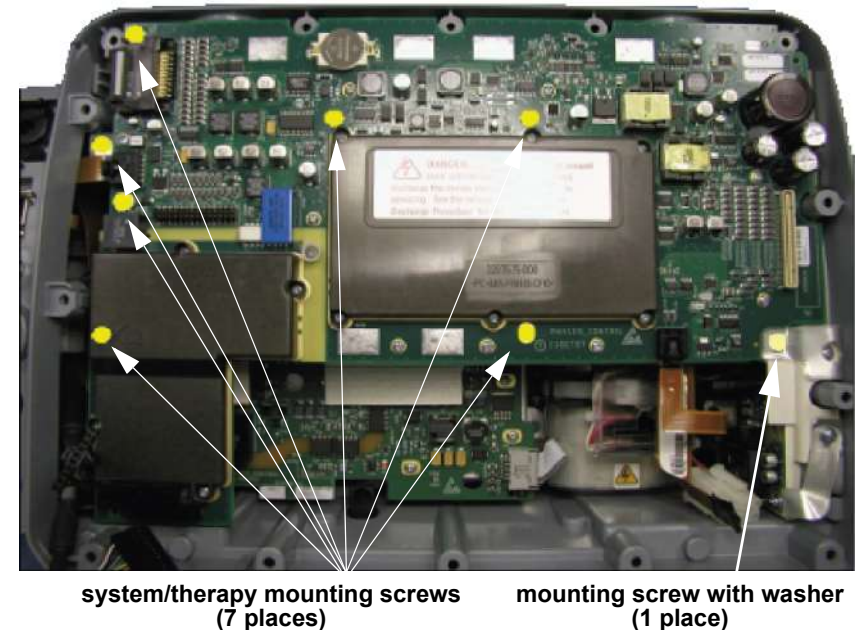
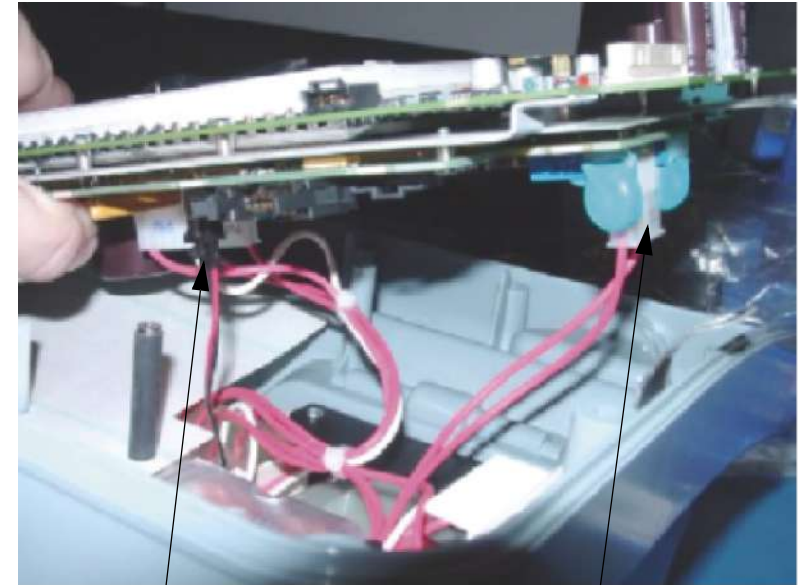

Figure 10.37—System/therapy PCB screw locations

- ◆ To remove the system/therapy PCBs as a single unit from the rear case: *(Continued) 9 steps, (Page 4 of 6)*
  5. Disconnect the transfer relay (3201583-001) from the therapy PCB at J22.
  6. Disconnect the transfer relay (3201583-001) from the therapy PCB at J21.



J22 transfer relay

J21 transfer relay

Figure 10.38—System/therapy PCB cable connections



- ◆ To remove the system/therapy PCBs as a single unit from the rear case: *(Continued) 9 steps, (Page 5 of 6)*
  7. Continue lifting the assembly. Disconnect the following connectors on the therapy PCB in the following order:
    - ~ J18 – Disconnect transfer relay assembly connector (A13, [3201583-001](#)).
    - ~ J19 – Disconnect energy storage capacitor connector (A15, [3008164-002](#)).
    - ~ J20 – Disconnect power/PCB therapy cable (W02, [3009726-05](#)).

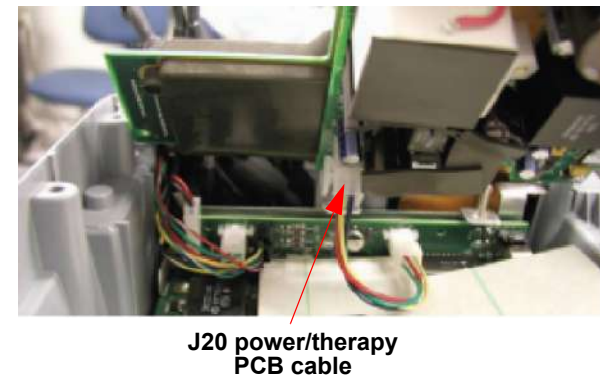
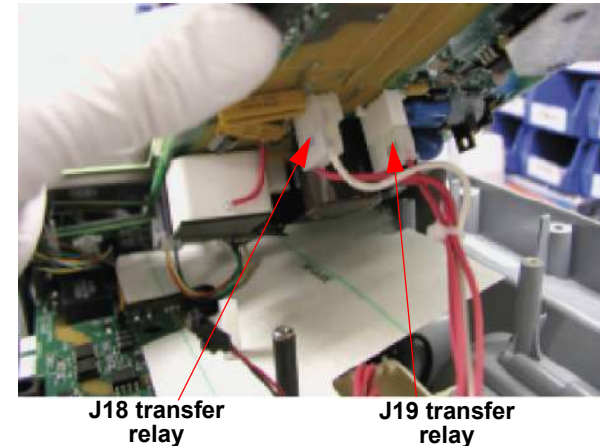

Figure 10.39—System/therapy PCB cable connections

- ◆ To remove the system/therapy PCBs as a single unit from the rear case: *(Continued) 9 steps, (Page 6 of 6)*
  8. Lift the system/therapy board assembly out from the rear case.  
Turn the system/therapy board assembly over to expose the therapy board.
  9. Immediately discharge the pacing capacitor as described in [Discharging the C15 Pacing Capacitor \(p. 299\)](#). The discharge points are located at resistors R5 and R20 on the therapy board.

### Installing the System (A01)/Therapy (A04) PCB Assembly

- ◆ To install the system/therapy PCB: *15 steps, (Page 1 of 5)*
  1. Line up the system/therapy assembly with rear case.
  2. Connect the W14 - USB flex cable ([3206966-001](#)) to J4 of the system PCB.
  3. Connect the W01 - power/system cable to J1 of system PCB.
  4. Connect the W02 - power/therapy cable from the power PCB P20 ([3009726-05](#)) to J20 of the therapy PCB.

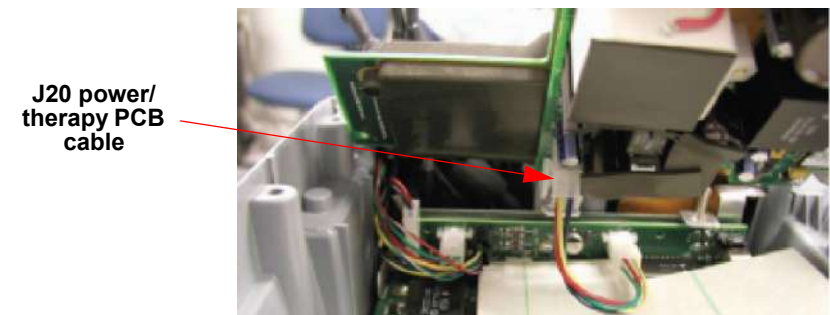
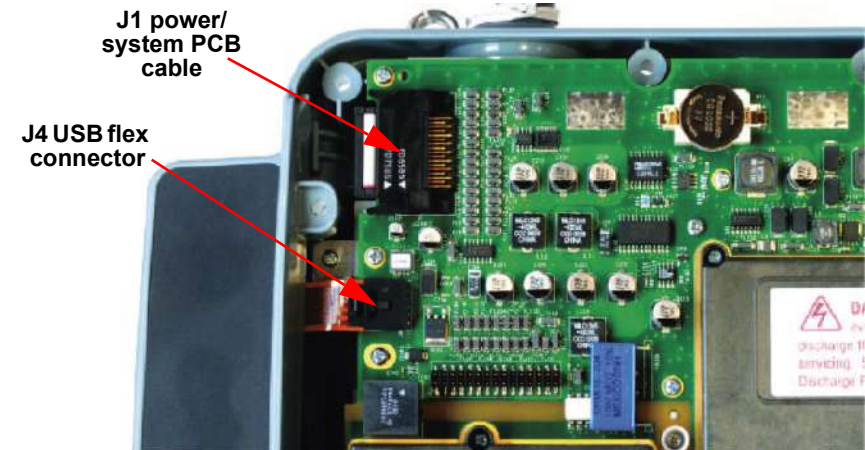

Figure 10.40—System/therapy PCB connections

- ◆ To install the system/therapy PCB: *(Continued) 15 steps, (Page 2 of 5)*
  5. Connect the 5-pin connector from the A13 - transfer relay P18 to J18 of the therapy PCB.
  6. Connect the 5-pin connector from the A15 - energy capacitor to J19 of the therapy PCB.
  7. Connect the 5-pin connector from the A13 - transfer relay P21 to J21 of the therapy PCB.
  8. Connect the 2-pin connector (red and black wires) from the A13 - transfer relay to J22 of the therapy PCB.

### WARNING

**POSSIBLE INABILITY TO DELIVER THERAPY** Visually inspect to ensure that P22 is fully inserted into the J22 connector.

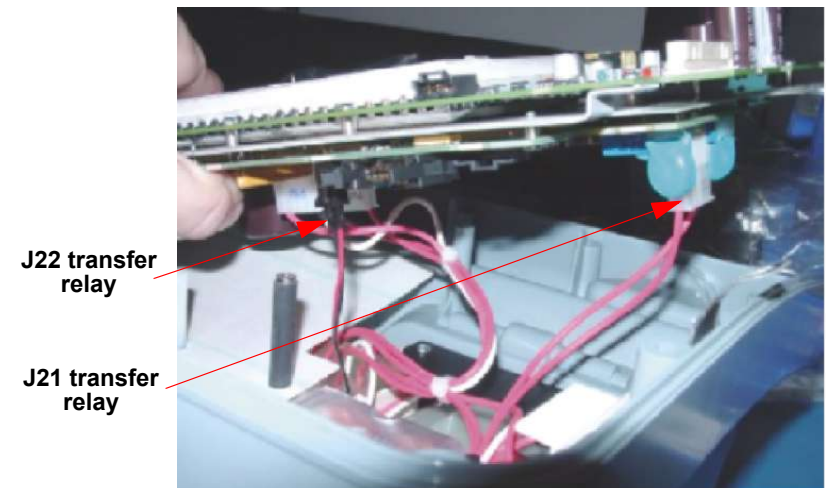
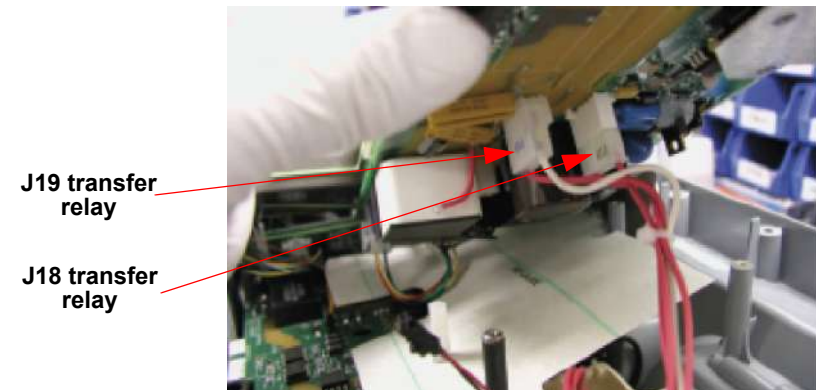

Figure 10.41—System/therapy PCB cable connections

- ◆ To install the system/therapy PCB: *(Continued) 15 steps, (Page 3 of 5)*
  9. Connect the W20 - BTE cable to the biphasic PCB at J106.

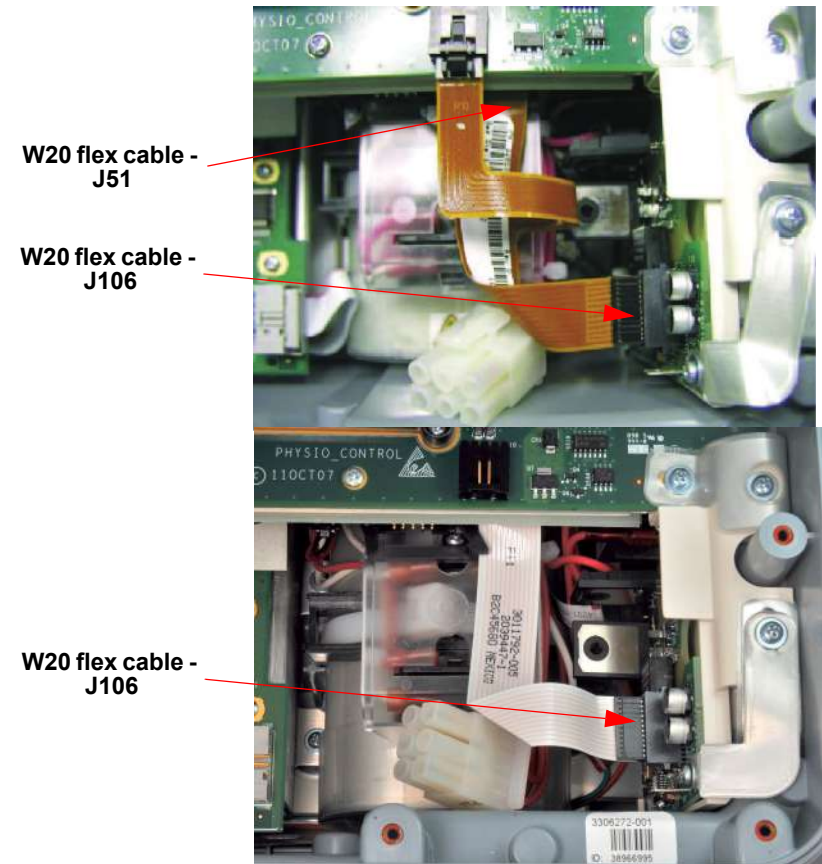
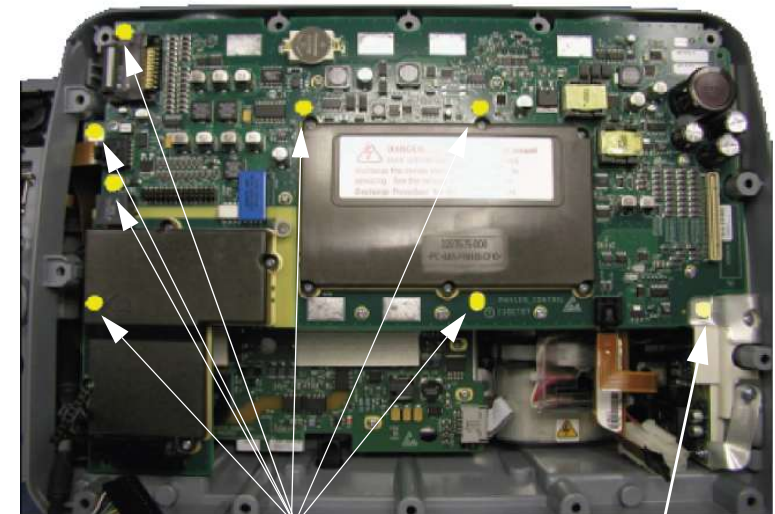

Figure 10.42—W20 flex cable connections



- ◆ To install the system/therapy PCB: *(Continued) 15 steps, (Page 4 of 5)*
  10. Line up the system PCB with the inserts in the rear case, and secure with seven new screws (202253-761); torque to 6.8 in-lb.
  11. Capture the ground strap from the EMI Shield with one new screw with washer (3207337-312); torque to 6.8 in-lb.



system/therapy mounting screws (7 places)    mounting screw with washer (1 place)

Figure 10.43—System PCB screws

◆ To install the system/therapy PCB: *(Continued) 15 steps, (Page 5 of 5)*

12. Connect the W07 - ECG cable from the parameter bezel to J6 of the system PCB.
13. If present, connect the W33 - IP cable from the parameter bezel to J7 of the system PCB.
14. If present, connect the W35 - temperature cable from the parameter bezel to J7 of the system PCB.

**NOTE:** Route wires, ECG behind the connector and IP/Temp in front of connector to reduce possible cable pinch with the front case.

**NOTE:** The screw in the ECG shield can be mispositioned. Check to ensure that the screw is installed and torqued.

15. Reassemble the case as described in [Reassembling the Case \(p. 304\)](#).

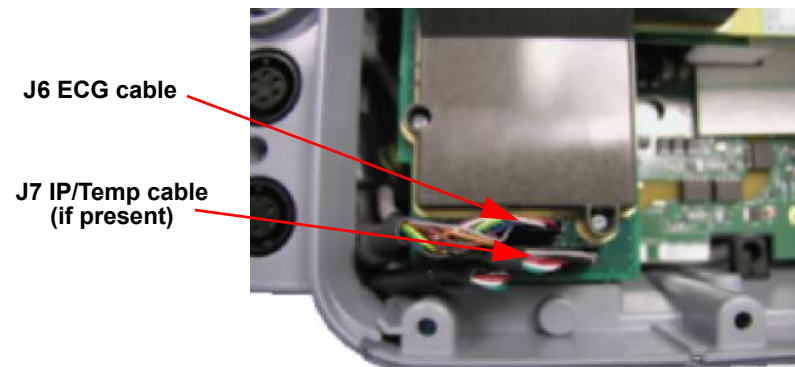

Figure 10.44—ECG and IP/Temp connections

### Separating the System PCB (A01)

- ◆ To separate the system PCB (A01) from the therapy PCB (A04): *6 steps, (Page 1 of 2)*
  1. Disassemble the case as described in [Disassembling the Case \(p. 301\)](#).
  2. Remove the system/therapy PCBs as a unit as described in [Removing the System \(A01\)/Therapy \(A04\) PCB Assembly \(p. 353\)](#).
  3. If the BTE cable (W20) is the three connector type, disconnect the BTE cable at the P10 connector from the system PCB assembly.

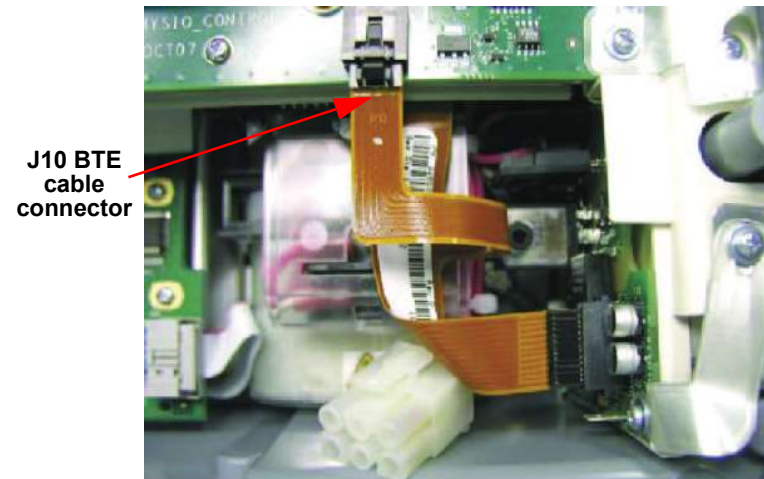

Figure 10.45—BTE cable connection (V1 cable, three connector type)



◆ To separate the system PCB (A01) from the therapy PCB (A04): *(Continued) 6 steps, (Page 2 of 2)*

4. Place the system/therapy PCB assembly with the system PCB (3206834) face up on your work surface. Remove the ten screws (202253-761). Discard the screws.
5. Remove the mounting screw (202253-550) from the insert hex nut (3011629-00). Remove the screw, spacer and insert hex nut from the assembly. Discard the screw.
6. Gently lift the system PCB up and away from the therapy PCB. The two PCBs are linked by the 30-pin header, which is a direct-connection contact assembly.

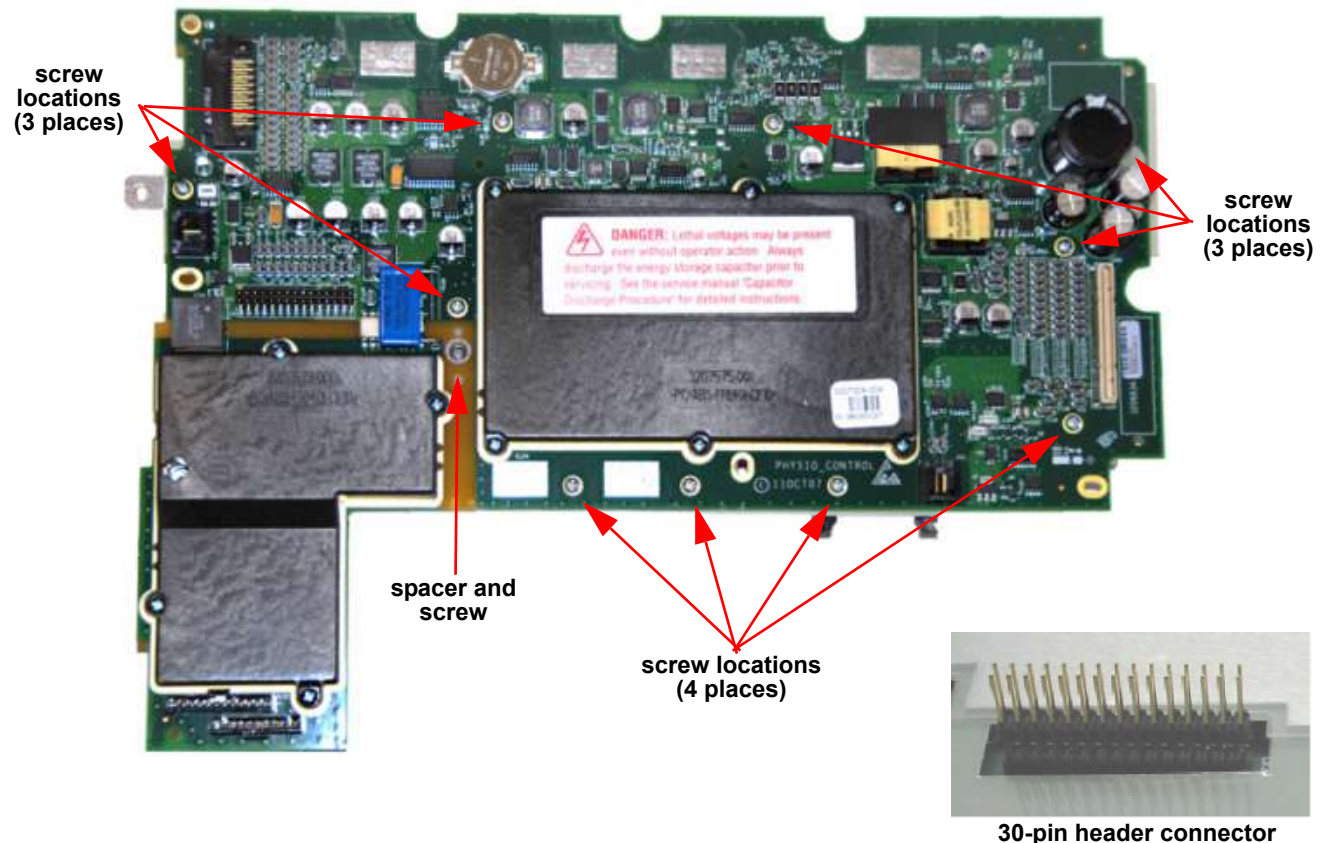

Figure 10.46—System/therapy PCB screw locations

### Replacing the System PCB (A01)

◆ To replace the system PCB (A01):

**NOTE:** When replacing the System PCB, use [System PCBA Repair Kit, V1 \(MIN 3305431-007\)](#) (p. 618).

1. Place therapy PCB facedown with the system/therapy mounting bracket installed.
2. Verify that the 30 pin header has no bent pins, and insert the 30 pin header ([3009878-002](#)) into the J50 circuit side of the therapy PCB.
3. Place the spacer ([3011630-00](#)) through hole in mounting bracket (see [Figure 11.8 on p. 507](#)).
4. Align the system PCB ([3206834](#)) with the mounting bracket and 30 pin header into J5. Fasten with ten new screws ([202253-761](#)); torque to 6.8 in-lb (see [Figure 10.46 on p. 365](#)).
5. Place the second spacer ([3011630-00](#)) through the hole in A01 system PCB. Insert new screw ([202253-550](#)) through the spacer stack and into the plastic insert hex nut ([3011630-00](#)). Hold nut with 3/8" nutdriver and tighten screw to 6.8 in-lb.
6. If the BTE cable (W20) is the three connector type, connect the BTE cable at the P10 connector to the system PCB assembly.
7. Follow the instructions to install the system/therapy assembly into device as described in [Installing the System \(A01\)/Therapy \(A04\) PCB Assembly](#) (p. 359).
8. After device reassembly, complete the TCP – Defibrillator Calibration procedure (see [TCP – Defibrillator Energy Calibration](#) (p. 200)). The defibrillator calibration constants may be invalidated when you replace System PCB.

### Separating the Therapy PCB (A04)

◆ To remove the therapy PCB (A04): *9 steps, (Page 1 of 3)*

1. Disassemble the case as described in [Disassembling the Case \(p. 301\)](#).
2. Remove the system/therapy assembly as described in [Removing the System \(A01\)/Therapy \(A04\) PCB Assembly \(p. 353\)](#).
3. Disconnect the BTE cable (W20) at the P51 connector from the therapy PCB assembly.

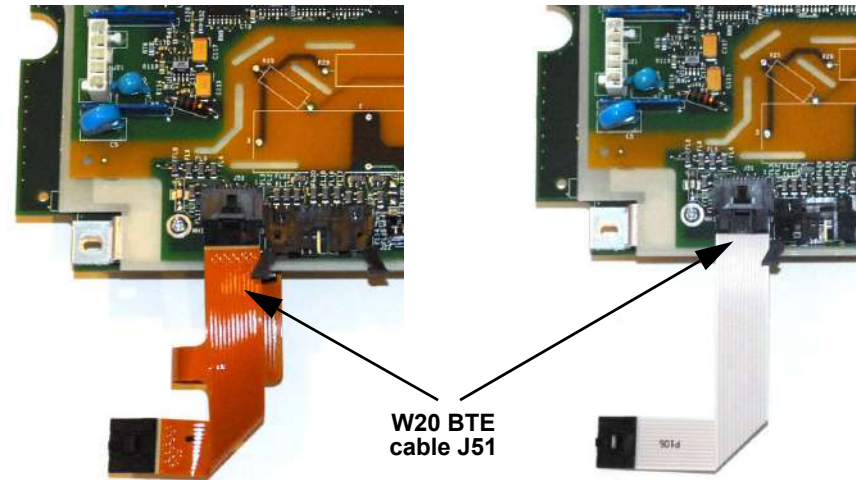

Figure 10.47—P51 therapy PCB connection

◆ To remove the therapy PCB (A04): *(Continued) 9 steps, (Page 2 of 3)*

4. Place the system/therapy PCB assembly with the therapy PCB face up. Remove the six screws (202253-761). Discard the screws.
5. Remove the mounting screw (202253-550) and spacer (3011630-00) from the insert nut (3011629-00). Set aside spacer and insert nut. Discard the screw (202253-550).

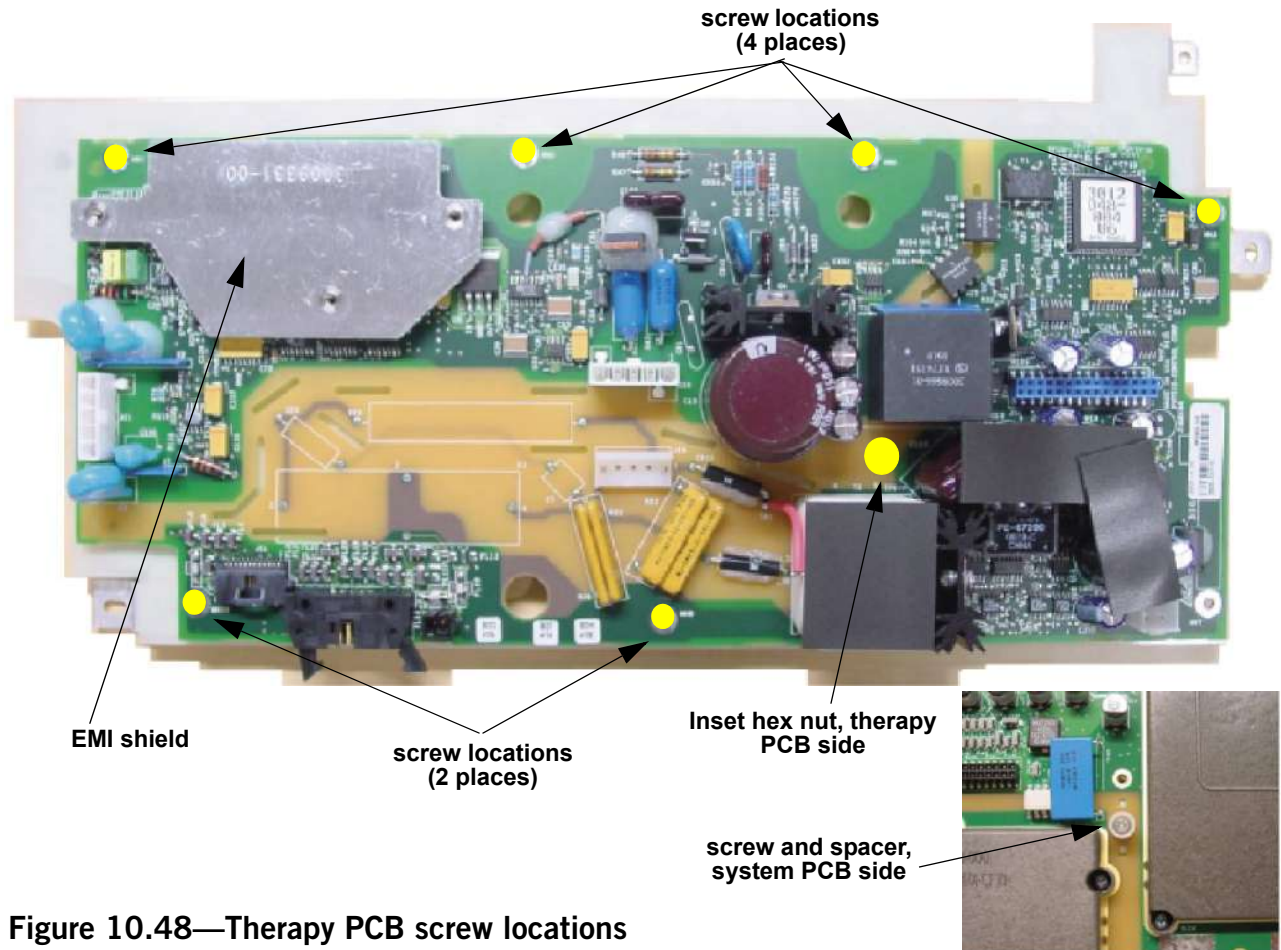

Figure 10.48—Therapy PCB screw locations



◆ To remove the therapy PCB (A04): *(Continued) 9 steps, (Page 3 of 3)*

6. Gently lift the therapy PCB up and away from the system PCB. The two PCBs are linked by the 30-pin header, which is a direct-connection contact assembly.
7. Remove the 30-pin header assembly from the therapy board (3009878-002).
8. Remove the three retaining screws (202253-761) from the EMI shield (3009331-00) on the therapy board. Discard the screws.
9. Remove the EMI shield.

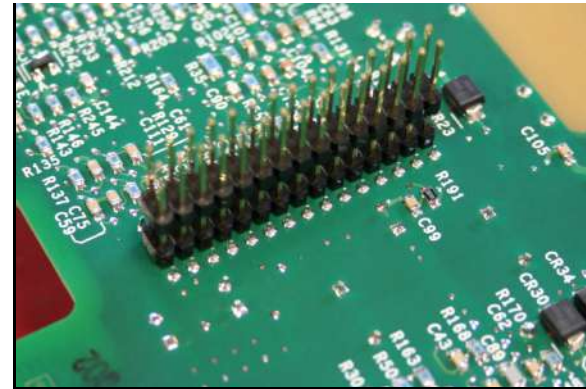
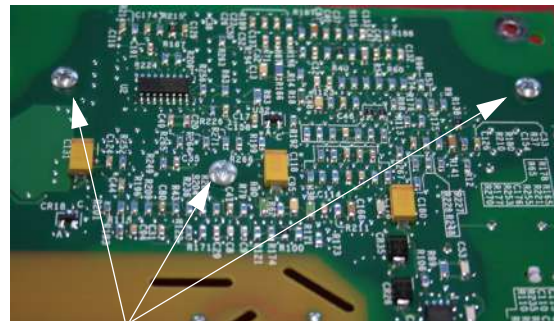

Figure 10.49—30-pin header (therapy PCB side)



screws  
(3 places)

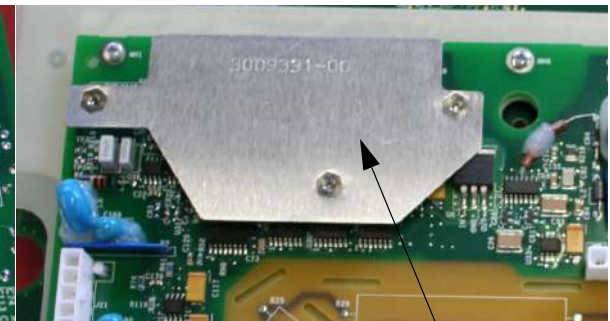

Figure 10.49—Therapy EMI shield and screw locations

EMI shield

### Replacing the Therapy PCB (A04)

◆ To replace the therapy PCB (A04): *9 steps, (Page 1 of 3)*

**NOTE:** When replacing the therapy PCB, use the [Therapy PCBA Repair Kit \(MIN 3305431-008\)](#) (p. 619).

1. Place the EMI shield ([3009331-00](#)) on the therapy PCB and insert using three new screws ([202253-761](#)); torque to 6.8 in-lb.
2. Place system PCB facedown on the work surface with the system/therapy mounting bracket installed.
3. Verify that the 30 pin header has no bent pins, and insert the 30 pin header (W03) ([3009878-002](#)) into the J50 circuit side of the therapy PCB.
4. Place the spacer ([3011630-00](#)) into hole in system/therapy mounting bracket with small end of spacer facing up.

◆ To replace the therapy PCB (A04): *(Continued) 9 steps, (Page 2 of 3)*

5. Align the therapy PCB with the system PCB. Insert the 30 pin header into J5 of system PCB and align with screw holes in mounting bracket. Ensure that the spacer is protruding from hole in therapy PCB.
6. Attach therapy PCB with six new screws ([202253-761](#)); torque to 6.8 in-lb.
7. Insert the new mounting screw ([202253-550](#)) and spacer ([3011630-00](#)) through the system/therapy assembly and into the insert hex nut ([3011629-00](#)) on the therapy PCB side. Hold nut with 3/8" nutdriver and tighten screw to 6.8 in-lb.

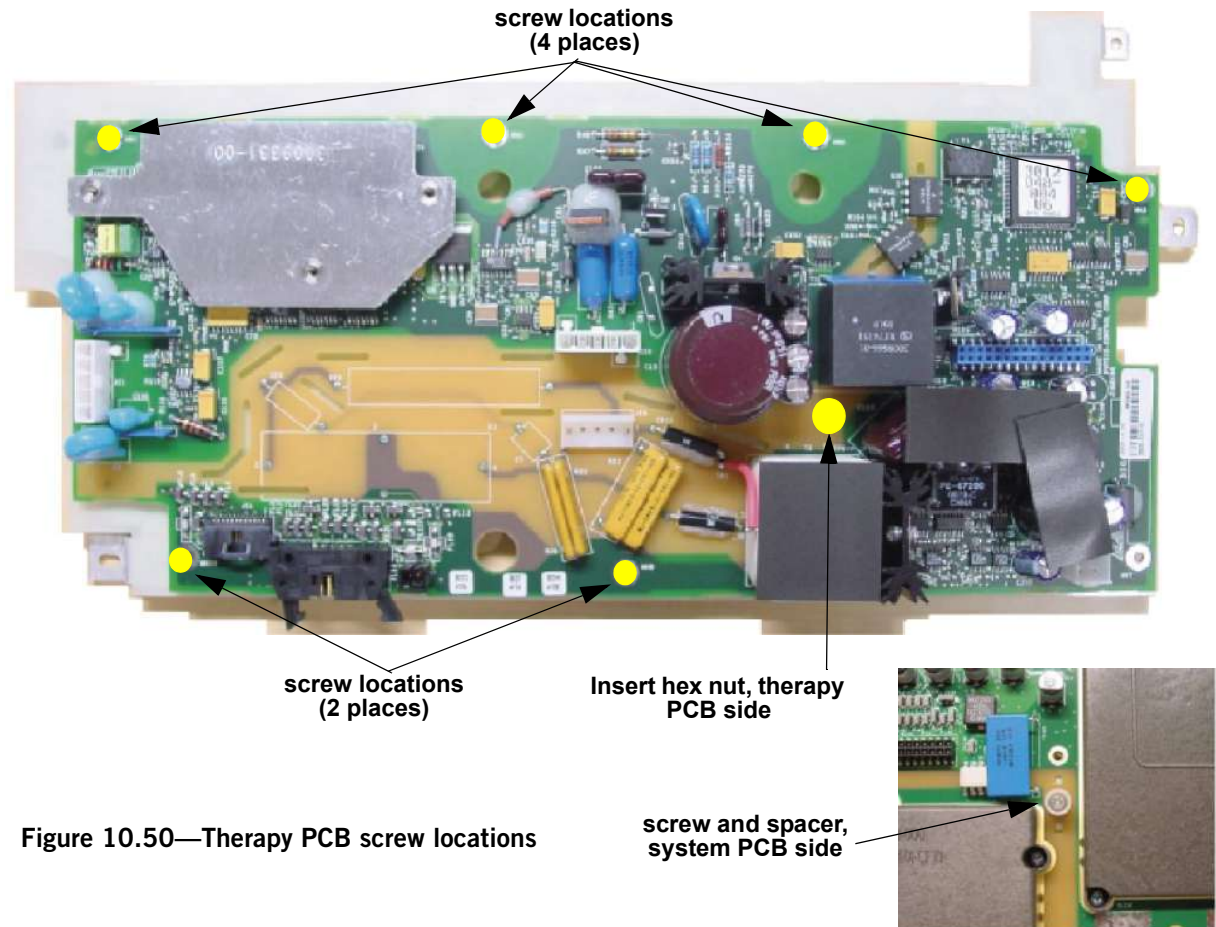

Figure 10.50—Therapy PCB screw locations

- ◆ To replace the therapy PCB (A04): *(Continued) 9 steps, (Page 3 of 3)*
  8. Follow the instructions to install the system/therapy assembly into device as described in [Installing the System \(A01\)/Therapy \(A04\) PCB Assembly \(p. 359\)](#).
  9. After device reassembly, complete the TCP – Defibrillator Calibration procedure (see [TCP – Defibrillator Energy Calibration \(p. 200\)](#)). The defibrillator calibration constants may be invalidated when you replace Therapy PCB.



### Power PCB (A03) Replacement

Power PCB Replacement consists of the following procedures:

- [Removing the Power PCB \(A03\) \(p. 374\)](#)
- [Installing the Power PCB \(A03\) \(p. 377\)](#)

### Removing the Power PCB (A03)

Some parts mentioned in this procedure are optional and may not apply to your device.

◆ To remove the power PCB (A03) from the rear case: *10 steps, (Page 1 of 3)*

1. Disassemble the case as described in [Disassembling the Case \(p. 301\)](#).
2. Remove the system/therapy PCB assembly as described in [System \(A01\)/Therapy \(A04\) PCB Assembly Replacement \(p. 352\)](#).
3. Remove the OEM PCB as described in [Removing the OEM PCB \(A06\) \(p. 382\)](#).
4. For V1 Power PCB (3206749-003): Disconnect the power/contact (W05) at J12, battery pins/power PCB cable (W10) at J11 and J13, and auxiliary power cable (W09) from the power board at J15.
5. For V2 Power PCB (3302519-002): Disconnect the power/contact (W05) at J12, battery pins/power PCB cable (W10) at J11, and auxiliary power cable (W09) at J15-A and J15-B from the Power PCB.

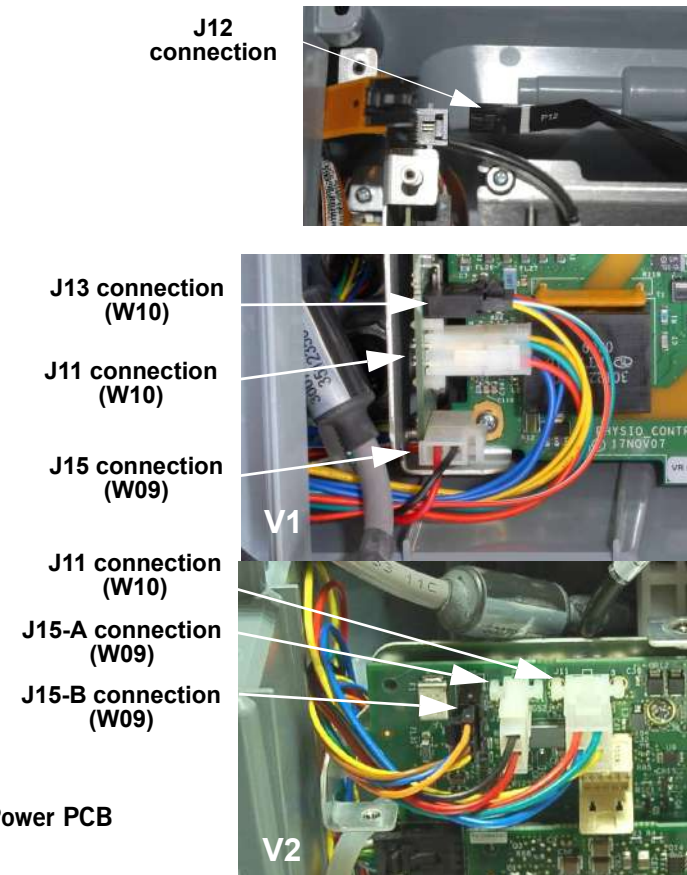

Figure 10.51—Power PCB connections

- ◆ To remove the power PCB (A03) from the rear case: *(Continued) 10 steps, (Page 2 of 3)*
  6. Remove the two screws (202253-761) securing the bracket assembly (3206961-001). Discard the screws.
  7. Lift the power PCB and bracket partially out of the rear case. Use caution not to strain the system connector cable.
  8. Disconnect the two W08 - system cable connectors at J9 and J10 from the power PCB.
  9. If you are replacing the power PCB, remove the six screws (202253-761) securing the PCB to the mounting bracket (3206961-001), and then remove the PCB. Discard the screws.

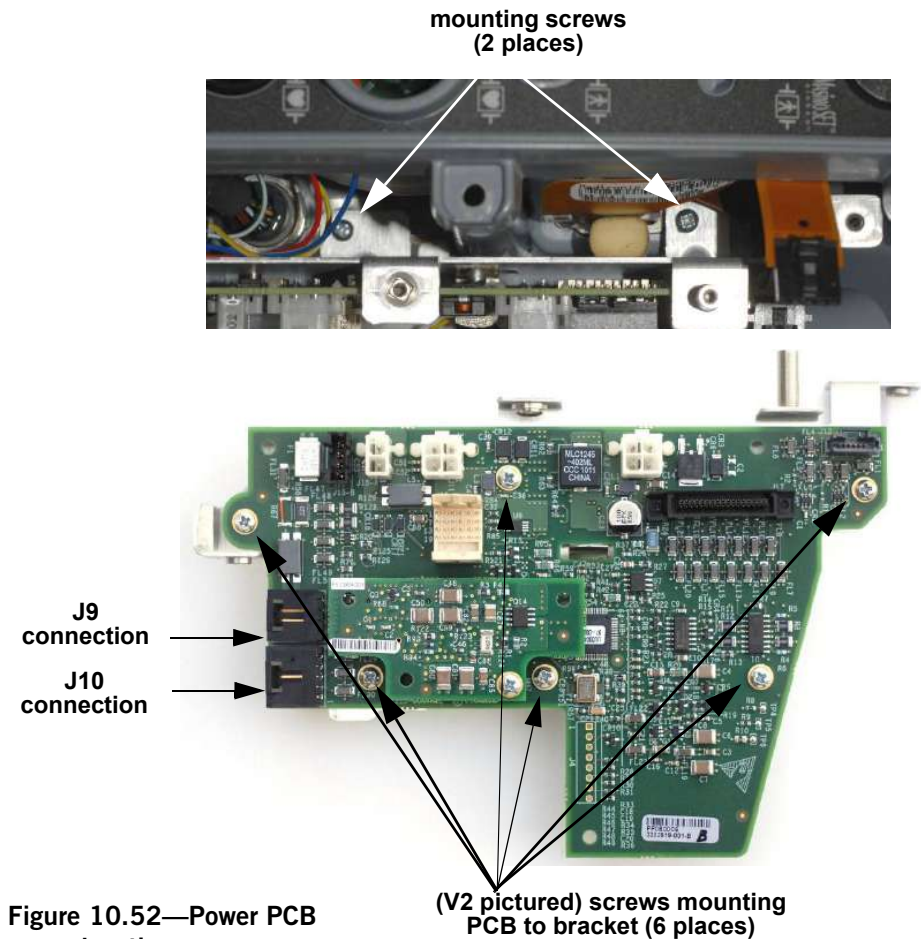

Figure 10.52—Power PCB  
screw locations

- ◆ To remove the power PCB (A03) from the rear case: *(Continued) 10 steps, (Page 3 of 3)*
  10. Remove the W01 power/system PCB cable at J17 for reuse with the new power PCB.

J17  
connection

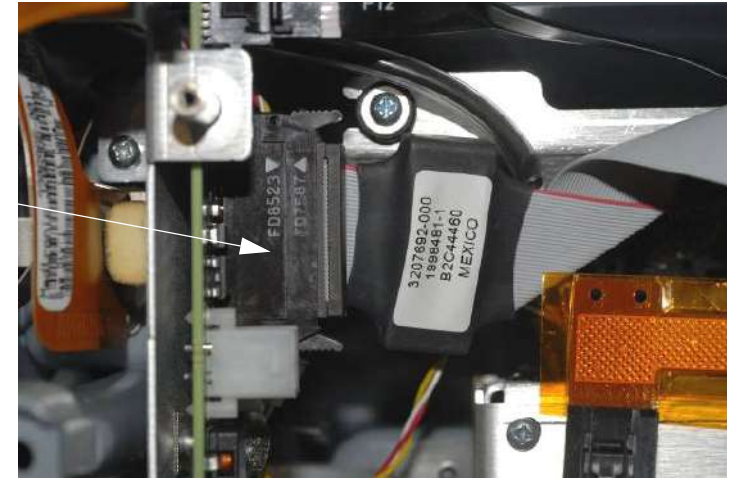

Figure 10.53—Power/system PCB cable

### Installing the Power PCB (A03)

Some parts mentioned in this procedure are optional and may not apply to your device.

- ◆ To install the power PCB (A03) into the rear case: *14 steps, (Page 1 of 4)*

**NOTE:** When installing a new power PCB, use either the [Power PCBA Repair Kit, V1 \(MIN 3305431-006\)](#) (p. 617) or [Power PCBA Repair Kit, V2 \(MIN 3305431-030\)](#) (p. 635).

1. Secure the power PCB to the mounting bracket ([3206961-001](#)) using the six new screws ([202253-761](#)); torque to 6.8 in-lb.
2. Connect the W08 - system connector cables to J09 and J10. If there is an NIBP option, ensure that the NIBP tube is routed above the system connectors.

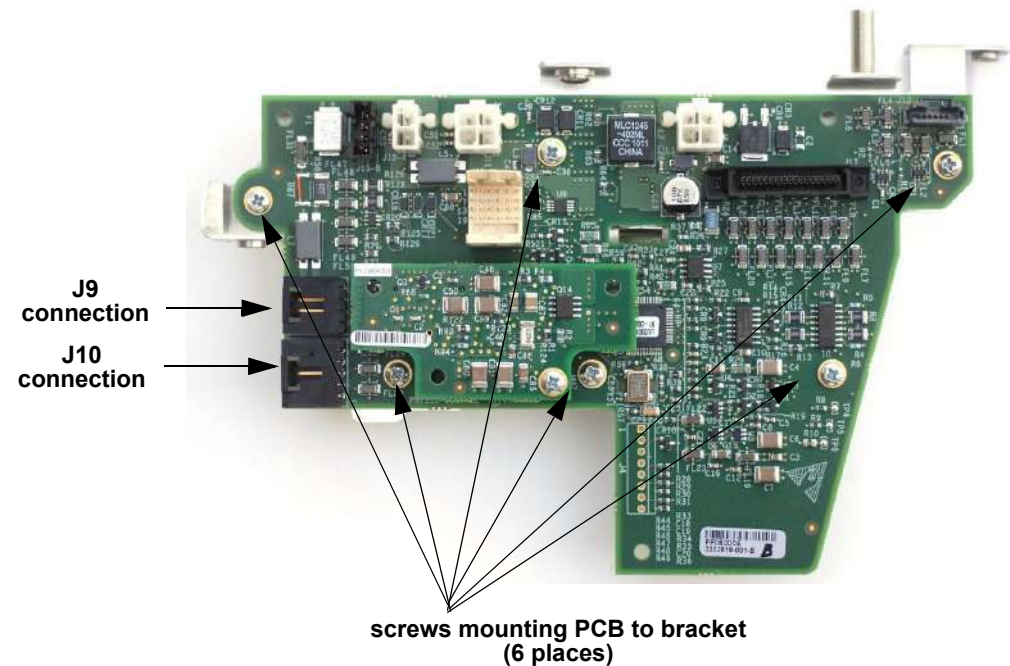

Figure 10.54—Power PCB mounting bracket screw locations

◆ To install the power PCB (A03) into the rear case: *(Continued) 14 steps, (Page 2 of 4)*

3. Mount the power PCB in the case and secure the bracket (3206961-001) to the rear case using two new screws (202253-761); torque to 6.8 in-lb.

**NOTE:** Ensure that the W28 - FRS assembly CO2 tubing/ wiring is above the SpO2 cable and not kinked as it comes through the space provided along right side of the power PCB.

4. Connect power/contact PCB cable (W05) to the power PCB at J12.

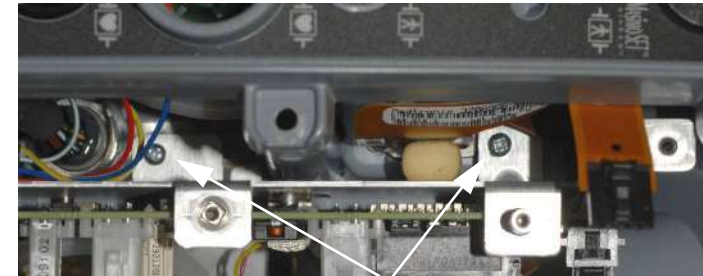

Figure 10.55—Power PCB screw locations

mounting screws  
(2 places)



J12  
connection

Figure 10.56—Power PCB J12 connection



- ◆ To install the power PCB (A03) into the rear case: *(Continued) 14 steps, (Page 3 of 4)*
- 5. For V1 Power PCB (3206749-003): Connect battery pins/power PCB cable (W10) to the power PCB at J11 and J13.
- 6. For V1 Power PCB (3206749-003): Route the auxiliary power cable (W09) over the top of battery pins/power PCB cable (W10). Connect auxiliary power cable to the power PCB at J15.
- 7. For V2 Power PCB (3302519-002): Connect battery pins/power PCB cable (W10) to the power board at J11.
- 8. For V2 Power PCB (3302519-002): Connect the auxiliary cable (W09) 2-pin cable to the power PCB at J15-A. Route the auxiliary power (W09) 4-pin cable over the top of battery pins/power PCB cable (W10) and connect to the power PCB at J15-B.
- 9. Route system connector wires so that they have clearance behind the power PCB.

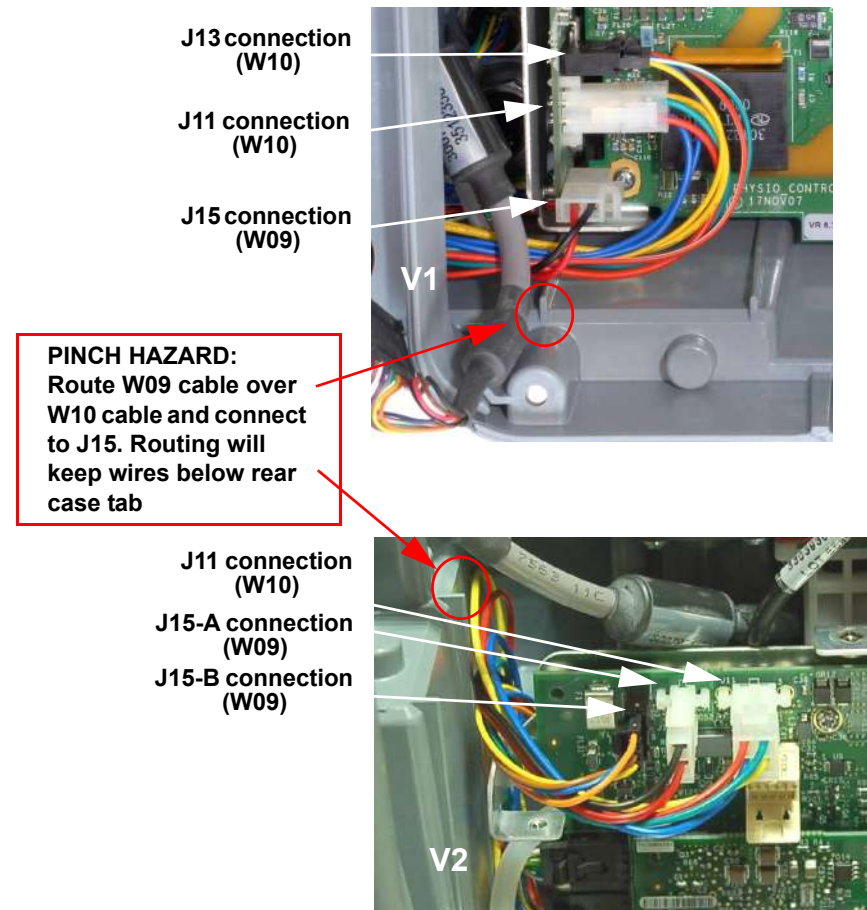

Figure 10.57—Power PCB connections

- ◆ To install the power PCB (A03) into the rear case: *(Continued) 14 steps, (Page 4 of 4)*
  10. Route CO2 adapter cable (W30) above the power/system cable as shown.
  11. Connect the power/system cable (W01) at J17.
  12. Install the OEM PCB as described in [Installing the OEM PCB \(A06\) \(p. 385\)](#).
  13. Install the system/therapy PCB assembly as described in [System \(A01\)/Therapy \(A04\) PCB Assembly Replacement \(p. 352\)](#).
  14. Reassemble the case as described in [Reassembling the Case \(p. 304\)](#).

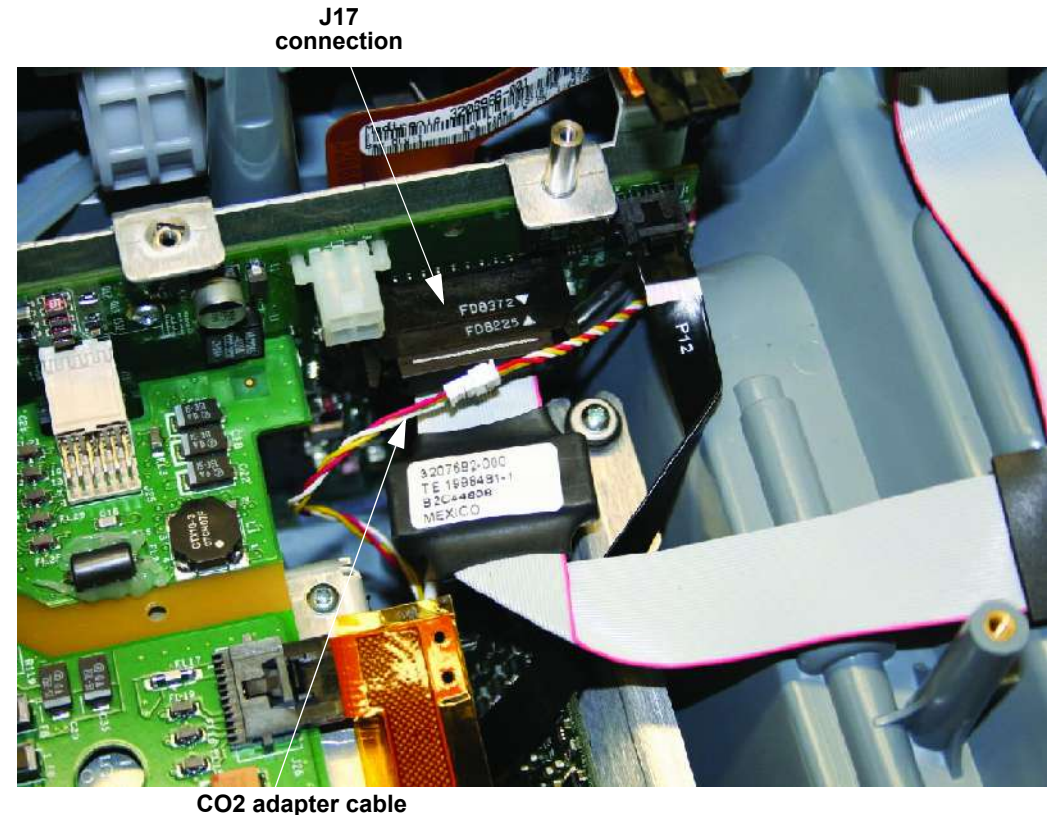

Figure 10.58—Power/system PCB cable (W01)



### OEM PCB (A06) Replacement

OEM PCB Replacement consists of the following procedures:

- [Removing the OEM PCB \(A06\) \(p. 382\)](#)
- [Installing the OEM PCB \(A06\) \(p. 385\)](#)

### Removing the OEM PCB (A06)

Refer to [Inside Rear Case Diagrams \(p. 348\)](#).

- ◆ To remove the OEM PCB (A06) from the rear case: *11 steps, (Page 1 of 3)*
  1. Disassemble the case as described in [Disassembling the Case \(p. 301\)](#).
  2. Remove the system/therapy PCB assembly as described in [System \(A01\)/Therapy \(A04\) PCB Assembly Replacement \(p. 352\)](#).
  3. Disconnect Power/Therapy Cable (W02) ([3009726-05](#)) from J8 on the power PCB.
  4. Remove the OEM shield ([3208298-000](#)).

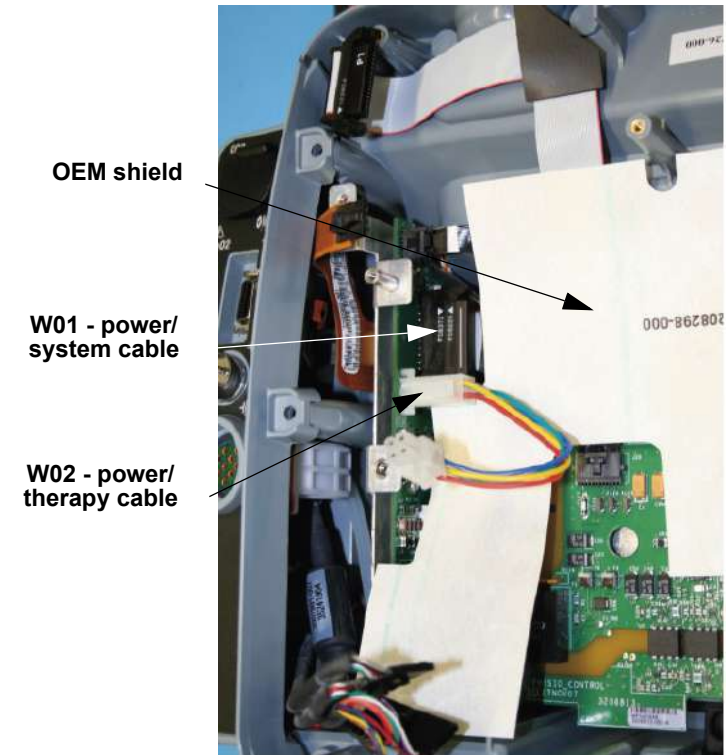

Figure 10.59—OEM PCB shield

- ◆ To remove the OEM PCB (A06) from the rear case: *(Continued) 11 steps, (Page 2 of 3)*
  5. Remove the nylon standoff (3010569-02) from the OEM PCB.
  6. Disconnect the SpO2/OEM cable (W21) (3207000-004) (if present).
  7. Disconnect the CO2/OEM cable (W26) (3206998-002) (if present).
  8. Remove the NIBP connector retainer clip (3010805-000) and disconnect the NIBP/OEM cable (W27) (3012181-02) (if present).

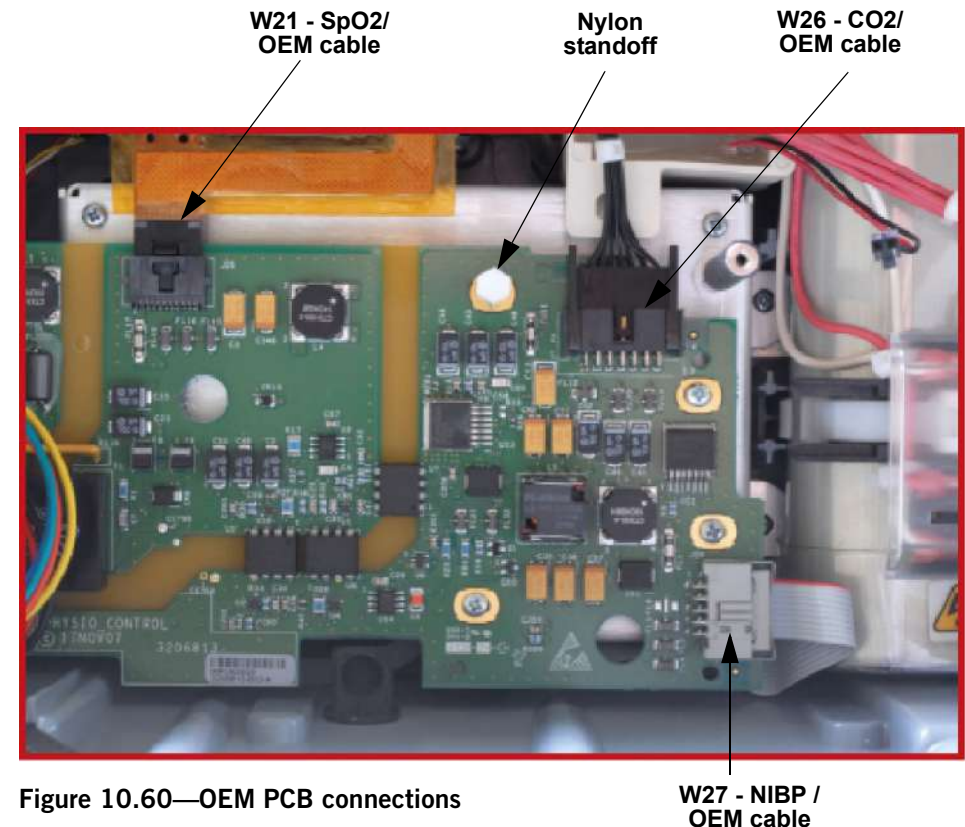
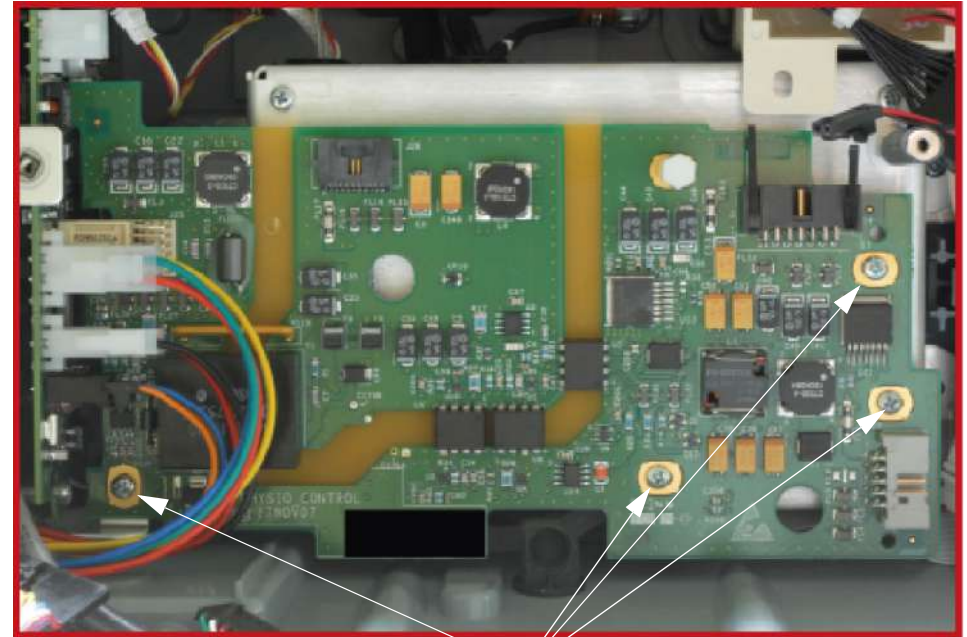

Figure 10.60—OEM PCB connections

- ◆ To remove the OEM PCB (A06) from the rear case: *(Continued) 11 steps, (Page 3 of 3)*
  9. Remove the four mounting screws (202253-761). Discard the screws.
  10. Lift the right edge of the OEM PCB upward slightly, and then slide the PCB to the right (toward the capacitor) to disengage the direct connection between the OEM PCB at J25 and the power PCB at J16.
  11. Lift the OEM board from the rear case.



mounting screws  
(4 places)

Figure 10.61—OEM PCB screw locations

### Installing the OEM PCB (A06)

Refer to [Inside Rear Case Diagrams](#) (p. 348).

- ◆ To install the OEM PCB (A06) into the rear case: *12 steps, (Page 1 of 3)*

**NOTE:** When installing a new OEM PCB, use either the [OEM PCBA Repair Kit, V1 \(MIN 3305431-004\)](#) (p. 615) or [OEM PCBA Repair Kit, V2 \(MIN 3305431-028\)](#) (p. 633).

1. Lift the tab at the upper left corner of the OEM PCB over the ground clip on the power bracket, and then press down on the tab while sliding the OEM PCB to the left to engage the direct connection (J25) to the A03 power PCB at J16.
2. Ensure that the ground tab of the OEM PCB is above the power PCB bracket. Ensure the OEM PCB sits flat on the OEM bracket and presses straight into the power PCB.
3. Install four new screws ([202253-761](#)); torque to 6.8 in-lb.

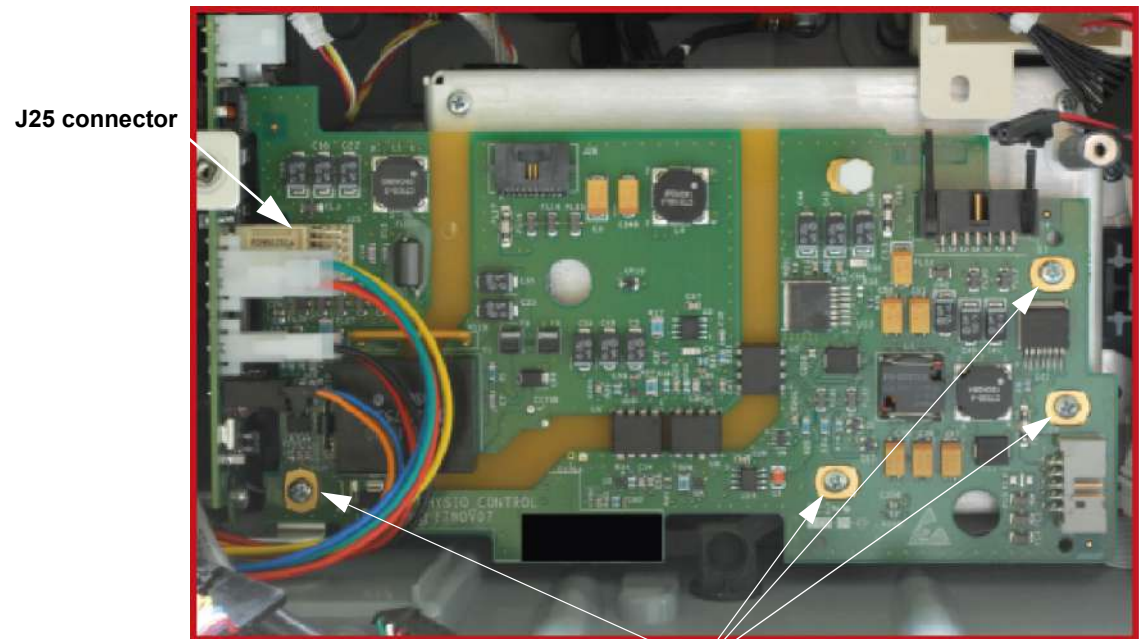

Figure 10.62—OEM PCB screw locations

mounting screws  
(4 places)



- ◆ To install the OEM PCB (A06) into the rear case: *(Continued) 12 steps, (Page 2 of 3)*
  4. Install the nylon standoff (3010569-02) in the OEM hole (torque to 4.0 in-lb using a 1/4" socket).
  5. If present, connect the SpO2/OEM cable (W21) (3207000-004) and ensure locking feature is engaged.
  6. If present, connect the CO2/OEM cable (W26) (3206998-002) and ensure locking feature is engaged.
  7. If present, connect the NIBP/OEM cable (W27) (3012181-02) and lock into place with the retainer clip (3010805-000).

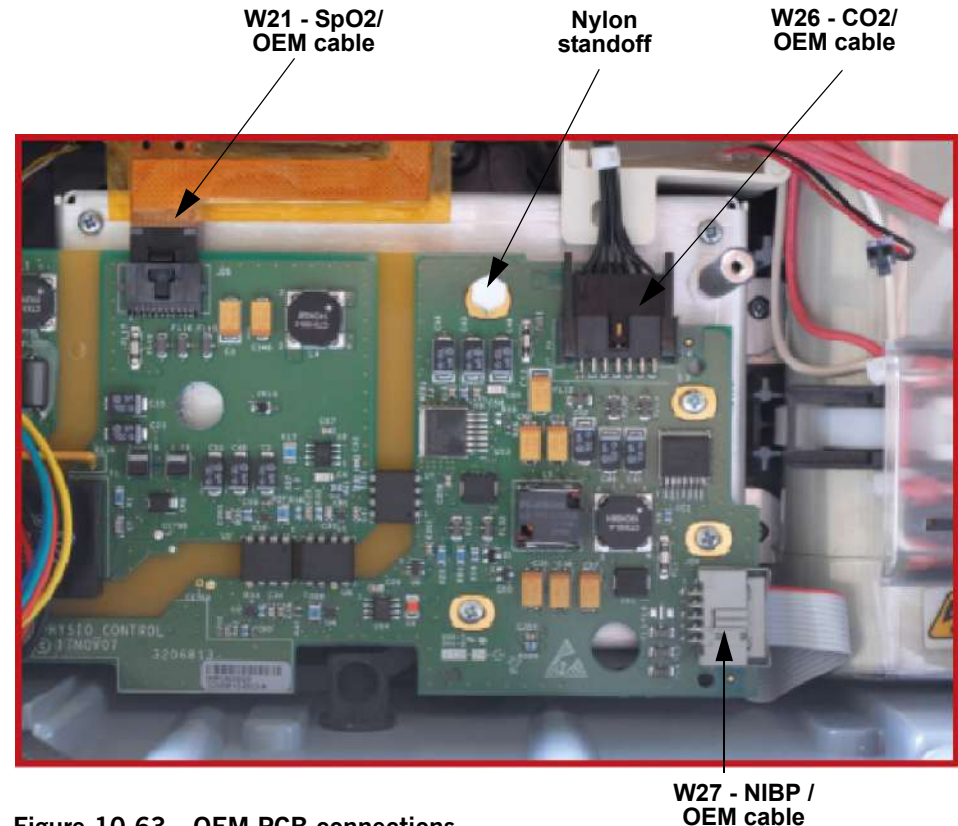

Figure 10.63—OEM PCB connections

- ◆ To install the OEM PCB (A06) into the rear case: *(Continued) 12 steps, (Page 3 of 3)*

**NOTE:** The W01 - power/system PCB cable is under the OEM shield.

8. Install the OEM shield ([3208298-000](#)).
9. Connect the W02 - power/therapy PCB cable ([3010569-02](#)) to J8 on the power PCB.
10. Route the left side of the OEM shield under the power/therapy cable J8 connector and over the top of J11, J13 and J15 connectors on power PCB.
11. Install the system/therapy PCB assembly as described in [System \(A01\)/Therapy \(A04\) PCB Assembly Replacement \(p. 352\)](#).
12. Reassemble the case as described in [Reassembling the Case \(p. 304\)](#).

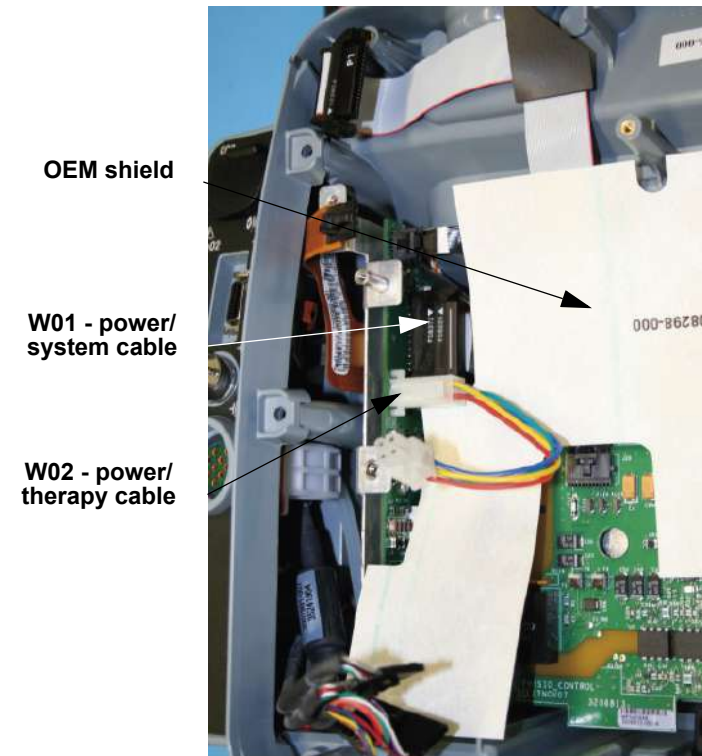

Figure 10.64—OEM PCB shield

### Transfer Relay Assembly (A13) Replacement

Transfer relay assembly replacement consists of the following procedures:

- [Removing the Transfer Relay Assembly \(A13\) \(p. 389\)](#)
- [Installing the Transfer Relay Assembly \(A13\) \(p. 390\)](#)



### Removing the Transfer Relay Assembly (A13)

- ◆ To remove the Transfer Relay Assembly from the rear case:
  1. Disassemble the case as described in [Disassembling the Case \(p. 301\)](#).
  2. Remove the system/therapy PCB assembly as described in [System \(A01\)/Therapy \(A04\) PCB Assembly Replacement \(p. 352\)](#).

#### DANGER

**SHOCK HAZARD** Lethal voltages may be present even without operator action. Always discharge the energy storage capacitor prior to servicing. See the service manual "[Capacitor Discharging Procedure \(p. 298\)](#)" for detailed instructions.

3. Remove the screw ([202253-761](#)) securing the clear, plastic, high-voltage shield ([3010593-00](#)) from the interconnect bracket (A17). Discard the screw.
4. Remove the two mounting screws ([202253-761](#)) from the capacitor bracket and remove the bracket ([3207031-001](#)). Discard the screws.
5. Carefully cut six small cable ties to free the high voltage relay wires from the rear case.
6. Disconnect the white transfer relay lead from the interconnect bracket at pin 7. Needle nose pliers may be used to assist in disconnection.
7. Remove the two biphasic module mounting screws ([3207337-312](#)). Discard the screws.
8. Lift the biphasic bracket up slightly to gain access to connector. Disconnect the red transfer relay lead spade connector from the biphasic modular assembly at J104. Needle nose pliers may be used to assist in disconnection.
9. Lift the high voltage relay out of the rear case.

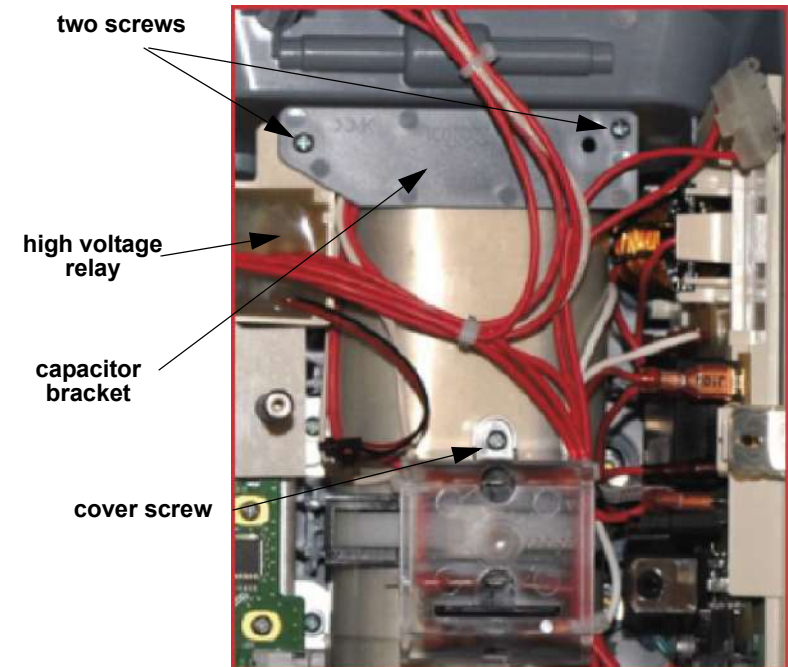

Figure 10.65—Transfer relay parts and screw locations

### Installing the Transfer Relay Assembly (A13)

Refer to [Figure 10.65 on p. 389](#).

◆ To install the Transfer Relay Assembly into the rear case:

**NOTE:** When installing a new transfer relay assembly ([3008897-002](#)) use the [Internal Hardware Repair Kit \(MIN 3305431-015\) \(p. 624\)](#) and [External Hardware Repair Kit \(MIN 3305431-016\) \(p. 624\)](#).

**NOTE:** The coil end of the Transfer Relay Assembly fits into a recess in the case. No screw is installed in the lower mounting hole of the transfer relay.

1. With biphasic bracket up slightly for access to J104 connector, connect the red transfer relay lead spade connector to the biphasic modular assembly at J104.
2. Install the biphasic PCB/bracket assembly into the rear case with two new screws ([3207337-312](#)); torque to 6.8 in-lb.
3. Connect the white transfer relay lead to the interconnect bracket at pin 7 (see [Figure 10.65 on p. 389](#)). Needle nose pliers may be used to assist in the connection.
4. Place the transfer relay assembly into the rear case.
5. Install the capacitor bracket ([3207031-001](#)) using two new screws ([202253-761](#)); torque to 6.8 in-lb (see [Figure 10.65 on p. 389](#)).
6. See the [Energy Transfer Detail Diagram](#) for terminal connections and install the six cable ties ([200536-001](#)) at locations shown.
7. Install the clear, plastic, high-voltage shield ([3010593-00](#)) to the interconnect bracket (A17) using new screw ([202253-761](#)); torque to 6.8 in-lb.
8. Install the system/therapy PCB assembly as described in [System \(A01\)/Therapy \(A04\) PCB Assembly Replacement \(p. 352\)](#).
9. Reassemble the case as described in [Reassembling the Case \(p. 304\)](#).
10. After device reassembly, complete the TCP – Defibrillator Calibration procedure (see [TCP – Defibrillator Energy Calibration \(p. 200\)](#)). The defibrillator calibration constants may be invalidated when you replace Defibrillator Energy delivery components.

### Energy Storage Capacitor (A15) Replacement

Energy storage capacitor replacement consists of the following procedures:

- [Removing the Energy Storage Capacitor \(A15\) \(p. 392\)](#)
- [Installing the Energy Storage Capacitor \(A15\) \(p. 393\)](#)

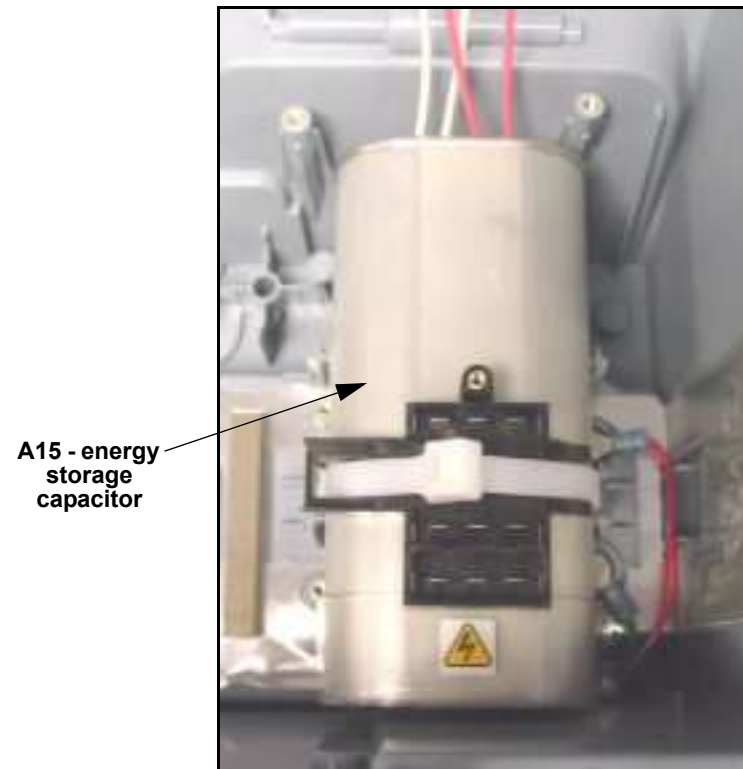
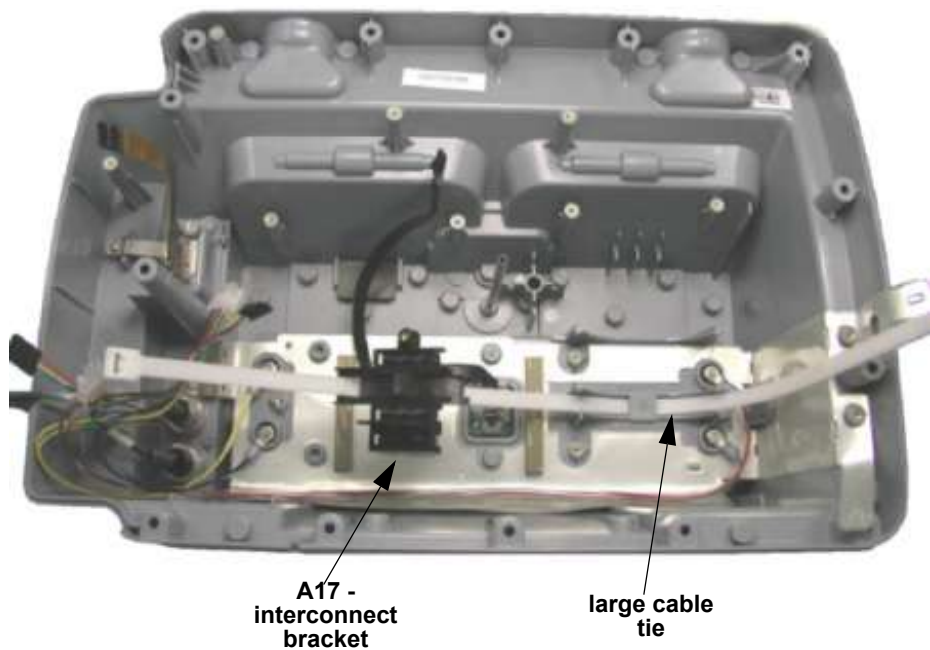

Figure 10.66—Capacitor and cable tie locations

### Removing the Energy Storage Capacitor (A15)

◆ To remove the Energy Storage Capacitor from the rear case:

1. Disassemble the case as described in [Disassembling the Case \(p. 301\)](#).
2. Remove the system/therapy PCB assembly as described in [System \(A01\)/Therapy \(A04\) PCB Assembly Replacement \(p. 352\)](#).
3. Remove the transfer relay as described in [Removing the Transfer Relay Assembly \(A13\) \(p. 389\)](#).  
**NOTE:** It is not necessary to remove the spade terminals as described in the procedure.
4. Disconnect the energy storage capacitor (3008164-002) white lead from the interconnect bracket at pin 1. Needle nose pliers may be used to assist in disconnection.
5. Disconnect the energy storage capacitor red lead from the interconnect bracket at pin 4. Needle nose pliers may be used to assist in disconnection.
6. Cut the restraining large cable tie (200536-011) from the interconnect bracket.
7. Lift out the interconnect bracket and storage capacitor from the case.

### Installing the Energy Storage Capacitor (A15)

◆ To install the Energy Storage Capacitor into the rear case:

**NOTE:** When installing a new energy storage capacitor (3008164-002) use the [Internal Hardware Repair Kit \(MIN 3305431-015\)](#) (p. 624) and [External Hardware Repair Kit \(MIN 3305431-016\)](#) (p. 624).

1. Secure the energy storage capacitor and interconnect bracket to the rear case with the large cable tie ([200536-011](#)). Place the bottom of energy storage capacitor flush to the rear case.
2. Route the energy storage capacitor wires along left side of capacitor body.
3. Install the transfer relay assembly as described in [Installing the Transfer Relay Assembly \(A13\)](#).
4. Connect the energy capacitor white lead to the interconnect bracket at pin 1.
5. Connect the energy capacitor red lead to the interconnect bracket at pin 4.
6. Install the interconnect bracket as described in [Installing the Interconnect Bracket \(A17\)](#).
7. Install the system/therapy PCB assembly as described in [System \(A01\)/Therapy \(A04\) PCB Assembly Replacement](#) (p. 352).
8. Reassemble the case as described in [Reassembling the Case](#) (p. 304).
9. After device reassembly, complete the TCP – Defibrillator Calibration procedure (see [TCP – Defibrillator Energy Calibration](#) (p. 200)). The defibrillator calibration constants may be invalidated when you replace Defibrillator Energy delivery components.

### SpO2 PCB (A16) Replacement

SpO2 PCB Replacement consists of the following procedures:

- [Removing the SpO2 PCB \(A16\) \(p. 395\)](#)
- [Installing the SpO2 PCB \(A16\) \(p. 400\)](#)

### Removing the SpO2 PCB (A16)

- ◆ To remove the SpO2 PCB from the rear case (see [Figure 11.21 on p. 533](#)): *13 steps, (Page 1 of 5)*
  1. Disassemble the case as described in [Disassembling the Case \(p. 301\)](#).
  2. Remove the system/therapy PCB assembly as described in [System \(A01\)/Therapy \(A04\) PCB Assembly Replacement \(p. 352\)](#).
  3. Remove the OEM shield ([3208298-000](#)).
  4. Disconnect the power/contact PCB cable (W05) from the power board J12.
  5. Remove power/system cable (W01) from the power board J17.
  6. Remove the power/therapy cable (W02) ([3009726-05](#)) from J8 on the power PCB.

J12  
connection

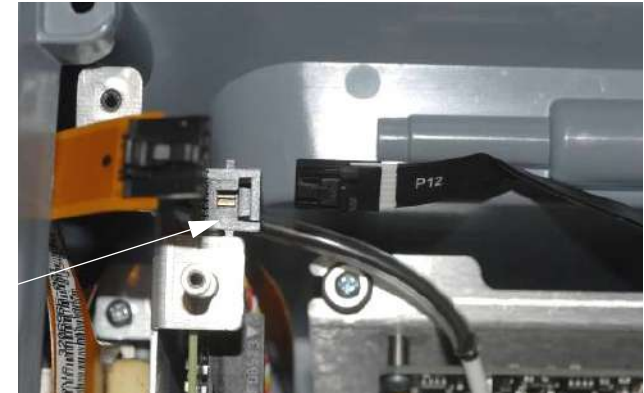

J17  
connection

J8  
connection

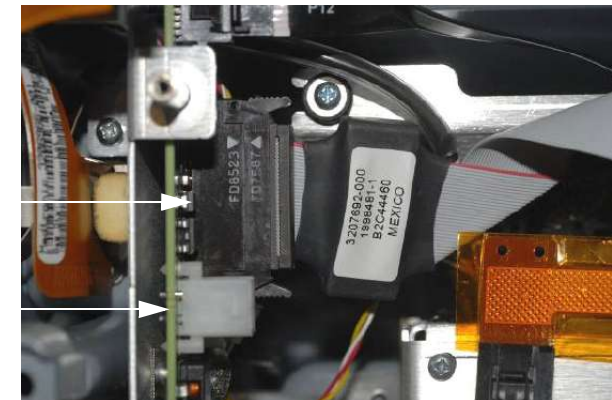
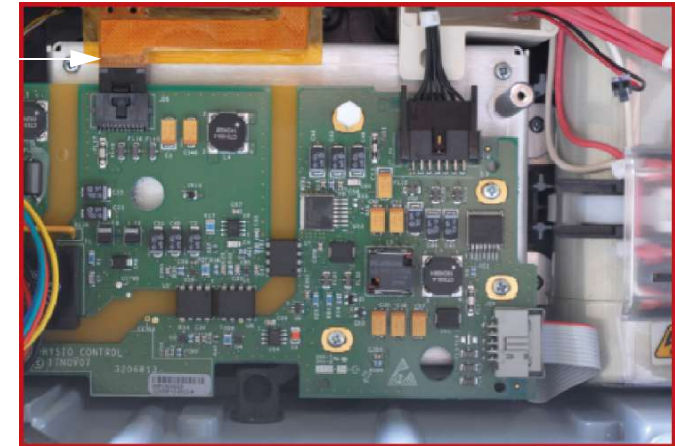

Figure 10.67—Power/system PCB connections



- ◆ To remove the SpO2 PCB from the rear case (see [Figure 11.21 on p. 533](#)): *(Continued) 13 steps, (Page 2 of 5)*
  7. Disconnect the SpO2/OEM cable (W21) ([3207000-004](#)) from OEM PCB J26.
  8. Carefully disconnect the SpO2 connector flex cable (W22) ([3206995-004](#)) from J1 of SpO2 PCB.

W21 - SpO2/  
OEM cable



### CAUTION

**POSSIBLE COMPONENT DAMAGE** The SpO2 connector flex cable can be damaged during disassembly. If SpO2 connector is damaged, replace the SpO2 flex cable using the [MASIMO SpO2 Panel Mount Cable Repair Kit \(MIN 3305431-026\)](#) (p. 631).

J1  
connection

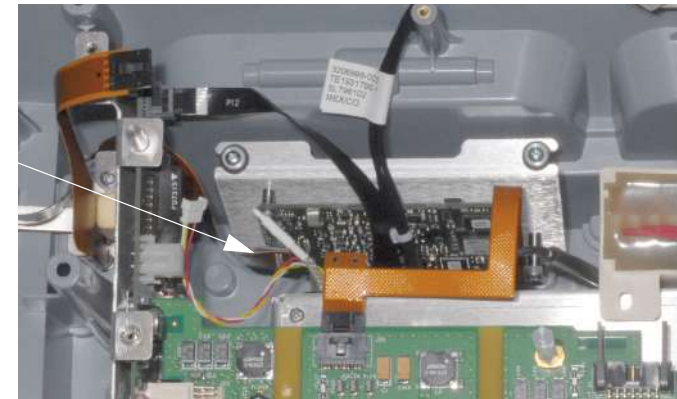

Figure 10.68—SpO2 PCB connections



- ◆ To remove the SpO2 PCB from the rear case (see [Figure 11.21 on p. 533](#)): *(Continued) 13 steps, (Page 3 of 5)*
  9. Remove the two screws ([202253-764](#)) securing the mounting bracket ([3206962-001](#)). Discard the screws.
  10. Lift the SpO2 assembly ([3207034-002](#)) out of the rear case.

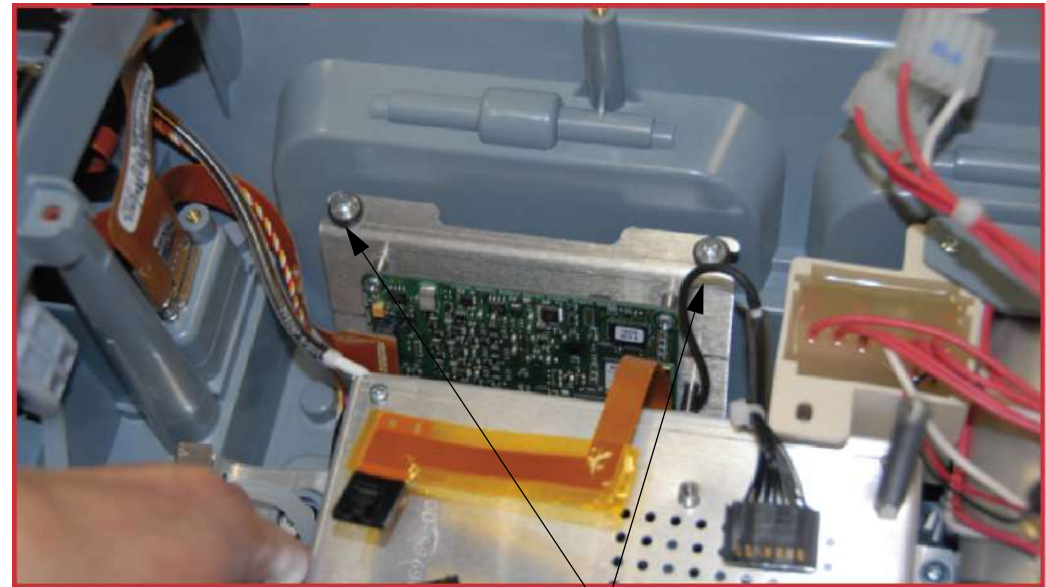

Figure 10.69—SpO2 mounting bracket

screw  
locations

- ◆ To remove the SpO2 PCB from the rear case (see [Figure 11.21 on p. 533](#)): *(Continued) 13 steps, (Page 4 of 5)*
  11. To remove the SpO2 flex cable, remove the one screw (202253-760) attaching the SpO2/OEM flex cable (W21) (3207000-004) from the SpO2 module. Discard the screw.

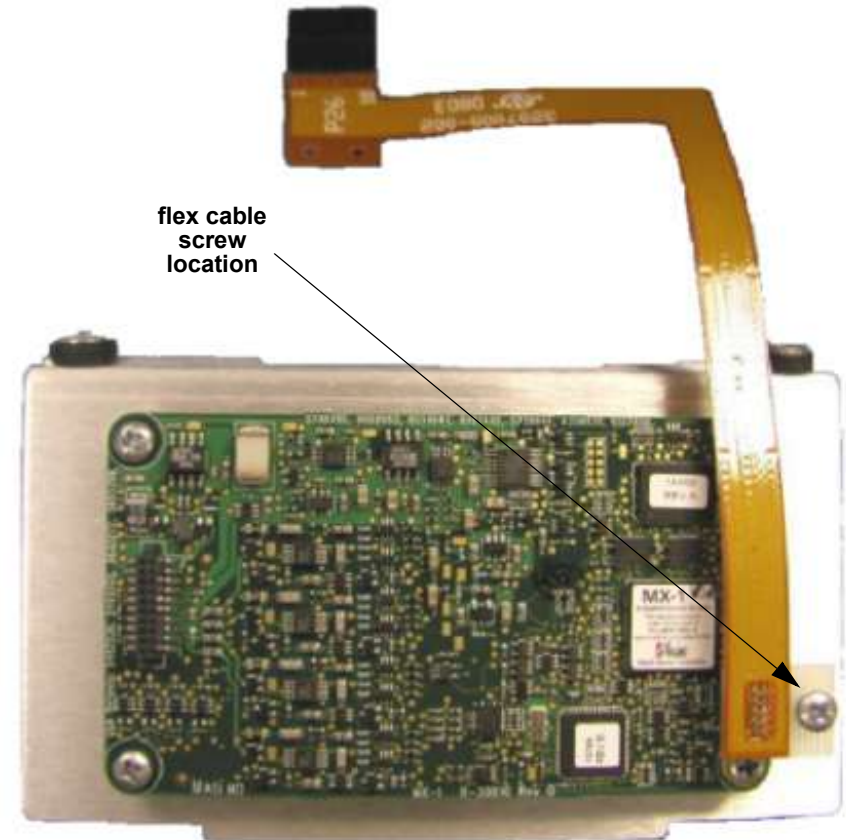

Figure 10.70—SpO2 flex cable screw

- ◆ To remove the SpO2 PCB from the rear case (see [Figure 11.21 on p. 533](#)): *(Continued) 13 steps, (Page 5 of 5)*
  12. To remove the SpO2 module from the bracket, remove the four screws ([202253-760](#)) that attach the SpO2 module to the mounting bracket. Discard the screws.
  13. Lift the SpO2 module off of the mounting bracket.

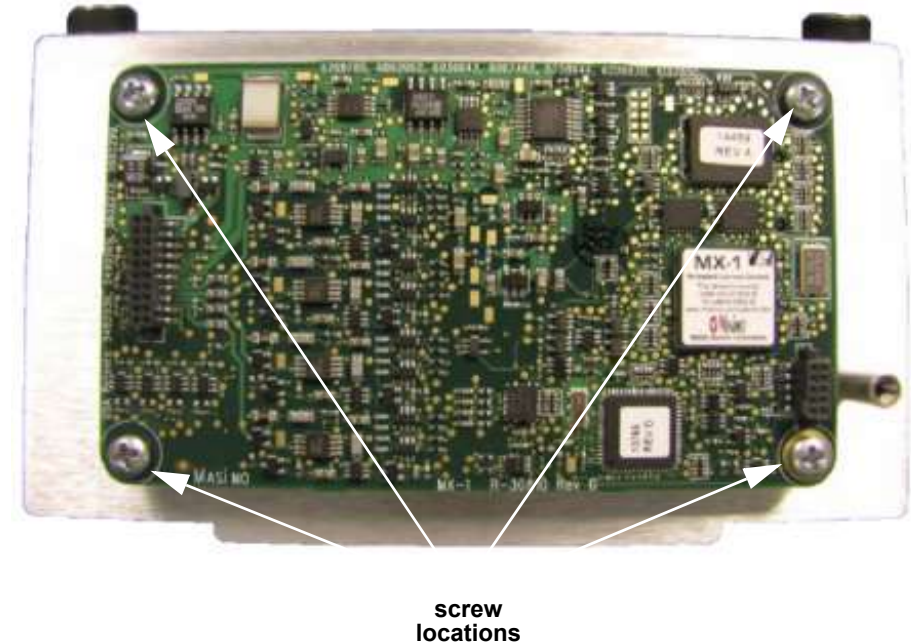

Figure 10.71—SpO2 PCB screw locations

### Installing the SpO2 PCB (A16)

**NOTE:** When installing a new SpO2 PCB, use the [MASIMO SpO2 Module Repair Kit \(MIN 3305431-025\)](#) (p. 630).

- ◆ To install the SpO2 Module in the rear case (see [Figure 11.21](#) on p. 533): *13 steps, (Page 1 of 4)*
  1. Install the SpO2 module ([3207034-002](#)) on the mounting bracket.
  2. Attach the SpO2 module to the bracket using four new screws ([202253-760](#)); torque to 4.0 in-lb (see [Figure 10.71](#) on p. 399).
  3. Attach the SpO2/OEM flex cable (W21) to the SpO2 module using one new screw ([202253-760](#)); torque to 4.0 in-lb.
  4. Connect the SpO2 connector flex cable (W22) ([3206995-004](#)) to J1 of the SpO2 PCB.

**NOTE:** If installing the SpO2 connector flex cable (W22), refer to [SpO2 Connector Cable \(W22\) Replacement](#) (p. 464).

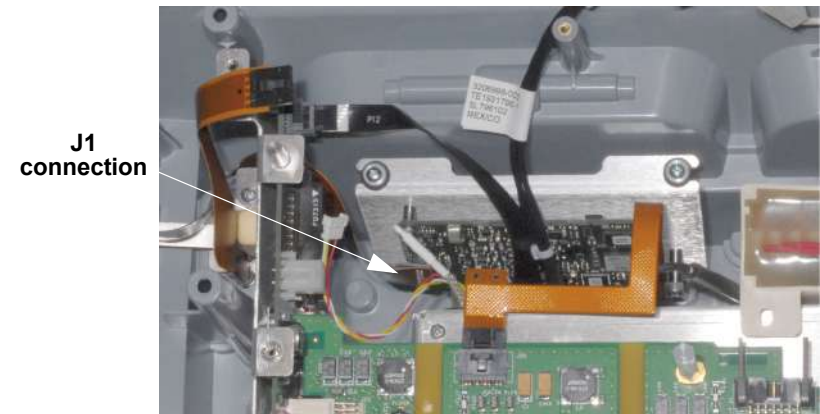
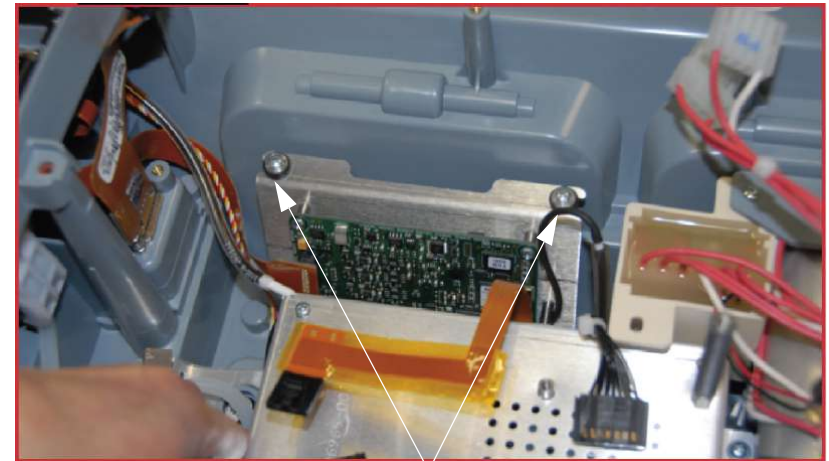

Figure 10.72—SpO2 PCB connection

- ◆ To install the SpO2 Module in the rear case (see [Figure 11.21 on p. 533](#)): *(Continued) 13 steps, (Page 2 of 4)*
  5. Install the mounting bracket ([3206962-001](#)) using two new screws ([202253-764](#)); torque to 6.8 in-lb.



screw locations

Figure 10.73—SpO2 mounting bracket



- ◆ To install the SpO2 Module in the rear case (see [Figure 11.21 on p. 533](#)): *(Continued) 13 steps, (Page 3 of 4)*
  6. Connect the SpO2/OEM cable (W21) ([3207000-004](#)) to the OEM PCB at J26.
  7. Connect the power/contact cable (W05) to the power board at J12.

**J26  
connection**

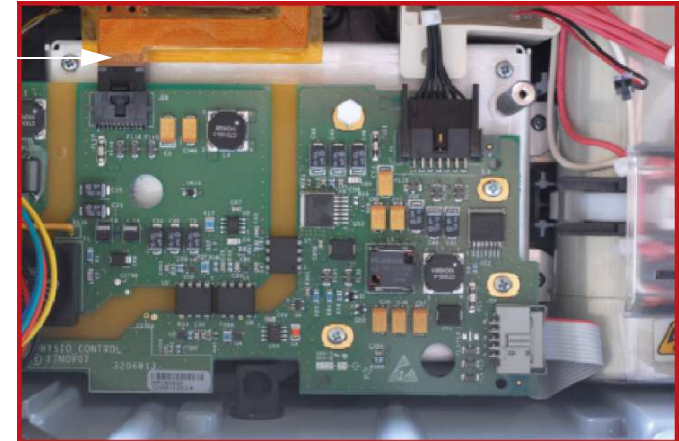

Figure 10.74—SpO2 connection to OEM PCB

**J12  
connection**



Figure 10.75—Power PCB J12 connection

- ◆ To install the SpO2 Module in the rear case (see [Figure 11.21 on p. 533](#)): *(Continued) 13 steps, (Page 4 of 4)*
  8. Route CO2 adapter cable (W30) above the power/system cable as shown.
  9. Install power/system cable (W01) to the power board at J17.
  10. Install the OEM shield ([3208298-000](#)). Route below the J8 connector and the J11 and J15 connectors.
  11. Install the power/therapy cable (W02) ([3009726-05](#)) to J8 on the power PCB.
  12. Install the system/therapy PCB assembly as described in [System \(A01\)/Therapy \(A04\) PCB Assembly Replacement \(p. 352\)](#).
  13. Reassemble the case as described in [Reassembling the Case \(p. 304\)](#).

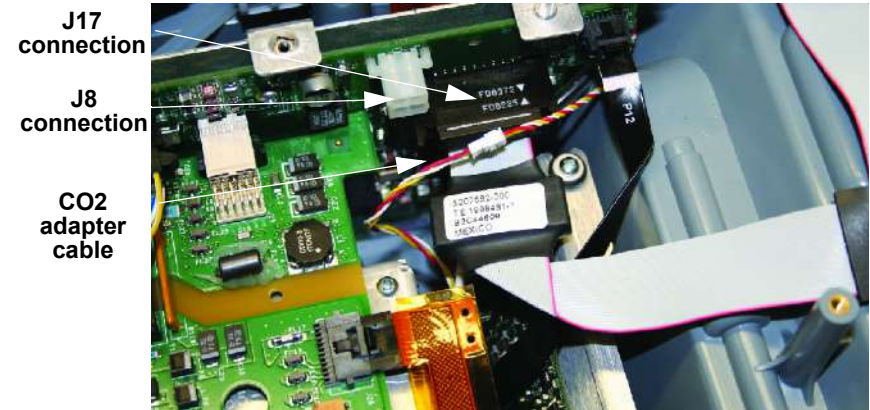

Figure 10.76—Power/system PCB connections

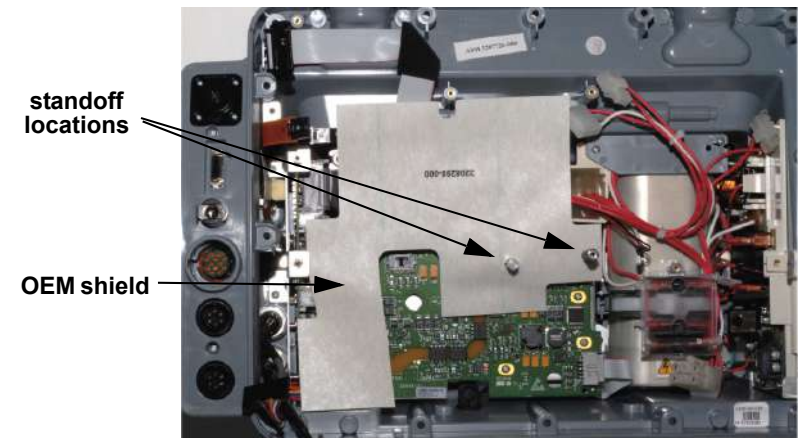

Figure 10.77—OEM shield

### Interconnect Bracket (A17) Replacement

Interconnect bracket replacement consists of the following procedures:

- [Removing the Interconnect Bracket \(A17\) \(p. 405\)](#)
- [Installing the Interconnect Bracket \(A17\) \(p. 406\)](#)



interconnect  
bracket



Figure 10.78—Interconnect bracket location



### Removing the Interconnect Bracket (A17)

Refer to [Figure 10.78](#) on p. 404.

- ◆ To remove the interconnect bracket from the rear case:
  1. Disassemble the case as described in [Disassembling the Case](#) (p. 301).
  2. Remove the system/therapy PCB assembly as described in [System \(A01\)/Therapy \(A04\) PCB Assembly Replacement](#) (p. 352).
  3. Remove the two mounting screws (202253-761) from the capacitor bracket and remove the bracket (3207031-001). Discard the screws.

#### DANGER

**SHOCK HAZARD** Lethal voltages may be present even without operator action. Always discharge the energy storage capacitor prior to servicing. See the service manual "[Capacitor Discharging Procedure](#) (p. 298)" for detailed instructions.

4. Remove the screw (202253-761) securing the clear, plastic, high-voltage shield (3010593-00) from the interconnect bracket. Discard the screw.
5. Cut the cable ties that secure the interconnect bracket wiring.
6. Remove all spade terminals from the interconnect bracket terminals. A gripping tool may be necessary.
7. Cut the large tie wrap securing the interconnect bracket.

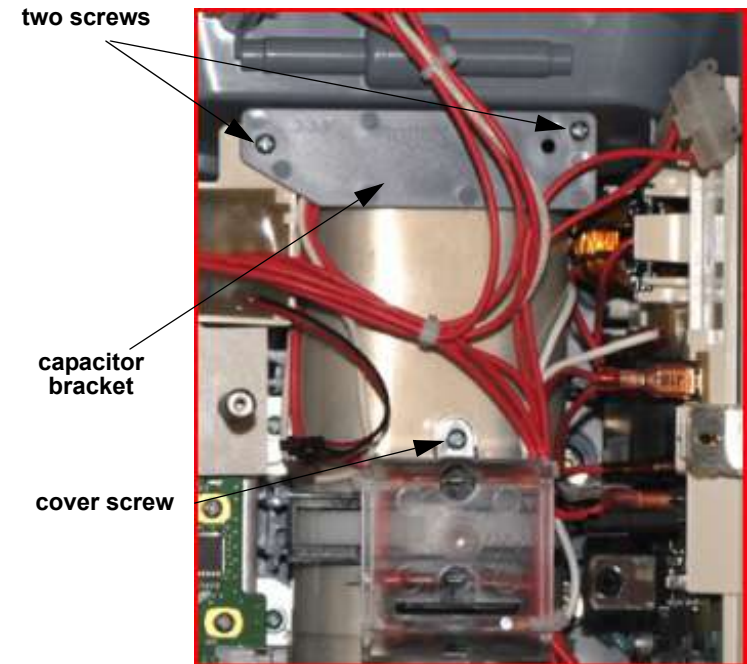

Figure 10.79—Interconnect bracket screw locations

### Installing the Interconnect Bracket (A17)

Refer to [Figure 10.78 on p. 404](#) and [Figure 10.79 on p. 405](#).

- ◆ To install the interconnect bracket into the rear case:

**NOTE:** When installing a new interconnect bracket (3008897-002) use the [Internal Hardware Repair Kit \(MIN 3305431-015\) \(p. 624\)](#) and [External Hardware Repair Kit \(MIN 3305431-016\) \(p. 624\)](#).

1. Secure the interconnect bracket with the large cable tie. To assist in installation of cable tie, add a 30 degree inward bend to the end of the cable tie. Feed the large tie through the left hole of the bracket, then through the rear case, then through the right hole of the bracket. Tighten so that the tie collar fits on the triangular point of the interconnect bracket (see [Figure 10.66 on p. 391](#)). Cut off excess length of the cable tie.

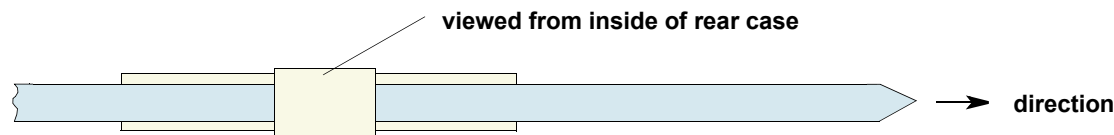

**Figure 10.80— Large cable tie direction**

2. Connect all spade terminals to the interconnect bracket.
3. Install the cable ties that secure the interconnect bracket wiring (see the [Energy Transfer Detail Diagram \(p. 351\)](#) for cable tie locations).
4. Secure the clear plastic high-voltage shield (3010593-00) to the interconnect bracket with one new screw (202253-761); torque to 6.8 in-lb (see [Figure 10.79 on p. 405](#)).
5. Secure the capacitor bracket (3207031-001) with two new screws (202253-761); torque to 6.8 in-lb (see [Figure 10.79 on p. 405](#)).
6. Install the system/therapy PCB assembly as described in [System \(A01\)/Therapy \(A04\) PCB Assembly Replacement \(p. 352\)](#).
7. Reassemble the case as described in [Reassembling the Case \(p. 304\)](#).

### **NIBP (A21)/CO2 (A23) Module Replacement**

NIBP/CO2 module replacement consists of the following procedures:

- [Removing the NIBP \(A21\)/CO2 \(A23\) Modules \(p. 408\)](#)
- [Installing the NIBP \(A21\)/CO2 \(A23\) Modules \(p. 412\)](#)

### Removing the NIBP (A21)/CO2 (A23) Modules

To remove the NIBP and CO2 modules as a unit from the rear case: *17 steps, (Page 1 of 4)*

1. Disassemble the case as described in [Disassembling the Case \(p. 301\)](#).
2. Remove the system/therapy PCB assembly as described in [System \(A01\)/Therapy \(A04\) PCB Assembly Replacement \(p. 352\)](#).
3. Remove the transfer relay assembly as described in [Removing the Transfer Relay Assembly \(A13\) \(p. 389\)](#).

**NOTE:** It is not necessary to remove the spade terminals as described in the procedure.

4. Remove the OEM PCB as described in [Removing the OEM PCB \(A06\) \(p. 382\)](#).
5. Remove the three mounting bracket screws ([3207337-312](#)). Discard the screws.
6. If present, disconnect the CO2 exhaust tube. Lift the assembly as needed.

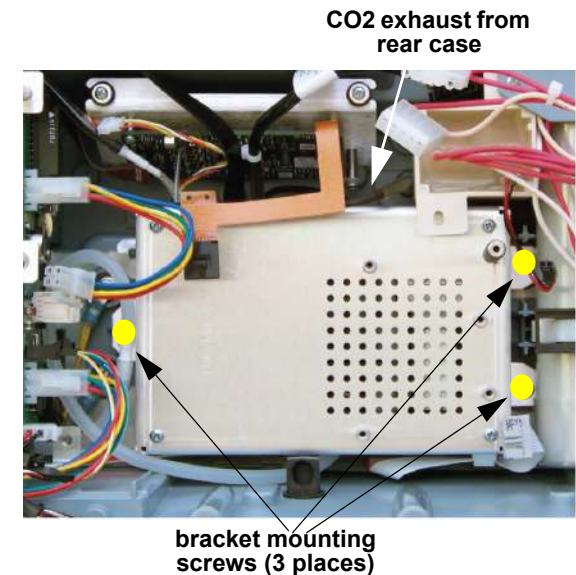

Figure 10.81—CO2/NIBP mounting bracket

To remove the NIBP and CO2 modules as a unit from the rear case: *(Continued) 17 steps, (Page 2 of 4)*

7. If present, disconnect the CO2 inlet tube. Lift the assembly as needed.
8. If present, disconnect the CO2 cable connector inlet cable connector (W28) from CO2 adapter cable (W30).
9. If present, disconnect the NIBP inlet tube. Lift the assembly as needed.
10. Lift the mounting bracket and cover from the rear case.

**W28-W30  
CO2 inlet cable  
connector**

**CO2 inlet tube**

**CO2 hose from  
module**

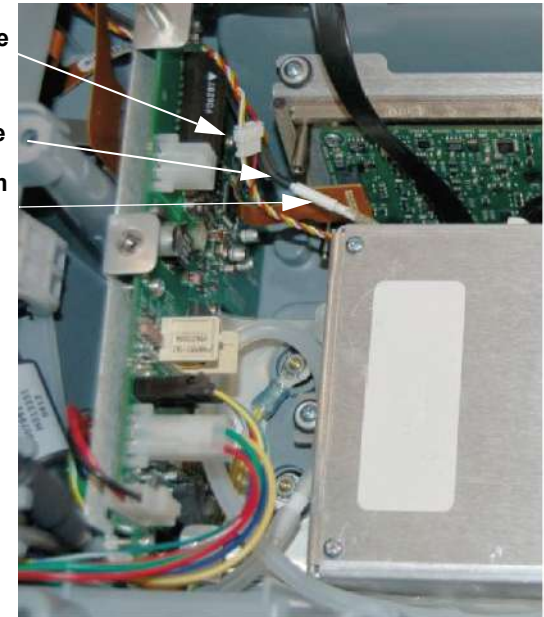

Figure 10.82—CO2 module connections

To remove the NIBP and CO2 modules as a unit from the rear case: *(Continued) 17 steps, (Page 3 of 4)*

11. For the NIBP option disassembly, remove the NIBP cable (W27) from cable guide on bracket cover.
12. Remove the four screws (202253-760) from the bracket cover (3206965-001) and lift off the cover. Discard the screws.
13. To remove the NIBP sub-assembly (3206268), remove the four screws (202253-760) and lift the assembly off the OEM bracket. Discard the screws.
14. Disconnect the OEM PCB/NIBP module cable (W27) from the A21 NIBP PCB at J2.

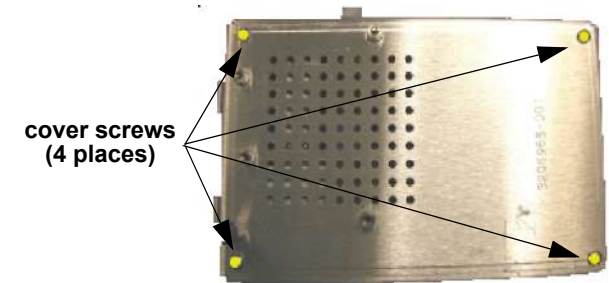

Figure 10.83—Bracket cover screw locations

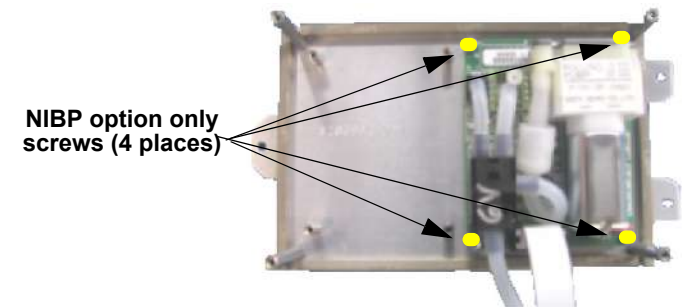

Figure 10.84—NIBP sub-assembly screw locations

To remove the NIBP and CO2 modules as a unit from the rear case: *(Continued) 17 steps, (Page 4 of 4)*

15. To remove the CO2 sub-assembly (3012140-006), remove the four screws (202253-760) and lift the assembly off the OEM bracket. Discard the screws.
16. Disconnect the OEM PCB/CO2 module cable from the CO2 PCB (A23) at J4.
17. Disconnect the CO2 adapter cable from the CO2 PCB (A23) at J1.

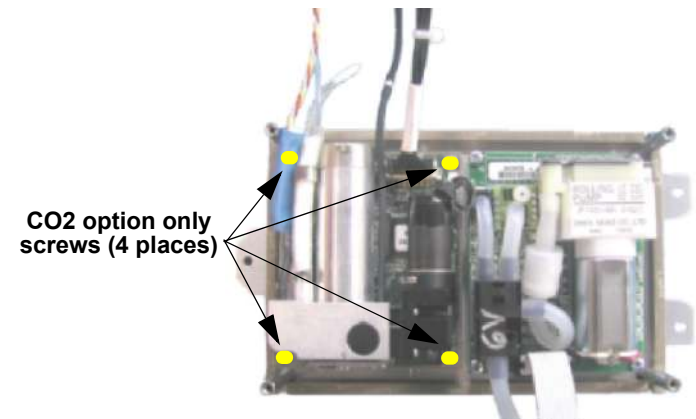

Figure 10.85—CO2 sub-assembly screw locations

### CAUTION

**POSSIBLE SKIN BURNS** Do not open the CO2 scrubber device (part of the CO2 module). Scrubber material may cause caustic burns. If scrubber material comes in contact with skin, rinse the area of contact thoroughly with water. If scrubber material comes in contact with eyes, flush eyes with water for 15 minutes, and then seek immediate medical attention.



### Installing the NIBP (A21)/CO2 (A23) Modules

◆ To install the A21 NIBP, A23 CO2, and SpO2 PCBs: *12 steps, (Page 1 of 6)*

1. For NIBP option:

**NOTE:** When replacing the NIBP module, use [NIBP Module Repair Kit \(MIN 3305431-000\)](#) (p. 612).

- a. Attach the NIBP module sub-assembly ([3206268](#)) to the OEM bracket ([3206965-001](#)) with four new screws ([202253-760](#)); torque to 4 in-lb.
- b. Connect the OEM PCB/NIBP module cable to the A21 NIBP PCB at J2.
- c. Route cable and tubing as shown and ensure that the cable and tubing are not pinched.
- d. Connect the NIBP hose from the module to the inlet fitting. Route excess tubing as shown. Ensure that the NIBP tubing is routed through the hole in the bracket cover.

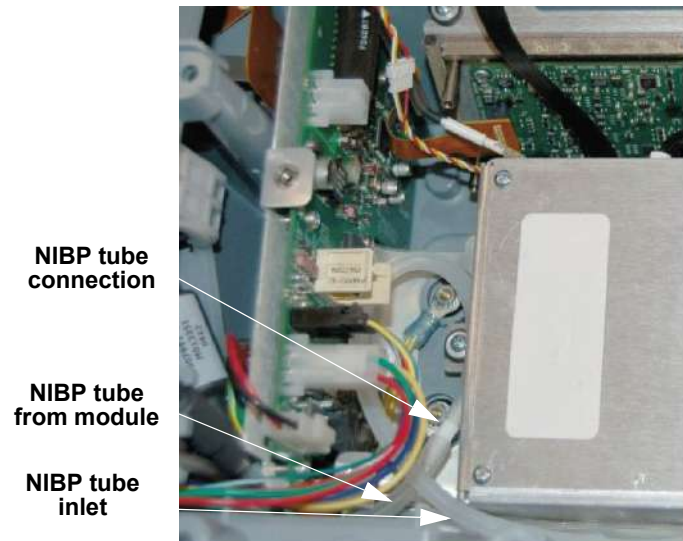
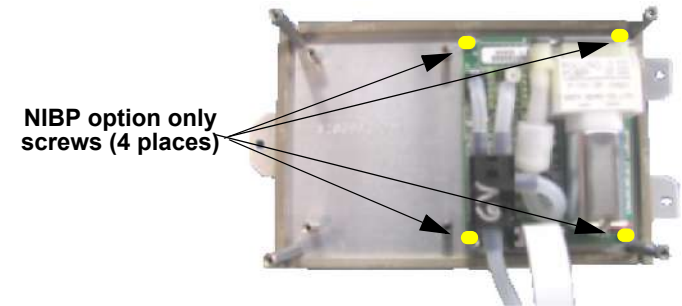

Figure 10.86—NIBP module



◆ To install the A21 NIBP, A23 CO2, and SpO2 PCBs: *(Continued) 12 steps, (Page 2 of 6)*

2. For CO2 option:

**NOTE:** When replacing the CO2 module, use [CO2 Module Repair Kit \(MIN 3305431-002\)](#) (p. 614).

- a. Attach the CO2 module ([3012140-006](#)) to the mounting bracket with four new screws ([202253-760](#)); torque to 4 in-lb.
- b. Connect the OEM PCB/CO2 module cable (W26) to the A23 CO2 PCB at J4.
- c. Connect the CO2 adapter cable (W30) to the A23 CO2 PCB at J1.

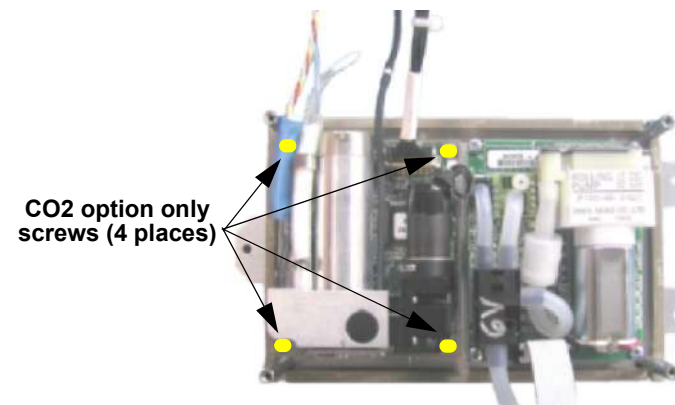

Figure 10.87—CO2 sub-assembly screw locations

- ◆ To install the A21 NIBP, A23 CO2, and SpO2 PCBs: *(Continued) 12 steps, (Page 3 of 6)*
  - d. Route the CO2 tubing and CO2 adapter cable as shown. Ensure that the cable and tubing are not pinched when installing the bracket cover.
- 3. Attach the bracket cover to the OEM bracket with four new screws ([202253-760](#)); torque to 4.0 in-lb.

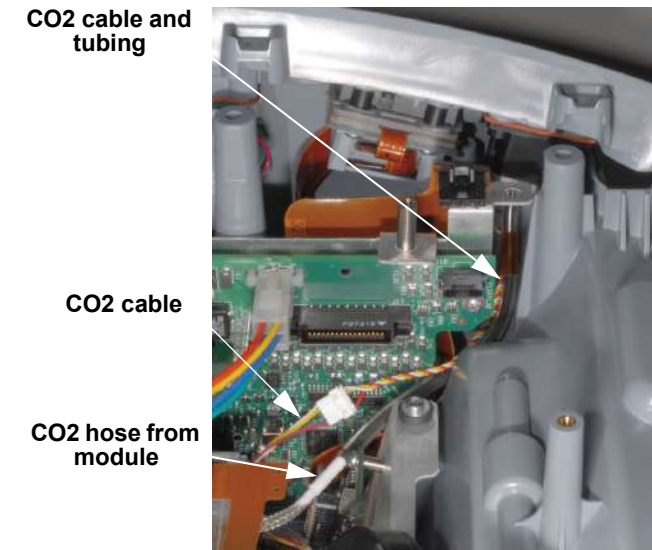

Figure 10.88—CO2 tubing and cable routing

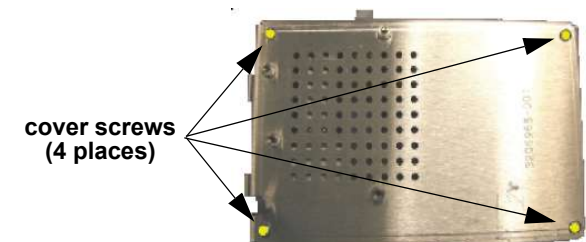

Figure 10.89—Bracket cover screw locations

- ◆ To install the A21 NIBP, A23 CO2, and SpO2 PCBs: *(Continued) 12 steps, (Page 4 of 6)*
  4. For the NIBP option, route the NIBP cable through the cable mount on side of bracket cover.
  5. Place the OEM bracket into rear case and secure with the three new mounting screws (3207337-312); torque to 6.8 in-lb.

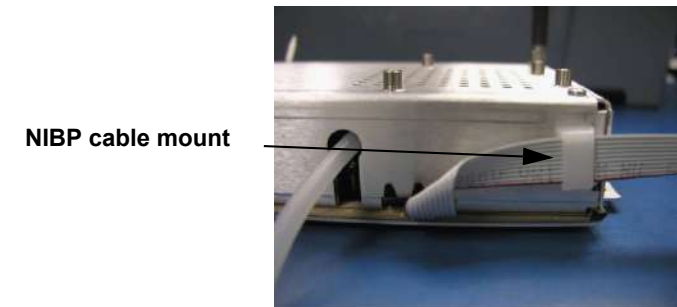

Figure 10.90—NIBP cable routing

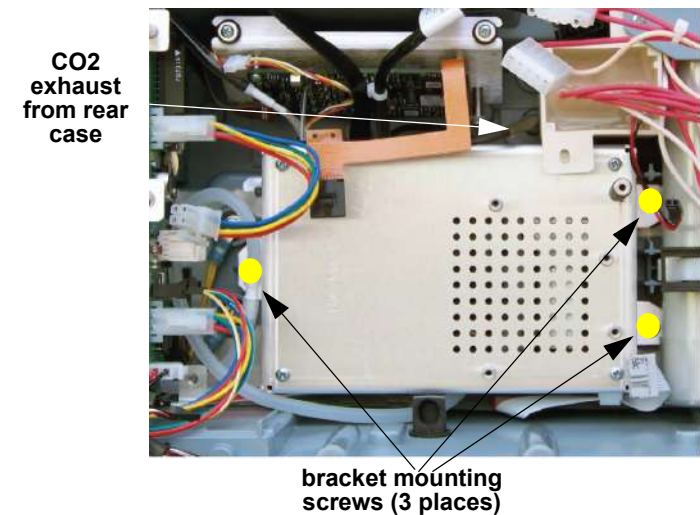

Figure 10.91—CO2/NIBP mounting bracket

- ◆ To install the A21 NIBP, A23 CO2, and SpO2 PCBs: *(Continued) 12 steps, (Page 5 of 6)*
  6. If present, connect CO2 module tube to CO2 inlet tube.  
**NOTE:** Older versions of the CO2 module have a Nafion inlet tube which can be pinched if pushed back into the CO2 module area. Keep the tube from the module stretched out while connecting the inlet tube.
  7. If present, connect CO2 inlet cable (W28) to CO2 adapter cable (W30).

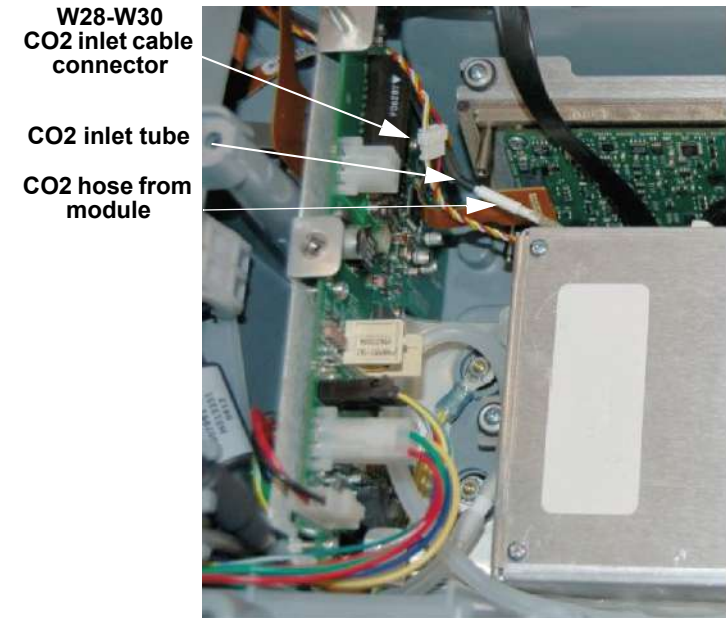

Figure 10.92—CO2 module connections

- ◆ To install the A21 NIBP, A23 CO2, and SpO2 PCBs: *(Continued) 12 steps, (Page 6 of 6)*
  8. If present, connect the exhaust tube to the rear case outlet connector.
  9. Install the OEM PCB as described in [Installing the OEM PCB \(A06\) \(p. 385\)](#).
  10. Install the transfer relay assembly as described in [Installing the Transfer Relay Assembly \(A13\) \(p. 390\)](#).
  11. Install the system/therapy PCB assembly as described in [System \(A01\)/Therapy \(A04\) PCB Assembly Replacement \(p. 352\)](#).
  12. Reassemble the case as described in [Reassembling the Case \(p. 304\)](#).

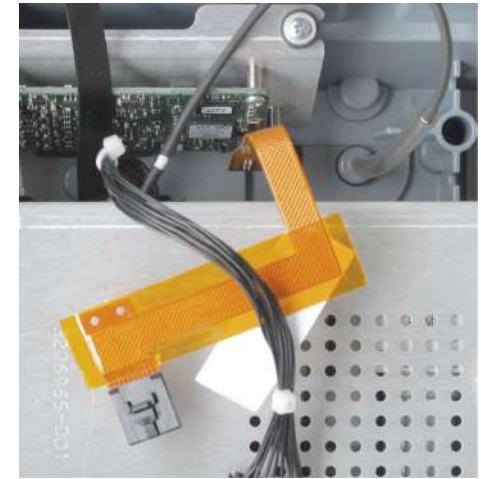

Figure 10.93—CO2 exhaust tube connection

### Biphasic Module (A22)/Inductive Resistor (A14) Replacement

Biphasic module inductive resistor replacement consists of the following procedures:

- [Removing the Biphasic Module \(A22\)/Inductive Resistor \(A14\) \(p. 419\)](#)
- [Installing the Biphasic Module \(A22\)/Inductive Resistor \(A14\) \(p. 422\)](#)

### Removing the Biphasic Module (A22)/Inductive Resistor (A14)

- ◆ To remove the biphasic module and/or the inductive resistor from the rear case (refer to [Inside Rear Case Diagrams \(p. 348\)](#)):

*12 steps, (Page 1 of 3)*

1. Disassemble the case as described in [Disassembling the Case \(p. 301\)](#).
2. Remove the system/therapy PCB assembly as described in [System \(A01\)/Therapy \(A04\) PCB Assembly Replacement \(p. 352\)](#).
3. Remove the screw (202253-761) securing the clear, plastic, high-voltage shield (3010593-00) to the interconnect bracket (A17). Discard the screw.

#### DANGER

**SHOCK HAZARD** Lethal voltages may be present even without operator action. Always discharge the energy storage capacitor prior to servicing. See the service manual "[Capacitor Discharging Procedure \(p. 298\)](#)" for detailed instructions.

4. Cut the two cable ties on the right side of the interconnect bracket.
5. Disconnect the three biphasic module spade terminal connectors from the interconnect bracket (A17 - pin 3, pin 6, and pin 9). Needle nose pliers may be used to assist in disconnection.

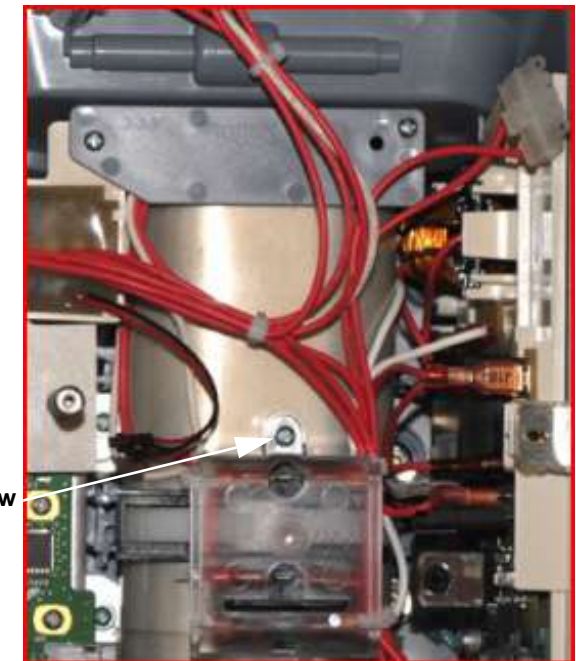

cover screw

Figure 10.94—Interconnect bracket screw locations



- ◆ To remove the biphasic module and/or the inductive resistor from the rear case (refer to [Inside Rear Case Diagrams \(p. 348\)](#)):

*(Continued) 12 steps, (Page 2 of 3)*

6. Remove the two biphasic module mounting screws (3207337-312). Discard the screws.
7. Lift the biphasic bracket up slightly to gain access to connector. Disconnect the red transfer relay lead spade connector from the biphasic modular assembly at J104. Needle nose pliers may be used to assist in disconnection.
8. Remove the bracket (3011589-004) with the biphasic PCB (3010178-010) and inductive resistor (3010212-02) from the rear case.
9. The inductive resistor (3010212-02) can be removed from the bracket prior to removing the biphasic PCB from the bracket. To remove the inductive resistor from the bracket disconnect the two spade terminal connectors at J102 and J108 of the biphasic PCB. Remove two screws (3207337-312) from the biphasic bracket, lift the mounting tabs, and lift the inductive resistor from the assembly. Discard the screws.
10. To continue removing the biphasic PCB, remove the screw (3207337-312) and ground strap (3012345-00) from the PCB. Discard the screw.

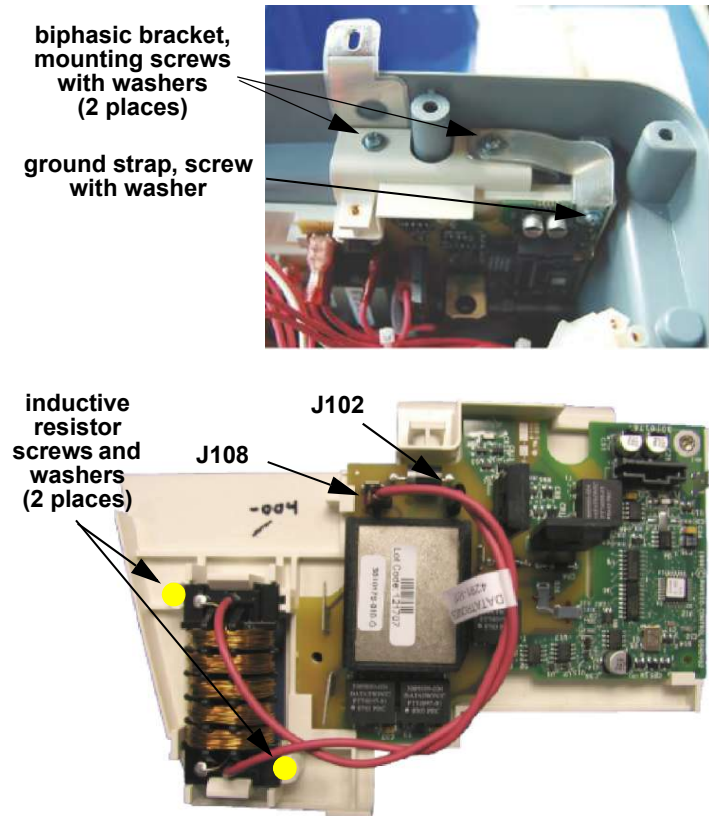

Figure 10.95—Biphasic bracket and inductive resistor



- ◆ To remove the biphasic module and/or the inductive resistor from the rear case (refer to [Inside Rear Case Diagrams \(p. 348\)](#)):  
(Continued) 12 steps, (Page 3 of 3)

11. Continue to remove the biphasic PCB from the bracket as follows:
  - a. Orient the PCB bracket as shown in the diagram (with the mounting tabs on top and one PCB mounting hole in the upper right corner).
  - b. Slide the PCB to the right slightly.
  - c. Rotate the PCB counterclockwise to clear the tab at the lower right corner.
  - d. Pull the PCB to the right as you lift it out.
12. Remove the remaining spade terminal wires for use on the replacement module.

### Installing the Biphasic Module (A22)/Inductive Resistor (A14)

◆ To install the biphasic PCB and inductive resistor: 16 steps (Page 1 of 3)

**NOTE:** When replacing the Biphasic module, use [Biphasic Module Repair Kit \(MIN 3305431-011\)](#) (p. 621).

1. Mount the biphasic PCB (3010178-010) to the biphasic bracket (3011589-004). Tilt the PCB to get into the bracket slots. (Do not bend the PCB).
2. Wrap the inductive resistor (3010212-02) wires together three or four turns and connect to the biphasic PCB at J102 and J108. Ensure that the twisted wires are routed below and around CR7.
3. (If removed) Clip the inductive resistor (3010212-02) into the biphasic bracket with the wires exiting away from the bracket.
4. Install the wire harness (3011979-02) marked J105 to the biphasic PCB at J105.
5. Install the wire harness (3011979-00) marked J103 to the biphasic PCB at J103.
6. Install the wire harness (3011979-01) marked J101 to the biphasic PCB at J101.
7. If inductive resistor was removed: Install two new screws with washer (3207337-312) into the bracket securing the inductive resistor in place; torque to 4.0 in-lb.

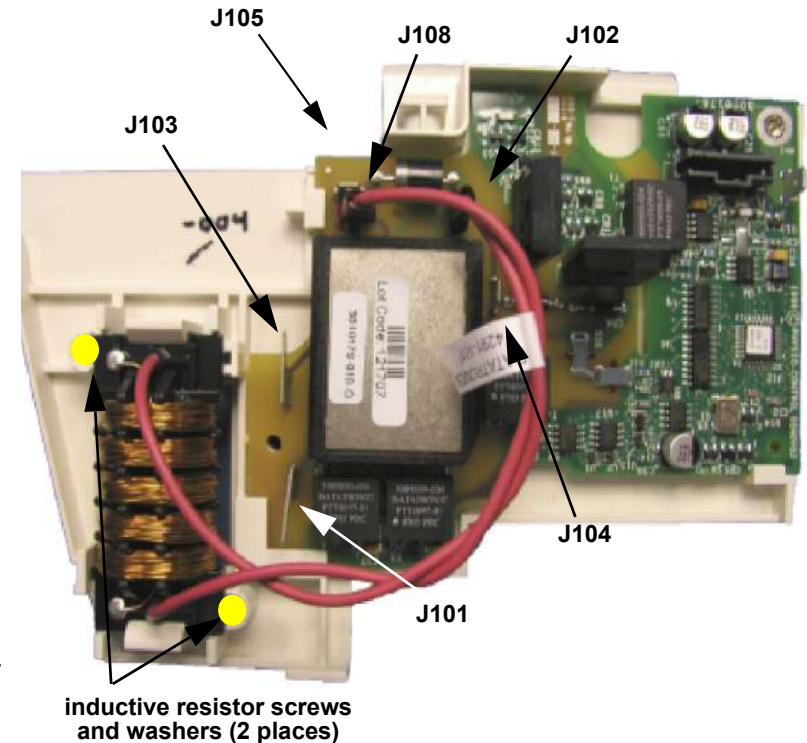

Figure 10.96—Biphasic PCB installation

- ◆ To install the biphasic PCB and inductive resistor: *(Continued) 16 steps (Page 2 of 3)*
  8. Insert one new screw with washer (3207337-312) through the ground strap (3012345-00) and install through the biphasic PCB and bracket; torque to 6.8 in-lb.
  9. Place the biphasic bracket into the rear case but do not completely install. Leave the bracket up slightly for access to J104 connector. Connect the red transfer relay lead spade connector to the biphasic modular assembly at J104. Seat the biphasic bracket into the rear case.
  10. Route EMI shield tab over the biphasic PCB bracket. Route ground strap over EMI shield tab.
  11. Secure the biphasic PCB bracket into the rear case with two new screws with washer (3207337-312); torque to 6.8 in-lb.

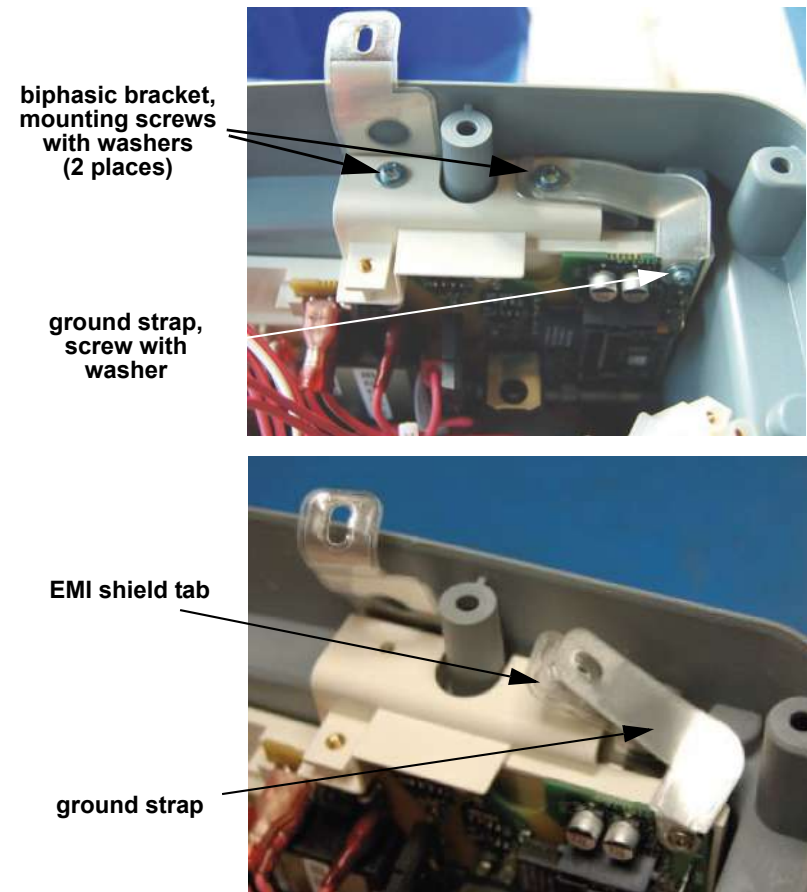

Figure 10.97—Biphasic bracket mounting

- ◆ To install the biphasic PCB and inductive resistor: *(Continued) 16 steps (Page 3 of 3)*
  12. Install two cable ties to the right side of the interconnect bracket (A17).
  13. Install one new screw ([202253-761](#)) securing the clear, plastic, high-voltage shield ([3010593-00](#)) to the interconnect bracket (A17); torque to 6.8 in-lb.
  14. Replace the system/therapy PCB assembly as described in [System \(A01\)/Therapy \(A04\) PCB Assembly Replacement \(p. 352\)](#).
  15. Reassemble the case as described in [Reassembling the Case \(p. 304\)](#).
  16. After device reassembly, complete the TCP – Defibrillator Calibration procedure (see [TCP – Defibrillator Energy Calibration \(p. 200\)](#)). The defibrillator calibration constants may be invalidated when you replace Defibrillator Energy delivery components.

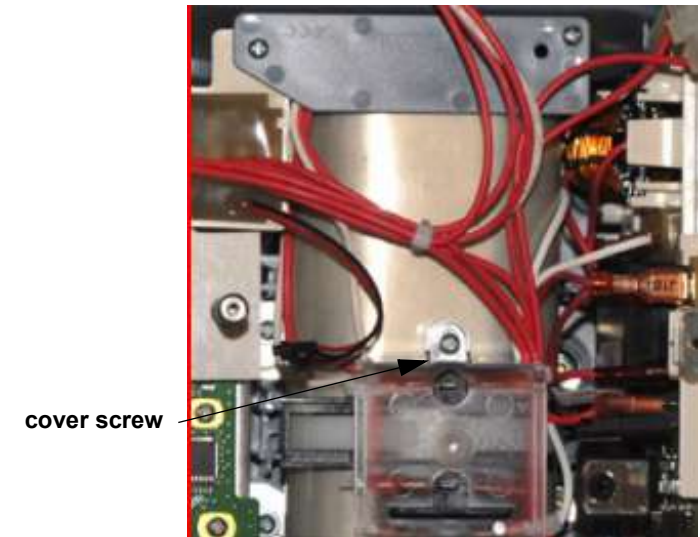

Figure 10.98—High voltage shield

### EMI Shield Replacement

- ◆ The shield is supplied as part of the rear case. Follow the instructions in the [Battery Pins / Power PCB Cable \(W10\) Replacement \(p. 454\)](#) procedure to remove the EMI shield (3206960-002).



**Figure 10.99—EMI shield and battery wire harness nut locations**

- ◆ To install the EMI shield, reverse the steps in the [Rear Case Replacement \(p. 435\)](#) procedure, using the following guidelines.
  1. Clean with alcohol in the area where the EMI shield adhesive contacts case.
  2. Pre-fold EMI case shield by placing the shield into the rear case.
  3. Remove adhesive liners and secure EMI shield with Adhesive patches to case.
  4. To complete EMI shield installation, follow the steps described in [Installing the Battery Pins/Power PCB Cable \(W10\) \(p. 456\)](#).

### NIBP Connector Replacement

NIBP connector replacement consists of the following procedures:

- [Removing the NIBP Connector \(p. 427\)](#)
- [Installing the NIBP Connector \(p. 428\)](#)

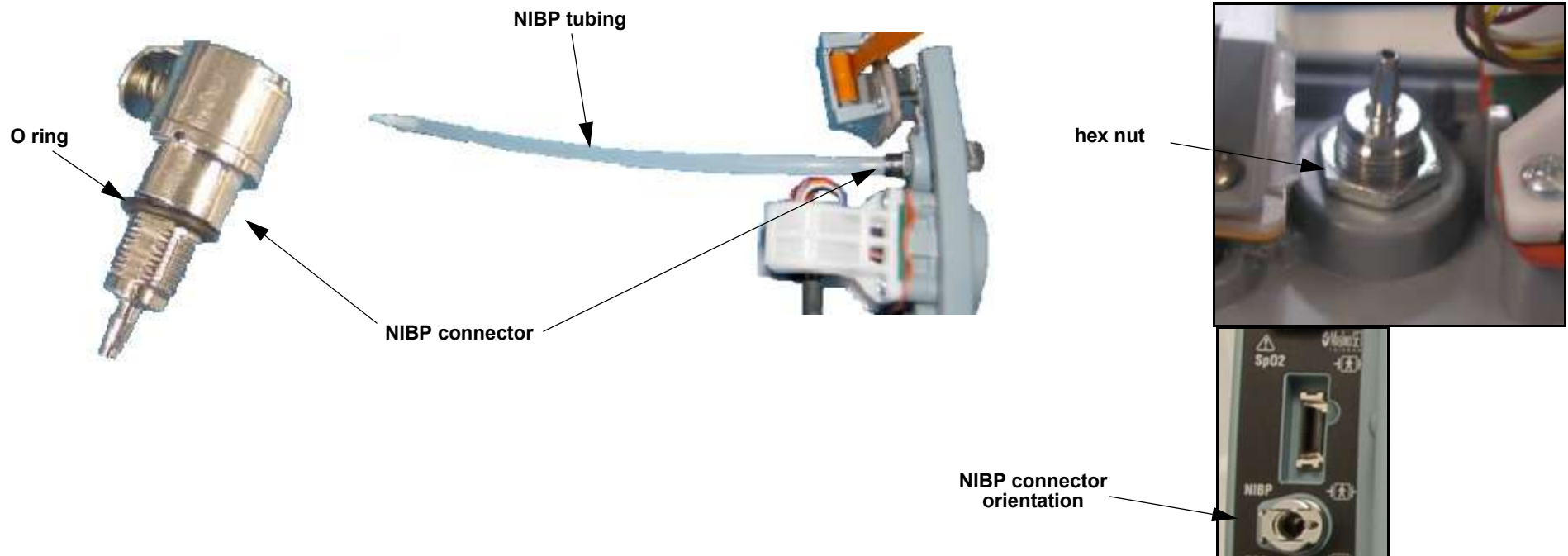

Figure 10.100—NIBP connector and nut location

### Removing the NIBP Connector

Refer to [Figure 10.100 on p. 426](#).

- ◆ To remove the NIBP connector from the parameter bezel (rear case—refer to [Inside Rear Case Diagrams \(p. 348\)](#)):

**NOTE:** These steps include all parameter bezel options. Your device may not have some of these options.

1. Disassemble the case as described in [Disassembling the Case \(p. 301\)](#).
2. Remove the system/therapy PCB assembly as described in [System \(A01\)/Therapy \(A04\) PCB Assembly Replacement \(p. 352\)](#).
3. Remove the parameter bezel as described in [Removing the Parameter Bezel \(p. 431\)](#).
4. Remove the NIBP tube ([3012180-02](#)) from the NIBP connector ([3207033-001](#)).
5. Remove the fitting nut on the back side of the bezel to remove the connector ([3207033-001](#)).
6. Remove the NIBP connector from the bezel.



### Installing the NIBP Connector

Refer to [Figure 10.100 on p. 426](#).

- ◆ To install the NIBP connector into the parameter bezel (rear case—refer to [Inside Rear Case Diagrams \(p. 348\)](#)):
  - NOTE:** When installing a new NIBP connector, use [NIBP Connector Repair Kit \(MIN 3305431-022\) \(p. 627\)](#).
  - 1. Install the connector ([3207033-001](#)) by installing the fitting nut on the back side of the bezel. Ensure the O ring seal is on the NIBP connector (torque to 10.0 in-lb using a 1/2" deep socket) (see [Figure 11.11 on p. 513](#) for NIBP connector orientation).
  - 2. Connect the NIBP tube ([3012180-02](#)) to the NIBP connector ([3207033-001](#)).
    - NOTE:** If the NIBP tube has been previously disconnected/reconnected from the fitting, the tube end should be trimmed to maintain an airtight seal.
  - 3. Install the parameter bezel as described in [Installing the Parameter Bezel \(p. 433\)](#).
  - 4. Install the system/therapy PCB assembly as described in [Installing the System \(A01\)/Therapy \(A04\) PCB Assembly \(p. 359\)](#).
  - 5. Reassemble the case as described in [Reassembling the Case \(p. 304\)](#).



### Parameter Bezel Replacement

Parameter Bezel replacement consists of the following procedures:

- [Removing the Parameter Bezel \(p. 431\)](#)
- [Installing the Parameter Bezel \(p. 433\)](#)

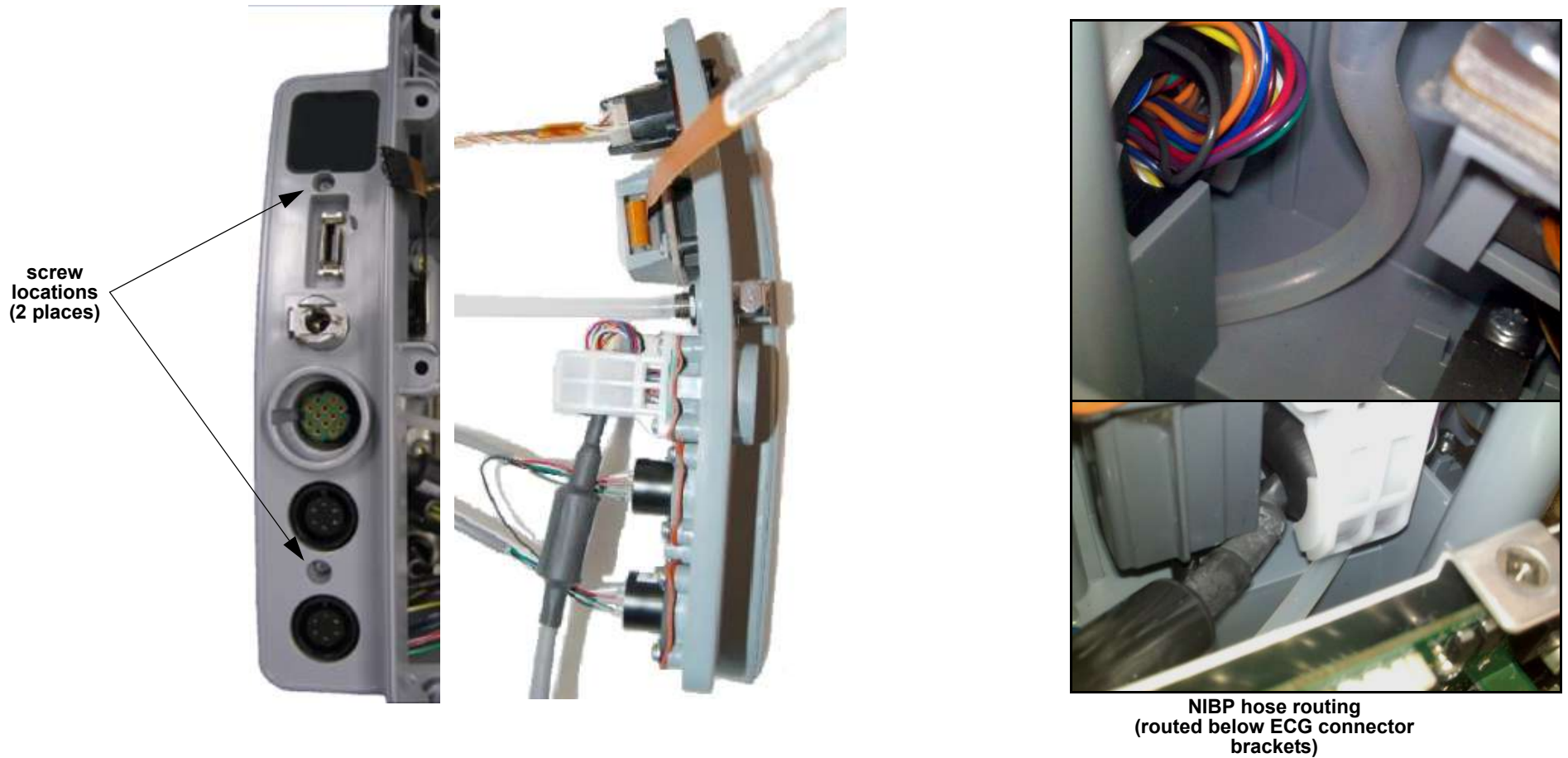

Figure 10.101—Parameter bezel component orientations

### Removing the Parameter Bezel

Refer to [Figure 11.10 on p. 512](#), [Figure 11.11 on p. 513](#), and [Figure 11.12 on p. 514](#).

**NOTE:** This procedure includes the OEM PCB and all options on the parameter bezel. Skip the steps pertaining to options your device does not have.

**NOTE:** To remove cables from the parameter bezel, select the appropriate cable replacement procedure from the [Summary of Replacement Procedures \(p. 290\)](#) (for example, SpO2 Cable).

- ◆ To remove the parameter bezel from the rear case:
  1. Disassemble the case as described in [Disassembling the Case \(p. 301\)](#).
  2. Remove the system/therapy PCB assembly as described in [Removing the System \(A01\)/Therapy \(A04\) PCB Assembly \(p. 353\)](#).
  3. Remove the OEM PCB as described in [Removing the OEM PCB \(A06\) \(p. 382\)](#).
  4. Disconnect the power/contact PCB (W05) from the power board at J12 (see [Figure 10.52 on p. 375](#)).
  5. Remove the power/system cable (W01) from the power board at J17.
  6. If present, disconnect the CO2 inlet tube.
  7. If present, carefully disconnect the CO2 cable connector (W28) from CO2 adapter cable (W30).
  8. If present, disconnect the NIBP tube at tube fitting.
  9. If present, carefully disconnect the SpO2 connector flex cable (W22) ([3206995-004](#)) from J1 of the SpO2 PCB.

### CAUTION

**POSSIBLE COMPONENT DAMAGE** The SpO2 connector flex cable can be damaged during disassembly. If SpO2 connector is damaged, replace the SpO2 flex cable using the [MASIMO SpO2 Panel Mount Cable Repair Kit \(MIN 3305431-026\) \(p. 631\)](#) kit.

10. If present, remove the CO2 door.
11. Remove the parameter bezel label from the bezel.
12. Remove the two bezel mounting screws ([202253-763](#)). Discard the screws.
13. Lift out the parameter bezel ([3206723-005](#)) from the rear case.

### Installing the Parameter Bezel

#### CAUTION

**POSSIBLE MOISTURE LEAKAGE** Visually inspect the mating surfaces between the parameter bezel and the rear case before and after fastening to ensure that they are even.

- ◆ To install the parameter bezel: *15 steps, (Page 1 of 2)*

**NOTE:** When installing the parameter bezel (3206723-005) as a stand-alone repair, use the [External Hardware Repair Kit \(MIN 3305431-016\)](#) (p. 624).

Observe the following:

- Clean away any adhesive residue on the parameter bezel with isopropyl alcohol.
  1. If you are installing a new parameter bezel, transfer the following items from the old parameter bezel to the new parameter bezel, as they apply to your device.
    - ~ ECG connector cable (use a new seal)—[ECG Connector Cable \(W07\) Replacement](#) (p. 448)
    - ~ SpO2 connector cable—[SpO2 Connector Cable \(W22\) Replacement](#) (p. 464)
    - ~ NIBP connector O-ring nut—[NIBP Connector Replacement](#) (p. 426)
    - ~ CO2 inlet connector cable (use a new seal)—[CO2 Inlet Connector Cable \(W28\) Replacement](#) (p. 470)
    - ~ Invasive Pressure connector (use new seals)—[Invasive Pressure Connector Assembly \(W33\) Replacement](#) (p. 475)
    - ~ Temperature connector cable—[Temperature Cable Assembly \(W35\) Replacement](#) (p. 477)
  2. Place the parameter bezel above the rear case to make the cable connections.

- ◆ To install the parameter bezel: *(Continued) 15 steps, (Page 2 of 2)*
- 3. If present, route NIBP tube ([3012180-02](#)) through opening in power PCB bracket next to the J9 connector, power PCB. Connect the NIBP tube to the NIBP connector fitting ([3207033-001](#)) and ensure that it is fully seated.
- 4. If present, connect the SpO2 connector cable (W22) to SpO2 PCB (A16) at JP1.
- 5. If present, connect the CO2 inlet tube (W28) to the barbed fitting connected to the CO2 module (A23).
- 6. If present, connect the CO2 connector cable end (W28) to the CO2 adapter cable (W30).
- 7. Reinstall the parameter bezel onto rear case with two new screws ([202253-763](#)); torque to 6.8 in-lb.

**NOTE: Ensure the NIBP hose isn't pinched by the ECG Brackets or rear case standoff. NIBP hose movement should be unrestricted in bezel cavity** (see [Figure 10.101 on p. 430](#)).

- 8. Devices without CO2: Place a label spacer ([3207407-000](#)) into the CO2 recess in the bezel before applying the label.
- 9. Connect the power/contact PCB cable (W05) to the power PCB (A03) at J12 (see [Figure 10.56 on p. 378](#)).
- 10. Connect the power/system cable (W01) to the power PCB (A03) at J17 (see [Figure 10.58 on p. 380](#)).
- 11. Install the OEM PCB as described in [Installing the OEM PCB \(A06\) \(p. 385\)](#).
- 12. Install the system/therapy PCB assembly as described in [System \(A01\)/Therapy \(A04\) PCB Assembly Replacement \(p. 352\)](#).
- 13. Reassemble the case as described in [Reassembling the Case \(p. 304\)](#).
- 14. Use a new parameter bezel label. Apply the parameter bezel label (#1) from the label set ([3207318-XXX](#)) to the bezel front. Press the label down firmly.
- 15. If CO2 is present, install the CO2 cover ([3207407-000](#)) onto the CO2 adapter.

### Rear Case Replacement

Rear case replacement consists of the following procedures:

- [Removing the Rear Case \(p. 436\)](#)
- [Installing the Rear Case \(p. 438\)](#)

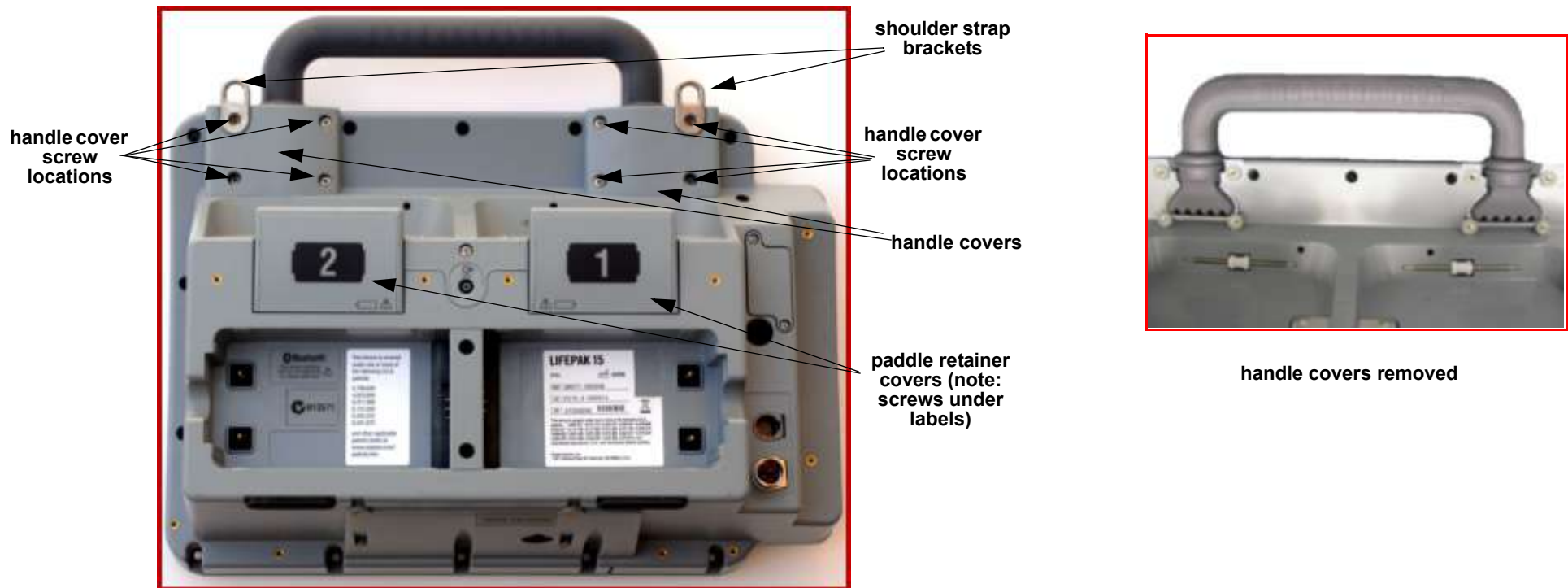

Figure 10.102—Rear case replacement screw locations

### Removing the Rear Case

- ◆ To remove the rear case: *17 steps, (Page 1 of 2)*
  1. Disassemble the case as described in [Disassembling the Case \(p. 301\)](#).
  2. Remove the system/therapy PCB assembly as described in [System \(A01\)/Therapy \(A04\) PCB Assembly Replacement \(p. 352\)](#).
  3. Remove the screw ([202253-761](#)) securing the clear, plastic, high-voltage shield ([3010593-00](#)) from the interconnect bracket (A17) (see [Figure 10.2 on p. 298](#)). Discard the screw.
  4. Remove the two mounting screws ([202253-761](#)) from the capacitor bracket and remove the bracket ([3207031-001](#)) (see [Figure 10.65 on p. 389](#)). Discard the screws.
  5. Remove the two biphasic module mounting screws ([3207337-312](#)) (see [Figure 10.95 on p. 420](#)). Discard the screws.
  6. Observing orientation, cut the large tie wrap securing the A15 energy storage capacitor and interconnect bracket to the rear case. Remove the energy storage capacitor, interconnect bracket, transfer relay and Biphasic module assembly **without removing small cable ties and spade terminal connections**.
  7. Remove the OEM PCB as described in [Removing the OEM PCB \(A06\) \(p. 382\)](#).
  8. Remove the parameter bezel as described in [Removing the Parameter Bezel \(p. 431\)](#).
  9. Remove the NIBP/CO2 module as described in [Removing the NIBP \(A21\)/CO2 \(A23\) Modules \(p. 408\)](#). (Removing the bracket cover in this procedure is not required.)
  10. Remove the SpO2 module as described in [Removing the SpO2 PCB \(A16\) \(p. 395\)](#) (if installed).
  11. Remove the power PCB as described in [Removing the Power PCB \(A03\) \(p. 374\)](#).
  12. Remove the contact PCB as described in [Removing the Contact PCB \(A07\) \(p. 479\)](#).
  13. Remove the system connector cable and auxiliary connector cable as described in [Removing the System Connector Cable \(W08\) or Auxiliary Power Cable \(W09\) \(p. 452\)](#) (use new O-ring seals ([200060-011](#)) during installation).



- ◆ To remove the rear case: *(Continued) 17 steps, (Page 2 of 2)*
- 14. Disconnect the battery pins/power PCB cable (W10) ([3207692-000](#)) from the rear case by removing the four Kep nuts ([201508-000](#)) (see [Figure 10.99 on p. 425](#)). Reuse the Kep nuts.
- 15. Remove the CO2 exhaust ([3012140-002](#)) from the rear case (if installed).
- 16. Remove the USB flex assembly as described in [Removing the W14 - USB Flex Module \(p. 459\)](#)
  - ~ Remove the drain seal ([3006291-00](#)) from the rear case.
- 17. Remove the handle as described in [Removing the Handle \(p. 441\)](#).

### Installing the Rear Case

- ◆ To install the rear case: *23 steps, (Page 1 of 3)*
- When replacing the Rear Case, use [Rear Case Repair Kit \(MIN 3305431-024\)](#) (p. 629).
- Clean adhesive areas with alcohol.

Transfer the following parts from the old rear case to the new rear case:

1. Install handle ([3207706-000](#)), handle covers and shoulder straps as described in [Handle Replacement](#) (p. 441).  
**NOTE:** If a new handle is required, use [Handle Repair Kit \(MIN 3305431-020\)](#) (p. 626).
2. Install the drain seal ([3006291-00](#)) into the rear case.
3. Install the CO2 exhaust tubing ([3012140-002](#)) onto rear case (if CO2 option).
4. Install the contact PCB as described in [Installing the Contact PCB \(A07\)](#) (p. 479).
5. Install the system connector and auxiliary connector cables as described in [Installing the System Connector Cable \(W08\)](#) or [Auxiliary Power Cable \(W09\)](#) (p. 453) using new O-ring seals ([200060-011](#)).
6. Install the EMI shield ([3206960-002](#)) as described in [EMI Shield Replacement](#) (p. 425) (new part from repair kit).
7. Install the battery pins/power PCB cable (W10) ([3207692-000](#)) as described in [Installing the Battery Pins/Power PCB Cable \(W10\)](#) (p. 456).
8. Install the power to contact PCB cable (W05) ([3207261-001](#)) to J42 of the contact PCB.
9. Install the USB flex assembly as described in [USB Flex Module \(W14\) Replacement](#) (p. 458).

- ◆ To install the rear case: *(Continued) 23 steps, (Page 2 of 3)*
  10. Install four battery pins as described in [Battery Pin Replacement \(p. 484\)](#) (new part from repair kit).
  11. Secure the energy storage capacitor and interconnect bracket to the rear case using a large cable tie ([200536-001](#)). Place the bottom of energy storage capacitor flush to the rear case.
  12. Route the energy storage capacitor wires along left side of capacitor body.  
**NOTE:** Place transfer relay on top of the energy storage capacitor until further in the reassembly process.
  13. Install the biphasic PCB as described in [Installing the Biphasic Module \(A22\)/Inductive Resistor \(A14\) \(p. 422\)](#).
  14. Install the parameter bezel as described in [Installing the Parameter Bezel \(p. 433\)](#).
  15. Install the power PCB as described in [Installing the Power PCB \(A03\) \(p. 377\)](#).
  16. If option is present, install the SpO2 module as described in [Installing the SpO2 PCB \(A16\) \(p. 400\)](#).
  17. Install the NIBP/CO2 Module housing as described in [Installing the NIBP \(A21\)/CO2 \(A23\) Modules \(p. 412\)](#).
  18. Install the transfer relay assembly as described in [Installing the Transfer Relay Assembly \(A13\) \(p. 390\)](#).
  19. Install the OEM PCB as described in [Installing the OEM PCB \(A06\) \(p. 385\)](#).
  20. Install the system/therapy PCB assembly as described in [System \(A01\)/Therapy \(A04\) PCB Assembly Replacement \(p. 352\)](#).
  21. Reassemble the case as described in [Reassembling the Case \(p. 304\)](#).

- ◆ To install the rear case: *(Continued) 23 steps, (Page 3 of 3)*
- 22. Install the SpO2 patent label ([3207359-000](#)) in battery well 2 (if SpO2 option is present).
- 23. When installing the rear case, install the following NEW labels:
  - ~ Battery well 2 cover label, see label set ([3207318-XXX](#)), label # 9
  - ~ Battery well 1 cover label, see label set ([3207318-XXX](#)), label # 8
  - ~ Bluetooth label, see label set ([3207318-XXX](#)), label # 12
  - ~ Capacitor mount cover label, see label set ([3207318-XXX](#)), label # 2
  - ~ CO2 cover label, see label set ([3207318-XXX](#)), label # 7
  - ~ Sys/Aux connector label, see label set ([3207318-XXX](#)), label # 3
  - ~ FDA label, see label set ([3207318-XXX](#)), label # 5
  - ~ Serial number label ([3207131](#)) (special order required, contact Physio-Control technical services)

### Handle Replacement

Handle replacement consists of the following procedures:

- [Removing the Handle \(p. 441\)](#)
- [Installing the Handle \(p. 441\)](#)

#### Removing the Handle

- ◆ To remove the handle:
  1. Remove the four screws ([201407-069](#)) for each handle cover. Discard the screws.
  2. Remove the left and right shoulder strap brackets ([3207708-000](#)).
  3. Remove the left ([3207707-000](#)) and right ([3207746-000](#)) handle covers.
  4. Remove the handle ([3207706-000](#)).

#### Installing the Handle

- ◆ To install the handle:
  1. Place the handle ([3207706-000](#)) in the slots of the case. (Note that the front side of the handle has the triangular indentation.)
  2. Attach the left ([3207707-000](#)) and right ([3207746-000](#)) handle covers to the rear case using six new screws ([201407-069](#)); torque to 10 in-lb using a P2 bit.
  3. Install the shoulder strap brackets ([3207708-000](#)) using two new screws ([201407-069](#)); torque to 10 in-lb using a P2 bit.



Figure 10.103—Handle replacement

### Paddle Retainer Cover Replacement

Paddle retainer cover replacement consists of the following procedures:

- [Removing the Paddle Retainer Covers](#) (p. 442)
- [Installing the Paddle Retainer Covers](#) (p. 442)

#### Removing the Paddle Retainer Covers

- ◆ To remove the paddle retainer covers ([3006766-003](#)):
  1. Remove the two labels (number 1 and number 2) from the covers.
  2. Remove the six screws ([201407-069](#)) (three on each of the left and right covers). Discard the screws.
  3. Remove the left and right retainer covers ([3006766-003](#)).

#### Installing the Paddle Retainer Covers

- ◆ To install the paddle retainer covers ([3006766-003](#)):

**NOTE:** When installing the paddle retainer covers, use [Paddle Retainer Repair Kit \(MIN 3305431-017\)](#) (p. 625).

1. Install the left and right retainer covers using six new screws ([201407-069](#)); torque to 10 in-lb using a P2 bit.
2. Apply the new cover labels (#8 and #9) from the label set ([3207318-XXX](#)).

**NOTE:** Label #8 (displaying the number 1) goes to the right as you view the rear case.

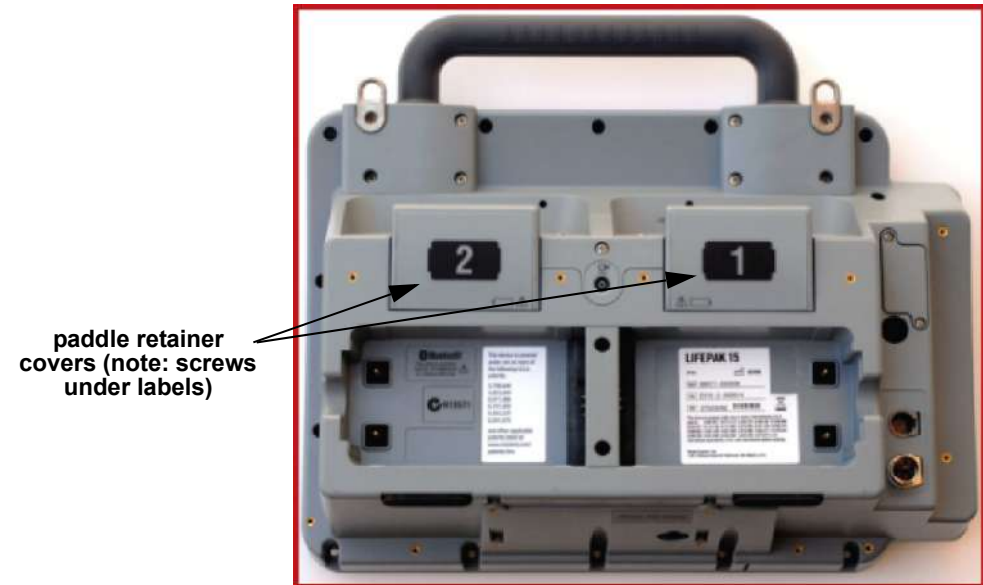

Figure 10.104—Paddle retainer cover locations

### Power/System PCB Cable (W01) Replacement

Power/system PCB cable replacement consists of the following procedures:

- [Removing the Power/System PCB Cable \(W01\)](#) (p. 443)
- [Installing the Power/System PCB Cable \(W01\)](#) (p. 443)

#### Removing the Power/System PCB Cable (W01)

- ◆ To remove the power/system PCB cable from the rear case (refer to [Inside Rear Case Diagrams](#) (p. 348)):
  1. Disassemble the case as described in [Disassembling the Case](#) (p. 301).
  2. Remove the system/therapy PCB assembly as described in [System \(A01\)/Therapy \(A04\) PCB Assembly Replacement](#) (p. 352).
  3. Remove the OEM shield ([3208298-000](#)).
  4. For orientation, locate power PCB-J17 on the rear case diagram. (The system PCB J1 end of the power/system PCB cable was disconnected as part of step 2.)
  5. Press the connector locking tabs, and then disconnect the power/system PCB cable from the power PCB (W03) at J17.

#### Installing the Power/System PCB Cable (W01)

- ◆ To install the power/system PCB cable into the rear case (refer to [Inside Rear Case Diagrams](#) (p. 348)):
  1. Connect the power/system PCB cable ([3207692-000](#)) to the power PCB (A03) at J17 (see [Figure 10.58](#) on p. 380).
  2. Install the OEM shield ([3208298-000](#)).
  3. Install the system/therapy PCB assembly (described in [System \(A01\)/Therapy \(A04\) PCB Assembly Replacement](#) (p. 352)).
  4. Reassemble the case as described in [Reassembling the Case](#) (p. 304).

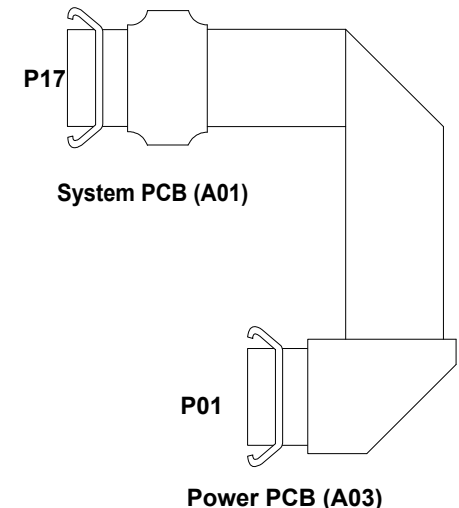

**Figure 10.105—Power/system PCB cable connections**

### Power/Therapy PCB Cable (W02) Replacement

Power/System PCB cable replacement consists of the following procedures:

- [Removing the Power/Therapy PCB Cable \(W02\) \(p. 445\)](#)
- [Installing the Power/Therapy PCB Cable \(W02\) \(p. 445\)](#)



### Removing the Power/Therapy PCB Cable (W02)

- ◆ To remove the power/therapy PCB cable from the rear case:
  1. Disassemble the case as described in [Disassembling the Case \(p. 301\)](#).
  2. Remove the system/therapy PCB assembly as described in [System \(A01\)/Therapy \(A04\) PCB Assembly Replacement \(p. 352\)](#).
  3. For orientation, locate power PCB-J8 on the rear case diagram. (The therapy PCB-J20 end of the power/therapy PCB cable was disconnected as part of step 2.)
  4. Press the connector locking tab, and then disconnect the power/therapy PCB cable at J8.

### Installing the Power/Therapy PCB Cable (W02)

- ◆ To install the power/therapy PCB cable into the rear case:
  1. Connect the power/therapy PCB cable ([3009726-01](#)) to the power PCB (A03) at J8.
  2. Install the system/therapy PCB assembly as described in [Installing the System \(A01\)/Therapy \(A04\) PCB Assembly \(p. 359\)](#).
  3. Reassemble the case as described in [Reassembling the Case \(p. 304\)](#).

to A04 Therapy PCB

P20

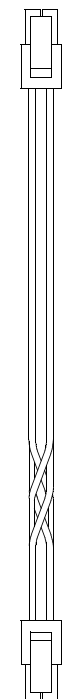

P08

to Power PCB (A03)

**Figure 10.106—Power/therapy PCB cable connections**

### Power/Contact PCB Cable (W05) Replacement

Power/contact PCB cable replacement consists of the following procedures:

- [Removing the Power/Contact PCB Cable \(W05\)](#) (p. 446)
- [Installing the Power/Contact PCB Cable \(W05\)](#) (p. 447)

#### Removing the Power/Contact PCB Cable (W05)

- ◆ To remove the power/contact PCB cable ([3207261-001](#)) from the rear case:
  1. Disassemble the case as described in [Disassembling the Case](#) (p. 301).
  2. Remove the system/therapy PCB assembly as described in [System \(A01\)/Therapy \(A04\) PCB Assembly Replacement](#) (p. 352).
  3. Disconnect the power/contact PCB cable from the power PCB at J12 (may be labeled P12).
  4. Remove the transfer relay as described in [Removing the Transfer Relay Assembly \(A13\)](#) (p. 389).

**NOTE:** It is not necessary to remove the spade terminals as described in the procedure.
  5. Remove the OEM PCB as described in [Removing the OEM PCB \(A06\)](#) (p. 382).
  6. Remove the NIBP/CO2 assembly as described in [Removing the NIBP \(A21\)/CO2 \(A23\) Modules](#) (p. 408).
  7. Disconnect the power/contact PCB cable at J42 of the contact PCB (A07).
  8. Remove the power/contact cable.

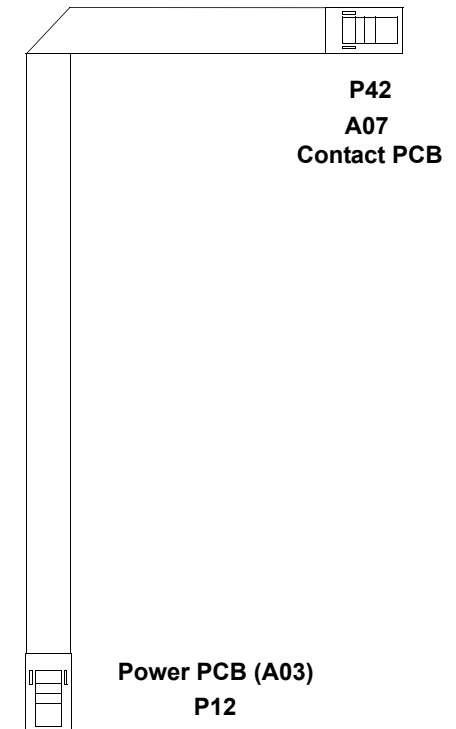

**Figure 10.107—Power/contact PCB cable connections**

### Installing the Power/Contact PCB Cable (W05)

- ◆ To install the power/contact PCB cable:
  1. Connect the power/contact PCB cable ([3207261-001](#)) to J42 of contact PCB (A07).
  2. Install the NIBP/CO2 assembly as described in [Installing the NIBP \(A21\)/CO2 \(A23\) Modules \(p. 412\)](#).
  3. Install the OEM PCB as described in [Installing the OEM PCB \(A06\) \(p. 385\)](#).
  4. Install the transfer relay assembly as described in [Installing the Transfer Relay Assembly \(A13\) \(p. 390\)](#).
  5. Connect the power/contact PCB cable to the power PCB (A03) at J12 (may be labeled P12).
  6. Install the system/therapy PCB assembly as described in [Installing the System \(A01\)/Therapy \(A04\) PCB Assembly \(p. 359\)](#).
  7. Reassemble the case as described in [Reassembling the Case \(p. 304\)](#).

### ECG Connector Cable (W07) Replacement

ECG connector cable replacement consists of the following procedures:

- [Removing the ECG Connector Cable \(W07\) \(p. 449\)](#)
- [Installing the ECG Connector Cable \(W07\) \(p. 450\)](#)

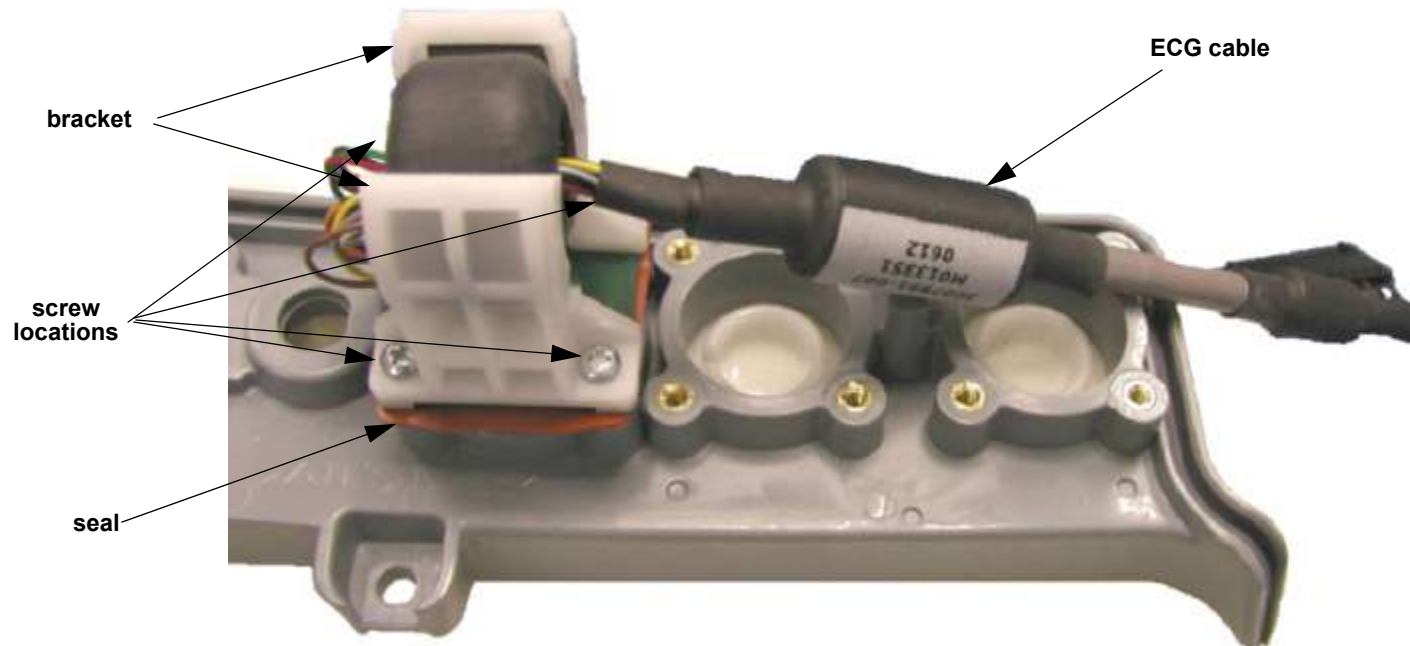

Figure 10.108—ECG cable part and screw locations

### Removing the ECG Connector Cable (W07)

Refer to [Figure 10.108](#) on p. 448.

- ◆ To remove the ECG connector cable ([3007991-007](#)) from the rear case (refer to [Inside Rear Case Diagrams \(p. 348\)](#)):
  1. Disassemble the case as described in [Disassembling the Case \(p. 301\)](#).
  2. Disconnect the ECG cable from the J6 connector on the system PCB (A01).
  3. Remove the parameter bezel as described in [Removing the Parameter Bezel \(p. 431\)](#).
  4. Remove the four screws ([202253-763](#)) securing the support bracket ([3205680-001](#)) that holds the ECG connector cable ([3007991-007](#)). Remove the connector, seal and screws. Discard the seal and screws.

### Installing the ECG Connector Cable (W07)

Refer to [Figure 10.108 on p. 448](#).

- ◆ To install the ECG connector cable into the rear case (refer to [Inside Rear Case Diagrams \(p. 348\)](#)):

**NOTE:** When installing a new ECG cable, use the [ECG Connector Repair Kit \(MIN 3305431-010\) \(p. 620\)](#).

1. Mount the ECG receptacle contact cable ([3007991-007](#)) on the ECG seal ([805915-01](#)). Orient the ECG receptacle groove to the notch in the seal.
2. Capture the cable ferrite between the two cable support brackets ([3205680-001](#)) and line up the ECG receptacle.
3. Secure the ECG connector cable and support brackets to the parameter bezel with the four new screws ([202253-763](#)); torque to 6.8 in-lb.

#### CAUTION

**POSSIBLE MOISTURE LEAKAGE** When installing the ECG connector cable, use a new seal ([805915-01](#)) to help prevent ingress of fluids.

4. Install the parameter bezel as described in [Installing the Parameter Bezel \(p. 433\)](#).
5. Connect the ECG cable ([3007991-007](#)) to the J6 connector on the system PCB (A01).
6. Reassemble the case as described in [Reassembling the Case \(p. 304\)](#).

### System Connector Cable (W08) and Auxiliary Connector Cable (W09) Replacement

The system connector and auxiliary power cable replacement consists of the following procedures:

- [Removing the System Connector Cable \(W08\) or Auxiliary Power Cable \(W09\) \(p. 452\)](#)
- [Installing the System Connector Cable \(W08\) or Auxiliary Power Cable \(W09\) \(p. 453\)](#)

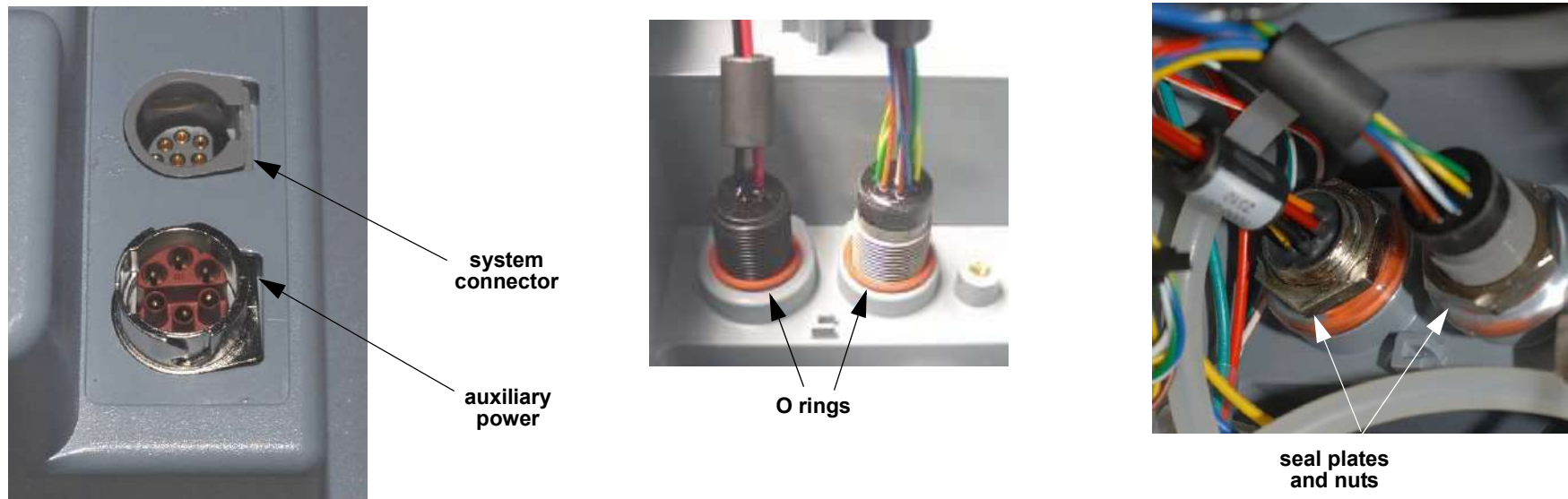

Figure 10.109—System connector cable and auxiliary power cable location and parts

### Removing the System Connector Cable (W08) or Auxiliary Power Cable (W09)

Refer to [Figure 10.109](#) on p. 451.

- ◆ To remove the system connector cable ([3009652-01](#)) or auxiliary power cable (V2 part [3303848-002](#)), from the rear case:
  1. Disassemble the case as described in [Disassembling the Case](#) (p. 301).
  2. Remove the parameter bezel as described in [Removing the Parameter Bezel](#) (p. 431).
  3. Remove the power PCB as described in [Removing the Power PCB \(A03\)](#) (p. 374).
  4. If required, remove the system connector cable nut ([806091-00](#)), connector seal ([805487-00](#)), and O-ring seal ([200060-011](#)). Remove the System connector cable.
  5. If required, remove the auxiliary power cable nut ([806091-00](#)), connector seal ([805487-00](#)), and O-ring seal ([200060-011](#)). Remove the connector.



### Installing the System Connector Cable (W08) or Auxiliary Power Cable (W09)

Refer to [Figure 10.109](#) on p. 451.

- ◆ To install the system connector cable or auxiliary power cable into the rear case:

**NOTE:** When installing a new system connector cable ([3009652-01](#)) or auxiliary power cable (V2 part [3303848-002](#)), use the [Internal Hardware Repair Kit \(MIN 3305431-015\)](#) (p. 624) and [External Hardware Repair Kit \(MIN 3305431-016\)](#) (p. 624).

#### CAUTION

**POSSIBLE MOISTURE LEAKAGE** When installing the system connector cable, use a new O-ring seal to help prevent ingress of fluids.

1. If removed, install the system connector cable in hole above the auxiliary power cable connector.
2. Thread the new O-ring ([200060-011](#)) over wire connector of the system cable.
3. Thread seal plate ([805487-00](#)) (flat side down) and nut ([806091-00](#)) over wire connector of the system cable (torque to 10 in-lb using a 3/4" modified deep socket).
4. If removed, install auxiliary power cable in the lower hole provided in rear case.
5. Thread the new O-ring ([200060-011](#)) over wire connector of the auxiliary power cable.
6. Thread seal plate ([805487-00](#)) (flat side down) and nut ([806091-00](#)) over wire connector of the auxiliary power cable (torque to 10 in-lb using a 3/4" modified deep socket).
7. Install the power PCB as described in [Installing the Power PCB \(A03\)](#) (p. 377).
8. Install the parameter bezel as described in [Installing the Parameter Bezel](#) (p. 433).
9. Install the system/therapy PCB assembly as described in [Installing the System \(A01\)/Therapy \(A04\) PCB Assembly](#) (p. 359).
10. Reassemble the case as described in [Reassembling the Case](#) (p. 304).

### Battery Pins / Power PCB Cable (W10) Replacement

- Removing the Battery Pins/Power PCB Cable (W10) (p. 455)
- Installing the Battery Pins/Power PCB Cable (W10) (p. 456)

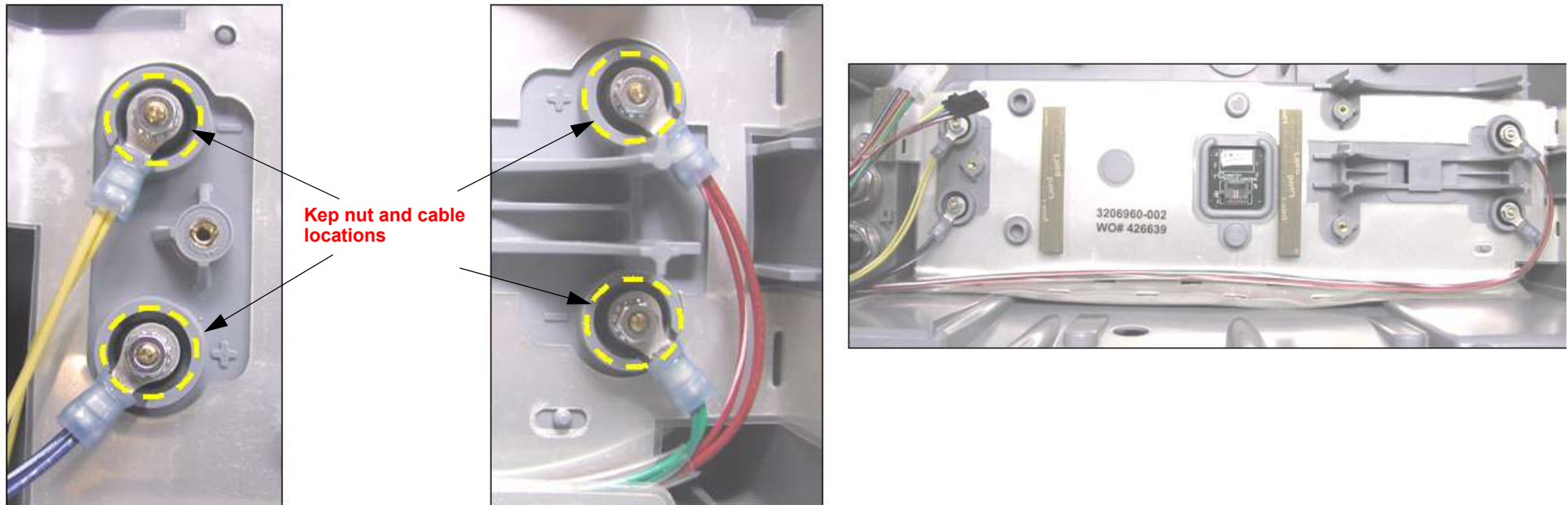

Figure 10.110—Power PCB cable Kep nut and cable locations

### Removing the Battery Pins/Power PCB Cable (W10)

Refer to [Figure 10.110 on p. 454](#) and [Figure 10.99 on p. 425](#).

- ◆ To remove the Battery Pins/Power PCB Cable (W10) from the rear case (see [Figure 11.17 on p. 523](#)):
  1. Disassemble the case as described in [Disassembling the Case \(p. 301\)](#).
  2. Remove the system/therapy board as described in [Removing the System \(A01\)/Therapy \(A04\) PCB Assembly \(p. 353\)](#).
  3. Remove the transfer relay assembly as described in [Removing the Transfer Relay Assembly \(A13\) \(p. 389\)](#). (It is not necessary to remove the spade terminals as described in the procedure.)
  4. Remove the biphasic module and inductive resistor as described in [Removing the Biphasic Module \(A22\)/Inductive Resistor \(A14\) \(p. 419\)](#). (It is not necessary to remove the spade terminals as described in the procedure.)
  5. Observing orientation, cut the large tie wrap securing the A15 energy storage capacitor and interconnect bracket to the rear case. Remove the transfer relay, biphasic module assembly, energy storage capacitor and interconnect bracket **without removing small cable ties and spade terminal connections**.
  6. Remove the OEM PCB as described in [Removing the OEM PCB \(A06\) \(p. 382\)](#).
  7. Remove the power PCB as described in [Removing the Power PCB \(A03\) \(p. 374\)](#).
  8. Remove the NIBP/CO2 assembly as described in [Removing the NIBP \(A21\)/CO2 \(A23\) Modules \(p. 408\)](#). (Removing the bracket cover in this procedure is not required.)
  9. Remove the four Kep nuts ([201508-000](#)) to disconnect terminals P43 and P44 at battery well 1, and P45 and P46 at battery well 2 (see [Figure 10.99 on p. 425](#)). Note the wire colors and orientation for reinstalling the wires to the same studs. Remove the cable.
  10. If replacing the EMI shield, lift the EMI shield out of the rear case and discard. Clean the rear case of residual adhesive.

### Installing the Battery Pins/Power PCB Cable (W10)

- ◆ To install the W10 cable: *12 steps, (Page 1 of 2)*

If required, replace EMI shield as described in [EMI Shield Replacement \(p. 425\)](#).

1. Install the battery pins/power PCB (W10) cable (V1- 3009726-08) or (V2-3303863-000).
2. Connect terminals P43 and P44 at Battery Well 1, and P45 and P46 at Battery Well 2 and replace the four Kep nuts (201508-000) (torque to 4.0 in-lb using 1/4" socket and drive adapter). See [Figure 10.110 on p. 454](#).
3. Install the power PCB as described in [Installing the Power PCB \(A03\) \(p. 377\)](#).
4. If present, install the SpO2 PCB as described in [Installing the SpO2 PCB \(A16\) \(p. 400\)](#).
5. Connect the battery pins/power PCB cable (W10) connector locking tabs to the power PCB at J11. V1 device will also install W10 at J13.
6. Install the NIBP/CO2 Module as described in [Installing the NIBP \(A21\)/CO2 \(A23\) Modules \(p. 412\)](#).
7. Install the OEM PCB as described in [Installing the OEM PCB \(A06\) \(p. 385\)](#).
8. Install the energy storage capacitor as described in [Installing the Energy Storage Capacitor \(A15\) \(p. 393\)](#).
9. Install the biphasic module and inductive resistor as described in [Installing the Biphasic Module \(A22\)/Inductive Resistor \(A14\) \(p. 422\)](#).
10. Install the transfer relay assembly as described in [Installing the Transfer Relay Assembly \(A13\) \(p. 390\)](#).

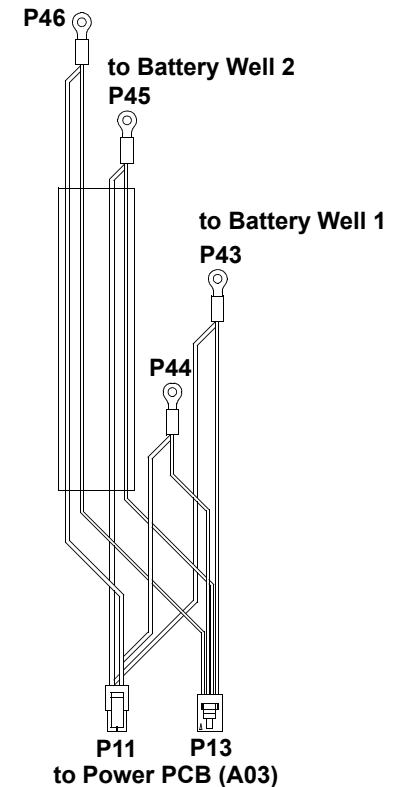

**Figure 10.111—(V1) Power PCB cable connections. V2 cable, only P11 is used.**

- ◆ To install the W10 cable: *(Continued) 12 steps, (Page 2 of 2)*
  11. Install the system/memory/therapy PCB assembly as described in [Installing the System \(A01\)/Therapy \(A04\) PCB Assembly \(p. 359\)](#).
  12. Reassemble the case as described in [Reassembling the Case \(p. 304\)](#).

### USB Flex Module (W14) Replacement

USB flex module replacement consists of the following procedures:

- [Removing the W14 - USB Flex Module \(p. 459\)](#)
- [Installing the W14 - USB Flex Module \(p. 459\)](#)

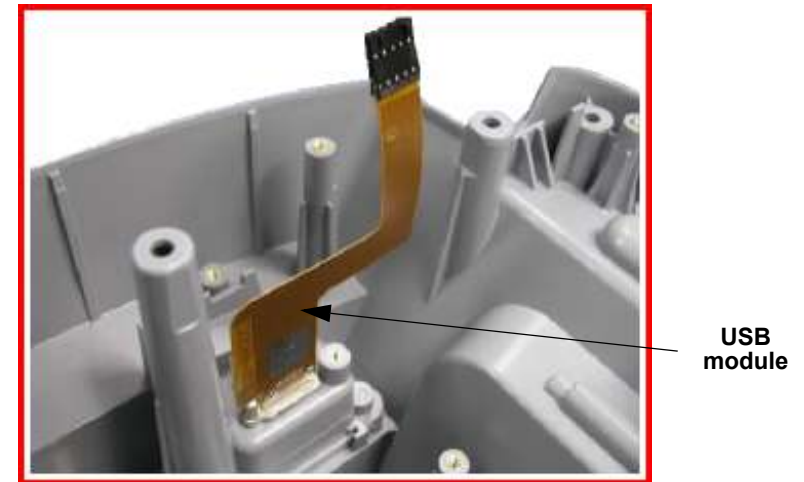

Figure 10.112—USB flex module

### Removing the W14 - USB Flex Module

- ◆ To remove the USB flex module (W14) ([3206966-001](#)):
  1. Disassemble the case as described in [Disassembling the Case \(p. 301\)](#).
  2. Remove the system/therapy board as described in [Removing the System \(A01\)/Therapy \(A04\) PCB Assembly \(p. 353\)](#).
  3. Remove the parameter bezel as described in [Removing the Parameter Bezel \(p. 431\)](#).
  4. From inside the rear case, remove the screw ([202253-761](#)) holding the spring clip ([3012693-00](#)). Remove the spring clip. Discard the screw.
  5. From the outside rear of the case, loosen the two retained screws and remove the USB access door ([3206959-001](#)).
  6. Remove the two USB connector mounting screws ([202253-761](#)). Discard the screws.
  7. Remove the USB flex assembly.

### Installing the W14 - USB Flex Module

To install the USB flex module (W14) ([3206966-001](#)):

1. From inside of the rear case, place the USB flex module into slot in the rear case.
2. Install the spring clip ([3012693-00](#)) using one new screw ([202253-761](#)); torque to 6.8 in-lb.
3. From the outside of the rear case, install two screws ([202253-761](#)) into the USB flex module; torque to 6.8 in-lb.
4. Install the USB access door ([3206959-001](#)) by tightening the two retained screws; torque to 6.8 in-lb.
5. Install the parameter bezel as described in [Installing the Parameter Bezel \(p. 433\)](#).
6. Install the system/therapy PCB assembly as described in [Installing the System \(A01\)/Therapy \(A04\) PCB Assembly \(p. 359\)](#).
7. Reassemble the case as described in [Reassembling the Case \(p. 304\)](#).

### Biphasic Cable (W20) Replacement

Biphasic cable replacement consists of the following procedures:

- [Removing the Biphasic Cable \(W20\) \(p. 461\)](#)
- [Installing the Biphasic Cable \(W20\) \(p. 461\)](#)

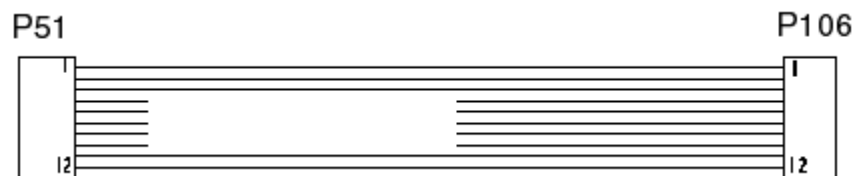

Current version of Biphasic  
cable [3011792-005](#)

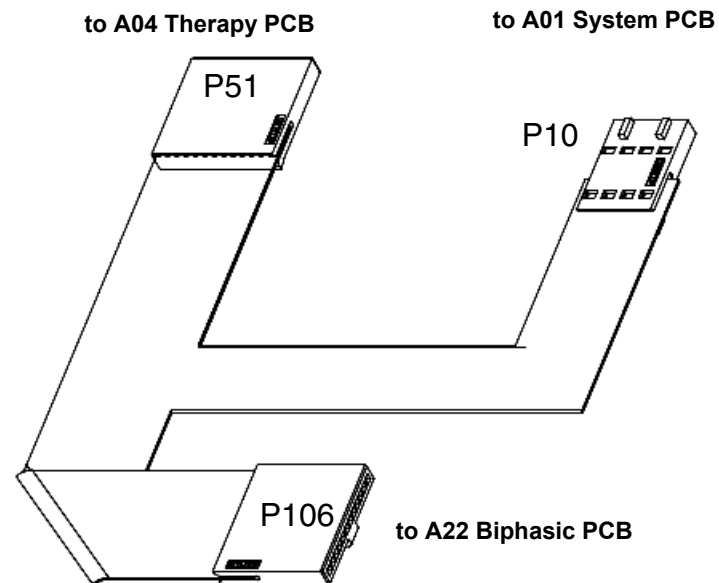

Previous version 3206999 cable is no longer orderably

FLEX CABLE FOLDED VIEW

Figure 10.113— Biphasic cables



### Removing the Biphasic Cable (W20)

- ◆ To remove the biphasic cable (W20) from the rear case:
  1. Disassemble the case as described in [Disassembling the Case \(p. 301\)](#).
  2. Press the connector locking tab and eject the W20 cable from the A22 biphasic PCB at J106.
  3. For biphasic cable (3206999) only, press the connector locking tab and eject the W20 cable from the A01 system PCB at J10.
  4. Press the connector locking tab and eject the W20 cable from the A04 therapy PCB at J51.

### Installing the Biphasic Cable (W20)

- ◆ To install the biphasic cable (W20) into the rear case:
  1. Connect the W20 cable to the A04 Therapy PCB at J51.
  2. For biphasic cable (6206999) only, connect the W20 cable to the A01 System PCB at J10.
  3. Connect the W20 cable to the A22 biphasic PCB at J106.
  4. Reassemble the case as described in [Reassembling the Case \(p. 304\)](#).

### OEM PCB/SpO2 (W21) Module Cable Replacement

OEM PCB/SpO2 Module cable replacement consists of the following procedures:

- [Removing the OEM PCB/SpO2 Module Cable \(W21\) \(p. 463\)](#)
- [Installing the OEM PCB/SpO2 Module Cable \(W21\) \(p. 463\)](#)

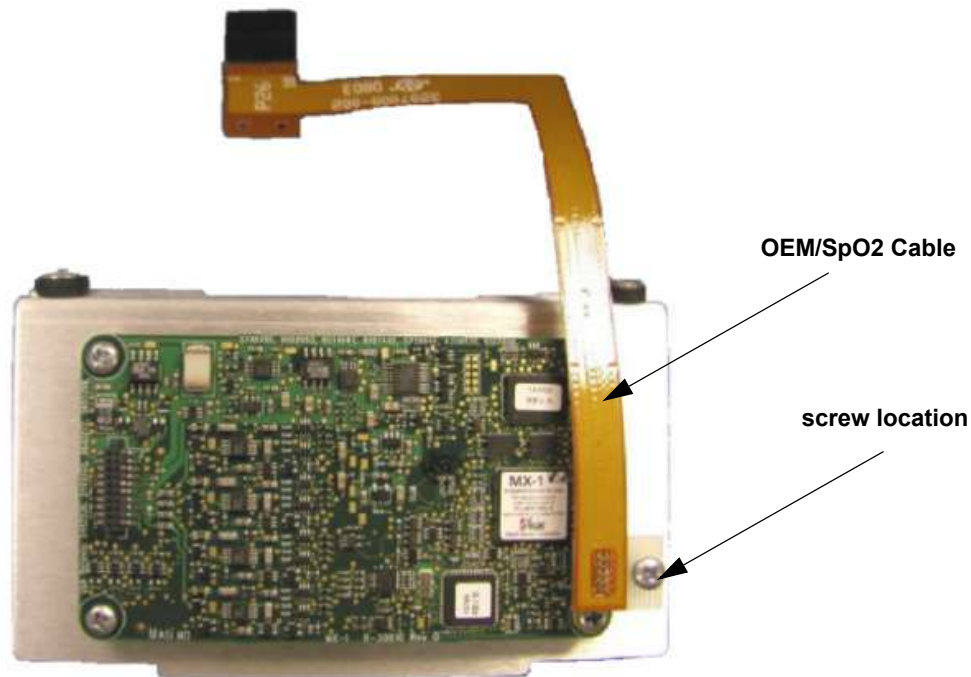

Figure 10.114—OEM/SpO2 cable screw location

### Removing the OEM PCB/SpO2 Module Cable (W21)

- ◆ To remove the OEM PCB/SpO2 cable ([3207000-004](#)) from the rear case:
  1. Disassemble the case as described in [Disassembling the Case \(p. 301\)](#).
  2. Remove the system/therapy PCB assembly as described in [System \(A01\)/Therapy \(A04\) PCB Assembly Replacement \(p. 352\)](#).
  3. Remove the SpO2 module (A26) as described in [Removing the SpO2 PCB \(A16\) \(p. 395\)](#). Do not remove SpO2 connector flex cable (W22) as described in step 8 of that procedure.
  4. Lift SpO2 assembly from rear enough to gain access to screw. Remove and discard the screw ([202253-760](#)) holding the W21 cable to the J3 connector.
  5. Disconnect the OEM PCB/SpO2 cable from the SpO2 module (A16) at J3. The SpO2 module will still be connected to the system by the SpO2 connector flex cable.

### Installing the OEM PCB/SpO2 Module Cable (W21)

- ◆ To install the OEM PCB/SpO2 cable ([3207000-004](#)):
  1. Connect the OEM PCB/SpO2 cable to the SpO2 Module (A16) at J3.
  2. Install one new screw ([202253-760](#)) on the SpO2 module holding the W21 cable to the J3 connector; torque to 4.0 in-lb.
  3. Install the SpO2 module (A16) as described in [Installing the SpO2 PCB \(A16\) \(p. 400\)](#).
  4. Install the system/therapy PCB assembly as described in [System \(A01\)/Therapy \(A04\) PCB Assembly Replacement \(p. 352\)](#).
  5. Reassemble the case as described in [Reassembling the Case \(p. 304\)](#).

### SpO2 Connector Cable (W22) Replacement

SpO2 connector cable replacement consists of the following procedures:

- [Removing the SpO2 Connector Cable \(W22\) \(p. 465\)](#)
- [Installing the SpO2 Connector Cable \(W22\) \(p. 465\)](#)



SpO2 connector  
orientation



Figure 10.115—SpO2 connector cable

### Removing the SpO2 Connector Cable (W22)

- ◆ To remove the SpO2 connector cable ([3206995-004](#)) from the rear case (refer to [Inside Rear Case Diagrams \(p. 348\)](#) and [Figure 11.21 on p. 533](#)):
  1. Disassemble the case as described in [Disassembling the Case \(p. 301\)](#).
  2. Remove the system/therapy PCB assembly as described in [System \(A01\)/Therapy \(A04\) PCB Assembly Replacement \(p. 352\)](#).
  3. Remove the parameter bezel as described in [Removing the Parameter Bezel \(p. 431\)](#).
  4. Remove the four screws ([3205311-001](#)) (using a Torx T-10 bit) securing the ferrite housing ([3207009-000](#)) and SpO2 connector cable. Discard the screws.
  5. Remove the connector from the parameter bezel.

### Installing the SpO2 Connector Cable (W22)

- ◆ To install the SpO2 connector cable ([3206995-004](#)) into the rear case (refer to [Inside Rear Case Diagrams \(p. 348\)](#)):

**NOTE:** When replacing the SpO2 cable use [MASIMO SpO2 Panel Mount Cable Repair Kit \(MIN 3305431-026\) \(p. 631\)](#).

1. Fold SpO2 connector cable (W22) over the top of the ferrite bead and then position the ferrite bead behind the connector.
2. Install the ferrite housing ([3207009-000](#)) over the flex cable and ferrite bead.
3. Insert the SpO2 connector cable into the parameter bezel and secure with the four new screws ([3205311-001](#)); torque to 2 in-lb using a Torx T-10 bit (see [Figure 10.115 on p. 464](#) for connector orientation).
4. Install the parameter bezel as described in [Installing the Parameter Bezel \(p. 433\)](#).
5. Install the system/therapy PCB assembly as described in [Installing the System \(A01\)/Therapy \(A04\) PCB Assembly \(p. 359\)](#).
6. Reassemble the case as described in [Reassembling the Case \(p. 304\)](#).

### OEM PCB/CO2 Module Cable (W26) Replacement

OEM PCB/CO2 Module cable replacement consists of the following procedures:

- [Removing the OEM PCB/CO2 Module Cable \(W26\) \(p. 467\)](#)
- [Installing the OEM PCB/CO2 Module Cable \(W26\) \(p. 467\)](#)

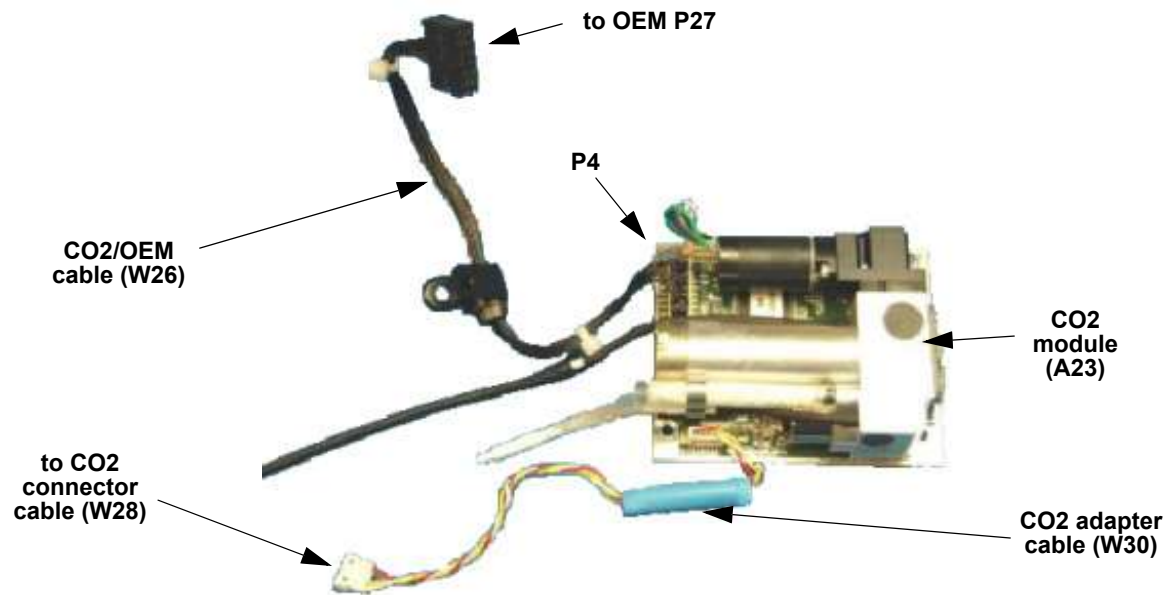

Figure 10.116—CO2 module cable

### Removing the OEM PCB/CO2 Module Cable (W26)

Refer to [Figure 10.116 on p. 466](#).

- ◆ To remove the OEM PCB/CO2 module cable ([3206998-002](#)) from the rear case:
  1. Disassemble the case as described in [Disassembling the Case \(p. 301\)](#).
  2. Remove the system/therapy PCB assembly as described in [System \(A01\)/Therapy \(A04\) PCB Assembly Replacement \(p. 352\)](#).
  3. Remove the OEM PCB (A06) as described in [Removing the OEM PCB \(A06\) \(p. 382\)](#). (This step disconnects the W26 cable from the OEM PCB.)
  4. Remove the NIBP/CO2 module as described in [Removing the NIBP \(A21\)/CO2 \(A23\) Modules \(p. 408\)](#).
  5. Disconnect the OEM PCB/CO2 module cable from the CO2 PCB (A23) at J4.

### Installing the OEM PCB/CO2 Module Cable (W26)

Refer to [Figure 10.116 on p. 466](#).

- ◆ To install the OEM PCB/CO2 module cable ([3206998-002](#)) into the rear case:
  1. Connect the OEM PCB/CO2 module cable to the A23 CO2 PCB at J4.
  2. Install the NIBP/CO2 Module as described in [Installing the NIBP \(A21\)/CO2 \(A23\) Modules](#).
  3. Install the OEM PCB (A06) as described in [Installing the OEM PCB \(A06\)](#).
  4. Install the system/therapy PCB assembly as described in [Installing the System \(A01\)/Therapy \(A04\) PCB Assembly](#).
  5. Reassemble the case as described in [Reassembling the Case \(p. 304\)](#).

### OEM PCB/NIBP Module Cable (W27) Replacement

OEM PCB/NIBP Module cable replacement consists of the following procedures:

- [Removing the OEM PCB/NIBP Module Cable \(W27\) \(p. 469\)](#)
- [Installing the OEM PCB/NIBP Module Cable \(W27\) \(p. 469\)](#)

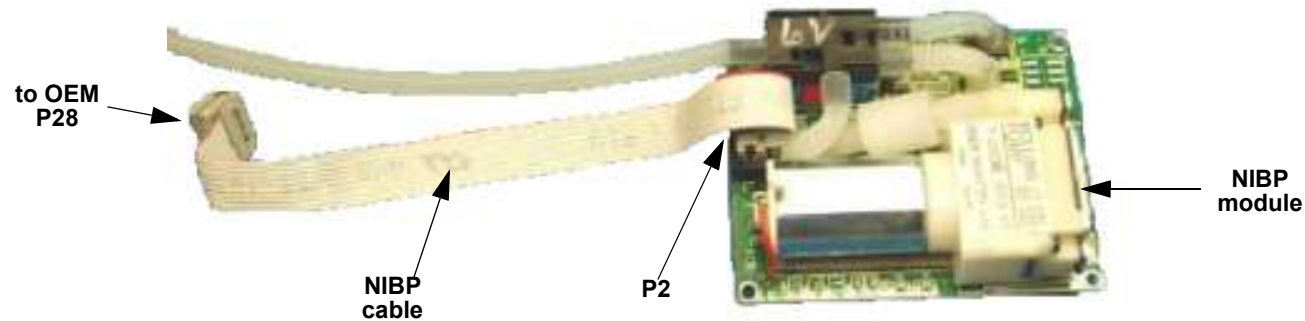

Figure 10.117—NIBP module cable



### Removing the OEM PCB/NIBP Module Cable (W27)

Refer to [Figure 10.117 on p. 468](#).

- ◆ To remove the OEM PCB/NIBP module cable ([3012181-02](#)) from the rear case:
  1. Disassemble the case as described in [Disassembling the Case \(p. 301\)](#).
  2. Remove the system/therapy PCB assembly as described in [System \(A01\)/Therapy \(A04\) PCB Assembly Replacement \(p. 352\)](#).
  3. Remove the OEM PCB (A06) as described in [Removing the OEM PCB \(A06\) \(p. 382\)](#). (This step disconnects the W27 cable from the OEM PCB.)
  4. Remove the NIBP/CO2 module as described in [Removing the NIBP \(A21\)/CO2 \(A23\) Modules \(p. 408\)](#).
  5. Disconnect the OEM PCB/NIBP module cable (W27) from the A21 NIBP PCB at J2.

### Installing the OEM PCB/NIBP Module Cable (W27)

Refer to [Figure 10.117 on p. 468](#).

- ◆ To install the OEM PCB/NIBP module cable ([3012181-02](#)):
  1. Connect the OEM PCB/NIBP module cable to the A21 NIBP PCB at J2.
  2. Install the NIBP/CO2 module as described in [Installing the NIBP \(A21\)/CO2 \(A23\) Modules \(p. 412\)](#).
  3. Install the OEM PCB (A06) as described in [Installing the OEM PCB \(A06\) \(p. 385\)](#).
  4. Install the system/therapy PCB assembly as described in [Installing the System \(A01\)/Therapy \(A04\) PCB Assembly \(p. 359\)](#).
  5. Reassemble the case as described in [Reassembling the Case \(p. 304\)](#).

### CO2 Inlet Connector Cable (W28) Replacement

CO2 inlet connector cable replacement consists of the following procedures:

- [Removing the CO2 Inlet Connector Cable \(W28\) \(p. 471\)](#)
- [Installing the CO2 Inlet Connector Cable \(W28\) \(p. 472\)](#)

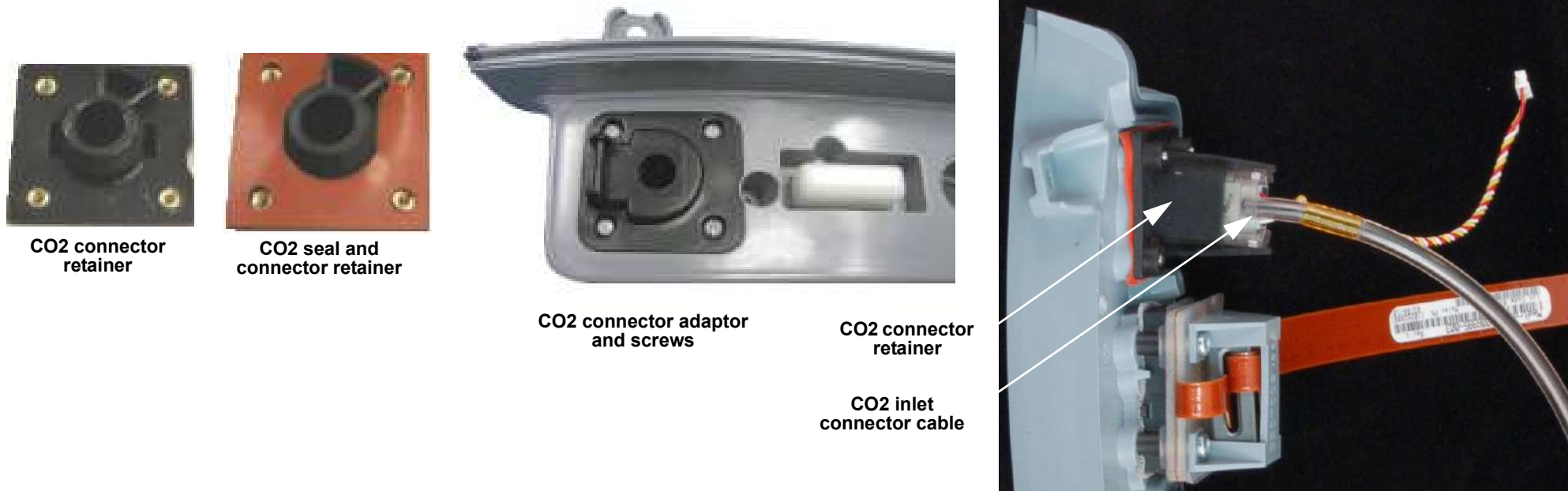

Figure 10.118—CO2 connector parts

### Removing the CO2 Inlet Connector Cable (W28)

- ◆ To remove the CO2 inlet connector cable (3012140-008) from the parameter bezel (rear case—refer to [Inside Rear Case Diagrams \(p. 348\)](#) and [Figure 11.21 on p. 533](#)):
  1. Disassemble the case as described in [Disassembling the Case \(p. 301\)](#).
  2. Remove the system/therapy PCB assembly as described in [Removing the System \(A01\)/Therapy \(A04\) PCB Assembly \(p. 353\)](#).
  3. Remove the parameter bezel as described in [Removing the Parameter Bezel \(p. 431\)](#).
  4. Remove the four screws (202253-732) securing the CO2 connector adapter (3012119-02) to the parameter bezel.
  5. Remove the CO2 connector adapter and, from the underside of the bezel, remove the CO2 connector retainer (3012121-002) and seal (3007997-01). Discard the seal and screws.
  6. Disengage the CO2 inlet connector cable from the CO2 connector retainer by spreading the arms of the retainer and sliding out the CO2 inlet connector body (see [Figure 10.118 on p. 470](#)). Discard the connector retainer clip.

### Installing the CO2 Inlet Connector Cable (W28)

◆ To install the CO2 inlet connector cable:

**NOTE:** When replacing the CO2 inlet connector cable assembly, use [CO2 Connector Repair Kit \(MIN 3305431-014\)](#) (p. 623).

1. Set the CO2 connector adapter ([3012119-02](#)) in place on the face of the new bezel.
2. Place the new CO2 connector retainer ([3012121-002](#)) and new seal ([3007997-01](#)) in place on the underside of the bezel and tighten together with four new screws ([202253-732](#)); torque to 2.0 in-lb using a PO bit.
3. Slide the CO2 inlet connector cable (W28) ([3012140-008](#)) into the new CO2 connector retainer.

#### CAUTION

**POSSIBLE MOISTURE LEAKAGE** When installing the W28 cable, apply 2 in-lb of torque when installing the screw retaining the W28 cable to help prevent ingress of fluids.

4. Install the parameter bezel as described in [Installing the Parameter Bezel](#) (p. 433).
5. Install the system/therapy PCB assembly as described in [Installing the System \(A01\)/Therapy \(A04\) PCB Assembly](#) (p. 359).
6. Reassemble the case as described in [Reassembling the Case](#) (p. 304).

### CO2 Adapter Cable (W30) Replacement

CO2 Adapter cable replacement consists of the following procedures:

- [Removing the CO2 Adapter Cable \(W30\) \(p. 474\)](#)
- [Installing the CO2 Adapter Cable \(W30\) \(p. 474\)](#)

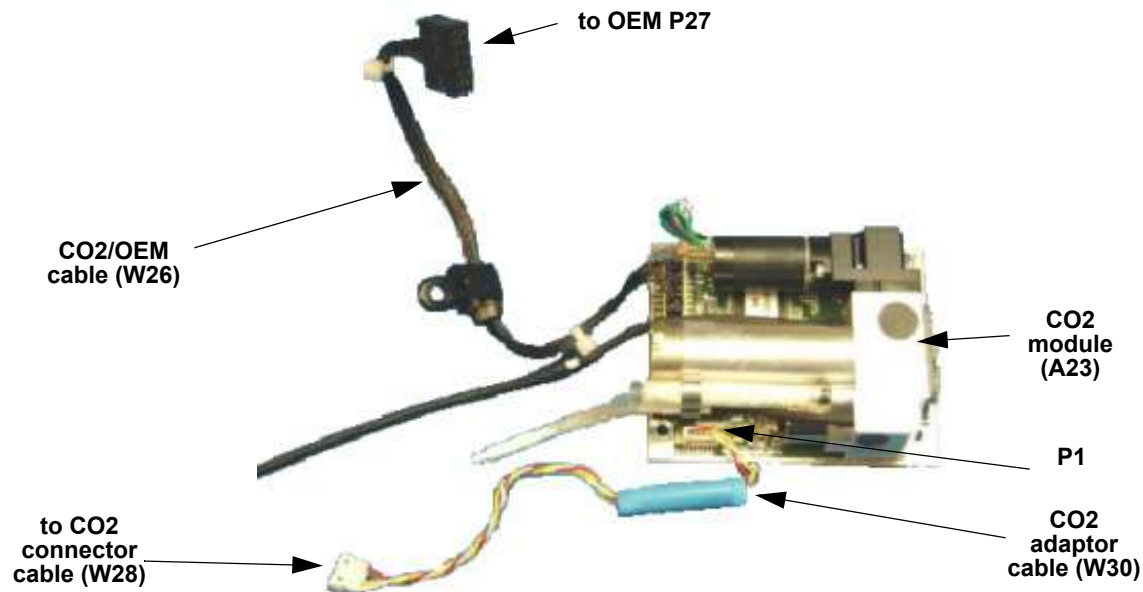

Figure 10.119—CO2 module and cables

### Removing the CO2 Adapter Cable (W30)

Refer to [Figure 10.119 on p. 473](#).

- ◆ To remove the CO2 adapter cable ([3012397-01](#)) from the rear case:
  1. Disassemble the case as described in [Disassembling the Case \(p. 301\)](#).
  2. Remove the system/therapy PCB assembly as described in [Removing the System \(A01\)/Therapy \(A04\) PCB Assembly \(p. 353\)](#).
  3. Remove the OEM PCB (A06) as described in [Removing the OEM PCB \(A06\) \(p. 382\)](#).
  4. Remove the NIBP/CO2 module as described in [Removing the NIBP \(A21\)/CO2 \(A23\) Modules \(p. 408\)](#).
  5. Disconnect the CO2 adapter cable from the CO2 PCB (A23) at J1.

### Installing the CO2 Adapter Cable (W30)

Refer to [Figure 10.119 on p. 473](#).

- ◆ To install the CO2 adapter cable ([3012397-01](#)) from the rear case:
  1. Connect the CO2 adapter cable to the A23 CO2 PCB at J1.
  2. Install the NIBP/CO2 Module as described in [Installing the NIBP \(A21\)/CO2 \(A23\) Modules \(p. 412\)](#).
  3. Install the OEM PCB (A06) as described in [Installing the OEM PCB \(A06\) \(p. 385\)](#).
  4. Install the system/therapy PCB assembly as described in [Installing the System \(A01\)/Therapy \(A04\) PCB Assembly \(p. 359\)](#).
  5. Reassemble the case as described in [Reassembling the Case \(p. 304\)](#).

### Invasive Pressure Connector Assembly (W33) Replacement

Invasive pressure connector assembly replacement consists of the following procedures:

- [Removing the Invasive Pressure Connector Assembly \(W33\) \(p. 476\)](#)
- [Installing the Invasive Pressure Connector Assembly \(W33\) \(p. 476\)](#)

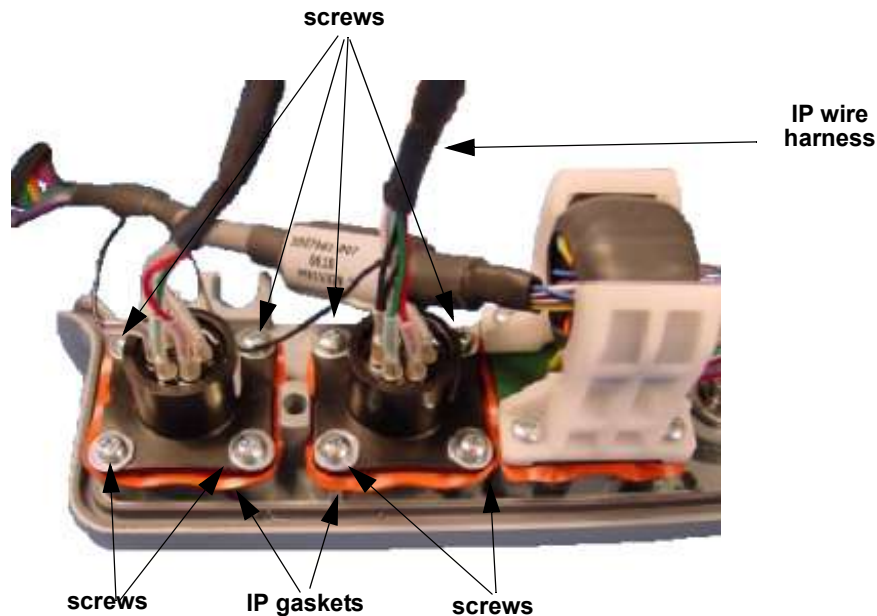

Figure 10.120—Invasive pressure parts and screw locations

### Removing the Invasive Pressure Connector Assembly (W33)

- ◆ To remove the invasive pressure connector assembly from the rear case (refer to [Inside Rear Case Diagrams \(p. 348\)](#)):
  1. Disassemble the case as described in [Disassembling the Case \(p. 301\)](#).
  2. Disconnect the invasive pressure cable ([3200466-01](#)) from the J7 connector on the system PCB (A01).
  3. Remove the parameter bezel as described in [Removing the Parameter Bezel \(p. 431\)](#).
  4. Remove the eight screws and captured washers ([3207337-312](#)) that secure the IP connectors to the parameter bezel. Remove the IP connectors and gaskets.
  5. Remove the IP connectors and gaskets. Discard the screws and gaskets.

### Installing the Invasive Pressure Connector Assembly (W33)

- ◆ To install the Invasive Pressure Connector Assembly into the rear case (refer to [Inside Rear Case Diagrams \(p. 348\)](#)):
  - NOTE:** When installing a new invasive pressure connector, use the [Invasive Pressure Connector Repair Kit \(MIN 3305431-001\)](#) (p. 613).
  1. Secure the IP connectors and new gaskets ([3007998-00](#)) to the parameter bezel with the eight new screws ([3207337-312](#)); torque to 6.8 in-lb. (See [Figure 11.12 on p. 514](#) for connector orientation.)

#### CAUTION

**POSSIBLE MOISTURE LEAKAGE** When installing the cable, use new gaskets to help prevent ingress of fluids.

2. Install the parameter bezel as described in [Installing the Parameter Bezel \(p. 433\)](#).
3. Connect the IP connector cable ([3200466-01](#)) to the system PCB (A01) at J7.
4. Reassemble the case as described in [Reassembling the Case \(p. 304\)](#).



### Temperature Cable Assembly (W35) Replacement

Temperature cable assembly replacement consists of the following procedures:

- [Removing the Temperature Cable Assembly \(W35\) \(p. 478\)](#)
- [Installing the Temperature Cable Assembly \(W35\) \(p. 478\)](#)

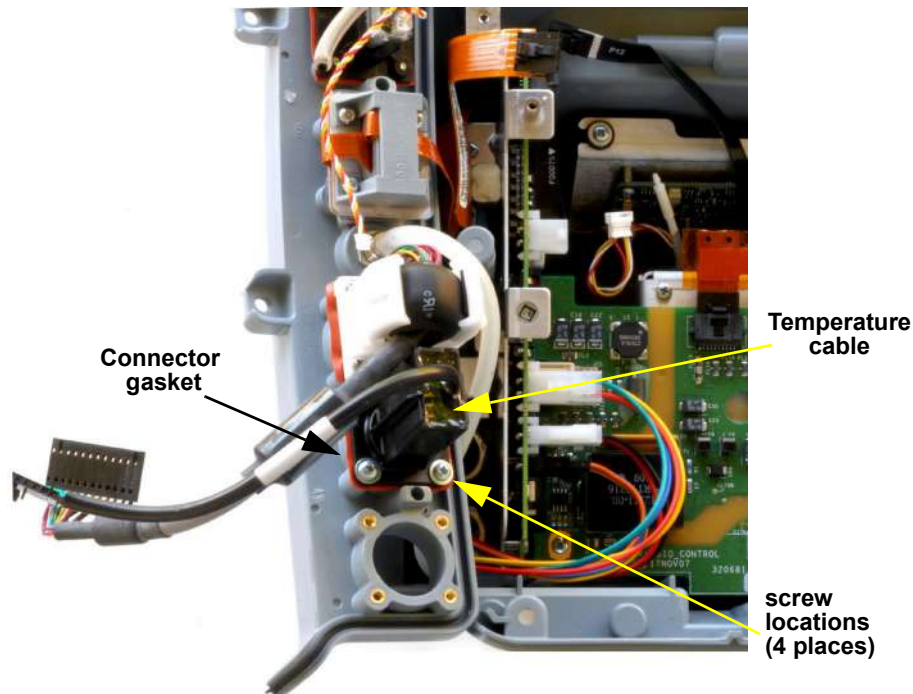

**Note:**  
Align ECG Ferrite as shown prior to installation into unit.



Figure 10.121—Temperature cable parts and screw locations

### Removing the Temperature Cable Assembly (W35)

- ◆ To remove the temperature cable assembly from the rear case (refer to [Inside Rear Case Diagrams \(p. 348\)](#)):
  1. Disassemble the case as described in [Disassembling the Case \(p. 301\)](#).
  2. Disconnect the temperature cable assembly ([3303936-001](#)) from the J7 connector on the system PCB (A01).
  3. Remove the parameter bezel as described in [Removing the Parameter Bezel \(p. 431\)](#).
  4. Remove the four screws and captured washers ([3207337-312](#)) that secure the temperature connector to the parameter bezel.
  5. Remove the temperature connector and gasket. Discard the screws and gasket.

### Installing the Temperature Cable Assembly (W35)

- ◆ To install the temperature cable assembly into the rear case (refer to [Inside Rear Case Diagrams \(p. 348\)](#)):

**NOTE:** When installing a new temperature cable assembly, use the [Temperature Cable Repair Kit \(MIN 3305431-027\) \(p. 632\)](#).

1. Place the temperature connector and new gasket ([3007998-00](#)) into the second connector mounting hole up from the bottom of the parameter bezel. Secure the temperature connector with four new screws ([3207337-312](#)); torque to 6.8 in-lb. (See [Figure 10.121 on p. 477](#) for connector orientation.)

#### CAUTION

**POSSIBLE MOISTURE LEAKAGE** When installing the cable, use new seal to help prevent ingress of fluids.

2. Install the parameter bezel as described in [Installing the Parameter Bezel \(p. 433\)](#).
3. Connect the temperature cable assembly ([3303936-001](#)) to the system PCB (A01) at J7.
4. Reassemble the case as described in [Reassembling the Case \(p. 304\)](#).

### Contact PCB (A07) Replacement

Contact PCB replacement consists of the following procedures:

- [Removing the Contact PCB \(A07\)](#) (p. 479)
- [Installing the Contact PCB \(A07\)](#) (p. 479)

#### Removing the Contact PCB (A07)

- ◆ To remove the contact PCB ([3207037-002](#)) (from outside the rear case) (see [Figure 11.14](#) on p. 520):
  1. Lay the device face down on a static-free, non-abrasive surface.
  2. Remove the two screws ([201407-069](#)) from the battery retainer ([3207881-000](#)) between the battery wells. Lift away the battery retainer. Discard the screws.
  3. Lift the Contact PCB away for rear case far enough to access and disconnect the power/contact PCB cable ([3207261-001](#)) (W05) at J42.

#### Installing the Contact PCB (A07)

- ◆ To install the contact PCB ([3207037-002](#)) on the outside of the rear case:
  1. Lay the device face down on a static-free, non-abrasive surface.
  2. Connect the contact PCB to the power/contact PCB cable (W05) at J42.
  3. Install the contact PCB by sliding the assembly straight down tracks in rear case.
  4. Install the two new screws ([201407-069](#)) into the battery retainer ([3207881-000](#)) between the battery wells; torque to 10.0 in-lb using P2 bit.

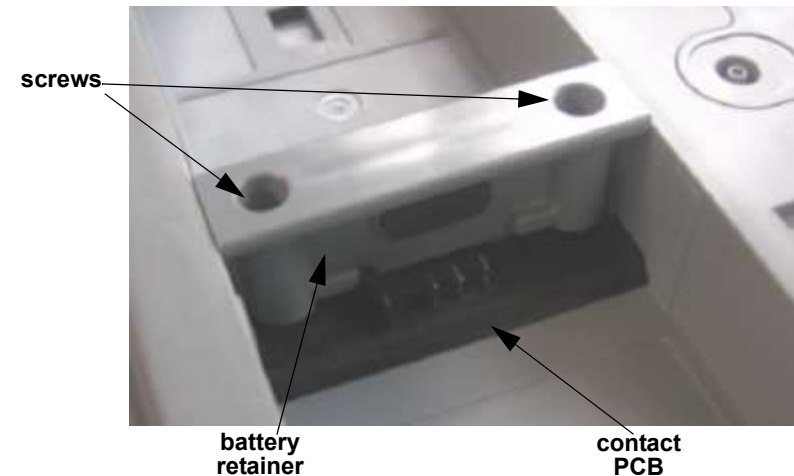

Figure 10.122—Contact PCB screw and part locations

### Printer Assembly (A12) Replacement

Printer assembly replacement consists of the following procedures:

- [Removing the Printer Assembly \(A12\) \(p. 480\)](#)
- [Installing the Printer Assembly \(A12\) \(p. 481\)](#)

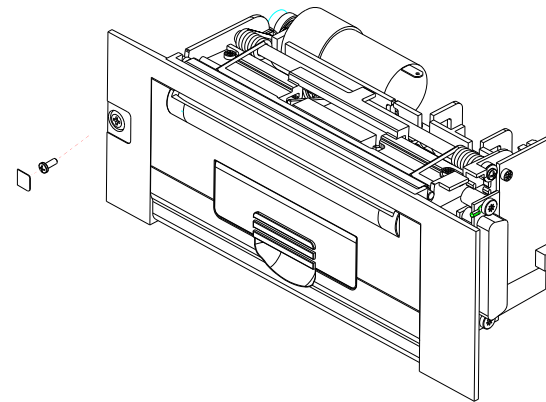

Figure 10.123—Printer assembly replacement

### Removing the Printer Assembly (A12)

- ◆ To remove the printer assembly from outside the front case:
  1. Lay the device face up on the battery wells.
  2. Remove the printer paper.
  3. Carefully peel away the label from the screw and loosen the screw.
  4. Open the printer door and loosen the two screws from inside the printer assembly.
  5. Grasp the door near the speaker side, and then gently pull up and push toward the speaker (to disengage the connector on the opposite side). Lift the printer out and set it aside.

### Installing the Printer Assembly (A12)

**NOTE:** The new printer comes with new screws installed to aid reassembly.

- ◆ To install the printer assembly into the front case.
  1. Lay the device face up on the battery wells.
  2. Insert the printer into the front case, and then gently push toward the therapy connector (to engage the printer connector)
  3. Tighten the two screws from inside the printer assembly; torque to 10 in.lb using a P2 bit.
  4. Tighten the third screw on the outside left side of printer; torque to 10 in.lb.
  5. Apply a new screw cover label. Apply the screw cover label (#6) from the label set ([3207318-XXX](#)) to the left front of printer.
  6. Install printer paper.



### Coin Battery Replacement

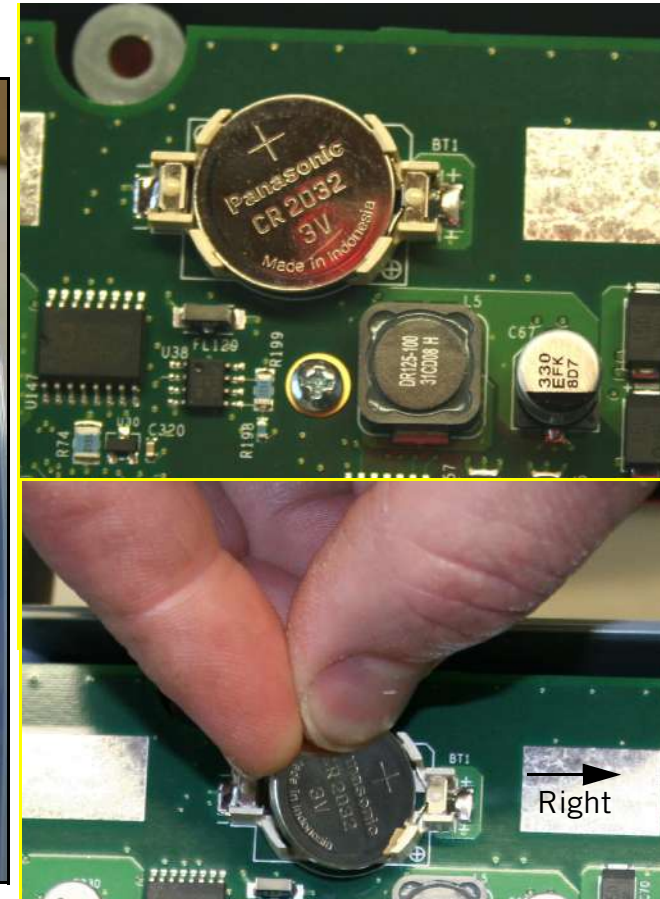

Figure 10.124—Coin battery location

- ◆ To replace the coin battery on the system PCB (A01) in the rear case (refer to [Inside Rear Case Diagrams \(p. 348\)](#)):
  1. Disassemble the case as described in [Disassembling the Case \(p. 301\)](#).
  2. With the new coin battery, (202305-000) (type CR2032), at hand, lift up from below the coin battery to remove. The coin battery will pop out of the holder. To install, slide in the new battery with (+) terminal up, place battery into right side of battery holder first. Press down to secure (see [Figure 10.124 on p. 482](#)).
  3. Reentry of time and date will be required after the coin battery replacement.
  4. The coin battery should be part of a five year replacement schedule (see [Scheduled Replacement Items \(p. 269\)](#)).

### Battery Pin Replacement



**Figure 10.125—Battery pins**

Inspect the battery connector pins as part of the routine physical inspection. Be sure to examine each leaf on the pins to ensure that they are not cracked or broken. Tighten any pins that are loose. Replace any pins that are bent, broken, corroded, worn, or damaged. Battery pins are replaced from outside the case.

- ◆ To replace a battery pin:
  1. Using a 4 mm modified socket, unscrew the pin and remove it.
  2. Torque the new battery pin ([802278-02](#)) to 4 in-lb.

**NOTE:** The battery grommets are not replaceable. Complete the Rear Case Replacement as described in [Rear Case Replacement \(p. 435\)](#) procedure to repair damaged battery grommets.



### Software and Device Upgrades

The LIFEPAK 15 monitor/defibrillator software and device upgrade procedures require specialized training and entail information proprietary to Physio-Control. These procedures should only be performed by authorized Physio-Control personnel.

For support, contact your local Physio-Control representative for assistance.

## Assembly Diagrams and Parts Lists

This section is a hierarchical reference used to identify components needed to repair the LIFEPAK 15 monitor/defibrillator.

- [Section Glossary \(p. 487\)](#)—Defines terms used in this section
- [Main Diagrams \(p. 488\)](#)—Shows the assembly diagram configurator and interconnect diagram with links to detailed assemblies and parts
- [Front Parts Diagrams and Parts List \(p. 497\)](#)—Includes multiple diagrams and table of parts for the front of the device
- [System/Therapy PCB Assembly Diagrams and Parts Lists \(p. 506\)](#)—Includes multiple diagrams and tables of parts for the assemblies of the device
- [Rear Diagrams and Parts List \(p. 519\)](#)—Includes multiple diagrams and table of parts for the rear of the device
- [OEM Optional Assemblies, Diagrams and Parts Lists \(p. 532\)](#)—Includes multiple diagrams and tables of parts for the assemblies of the device
- [Connection Diagrams for Assemblies, Control Boards, Cables, and Connectors \(p. 562\)](#)—Includes diagrams for parts illustrating connections
- [Repair Kits \(p. 610\)](#)—Contains all items needed to replace major components with separate MINs for each kit
- [Ordering Parts \(p. 639\)](#)—To obtain replacement parts for the device
- [Defibrillator Part Number and Serial Number \(p. 638\)](#)—Useful for decoding the SN on the device label, which displays the manufacturing code

**NOTE:** To view lists of MINs (part numbers) for language options (for example, labels and keypads), click the **Select other language** link (if available) in the Note column of a parts list.

**NOTE:** For additional parts lists, including items necessary to keep the device in clinical service, see [Devices, Options, Supplies, and Accessories \(p. 65\)](#).

### Section Glossary

The following are definitions of terms used in this section.

- **Common parts** are components used in every version of the defibrillator device, regardless of options and operating language. Common parts are divided into Front Case, Rear Case, and System/Therapy PCB Assembly.
- **Internal parts** are components internal to the case that are specific to your device.
- **External parts** are components external to the case that are specific to your device.
- The **Item** number on diagrams (used most often for cables and connectors) provides a reference number for parts on the device. Click on the item number in a diagram to jump to that part.
- The **Quantity** column identifies how many of the listed part is used in the assembly.
- **MIN** refers to the Physio-Control manufacturer's item number.
- **CAT.** number is used for ordering each part.
- The **Part Description** column provides a brief description of each part in the parts list.
- **PN** is the part number that identifies the model of each LIFEPAK 15 monitor/defibrillator.
- **Options** are assemblies that are not required on the basic device and can be specified by the customer when purchased. Parts on these assemblies may be referred to as optional parts.
- **V1** (Version 1) refers to LIFEPAK 15 devices that do **not** have the auxiliary power feature.
- **V2** (Version 2) refers to LIFEPAK 15 devices that have the auxiliary power feature. A device must be V2-equivalent to order the Temperature option.

### Main Diagrams

Use the following diagrams for an overview of the device:

- Assembly Diagram Configurator ([Figure 11.1 on p. 489](#))—shows the main parts of the device with links to detailed assembly diagrams.
- Interconnect Diagram ([Figure 11.2 on p. 490](#))—shows detailed assembly and cable interconnect information and provides links to each part diagram.

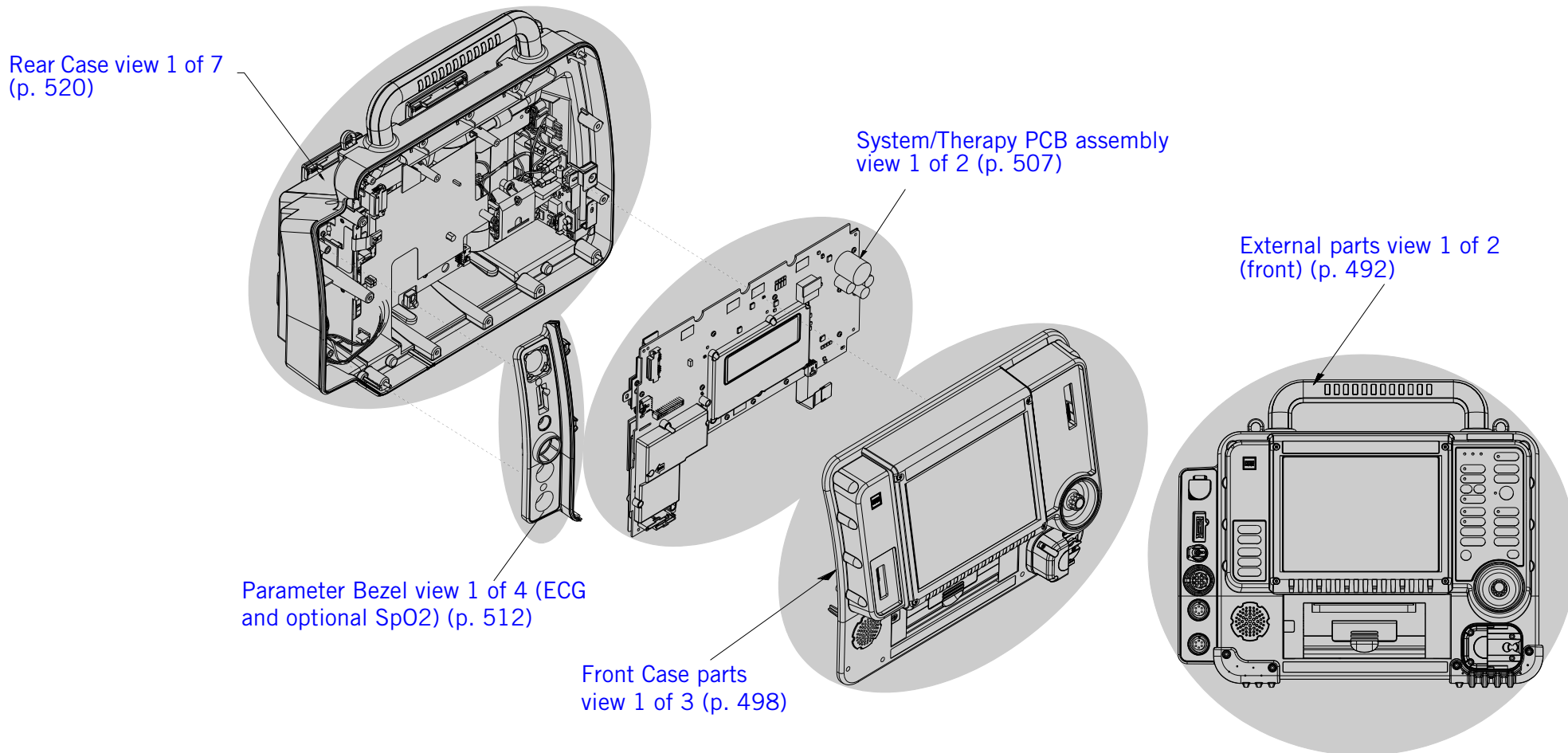

Figure 11.1—Assembly diagram configurator

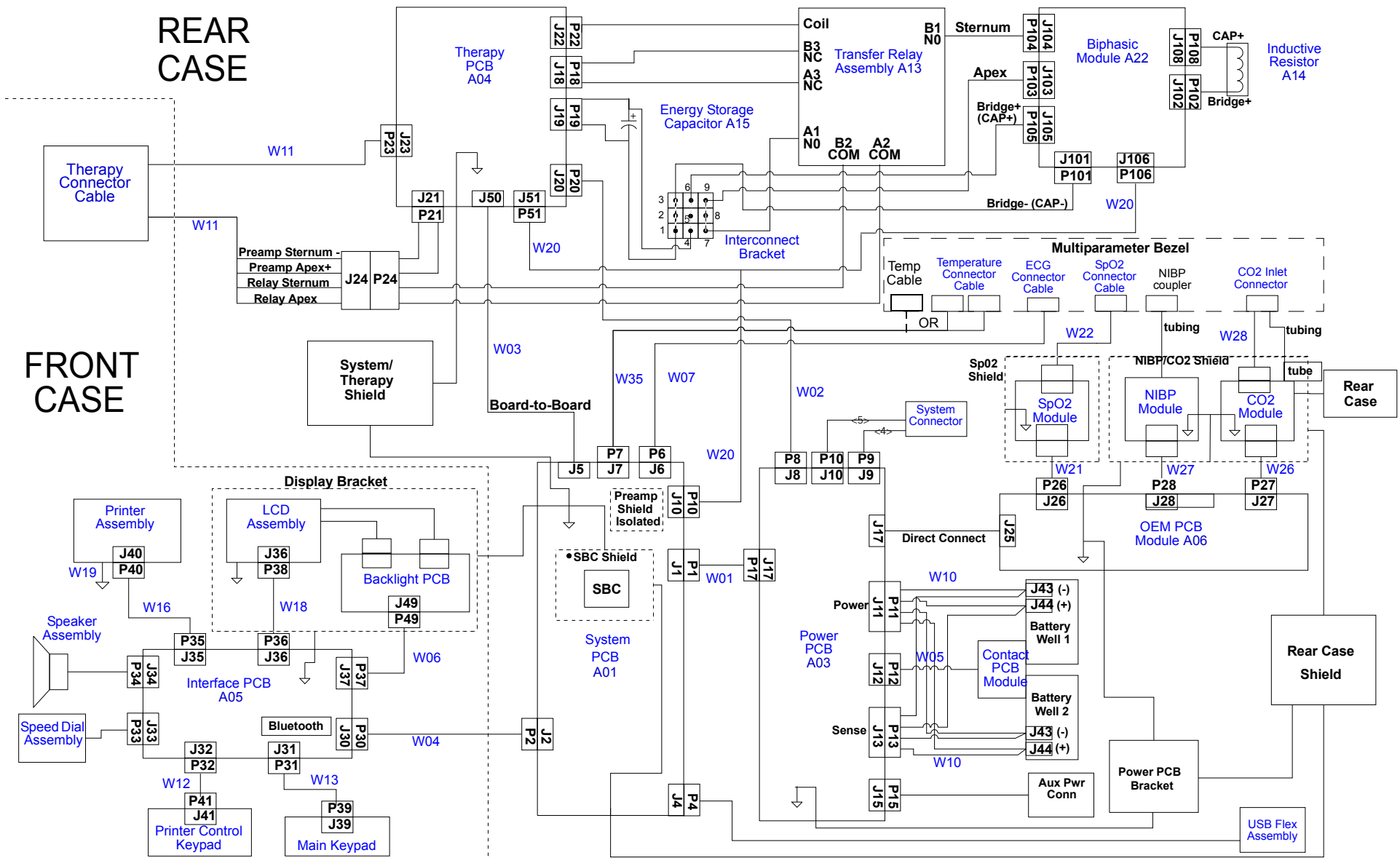

Figure 11.2—Interconnect diagram with detailed assembly, cable interconnect information, and links to each part diagram.

### External Parts Diagrams and Lists

External parts includes the following:

- [External and Configured Parts Diagram — Page 1 of 2 \(p. 492\)](#)
- [External and Configured Parts Diagram — Page 2 of 2 \(p. 493\)](#)
- [External Parts List \(p. 494\)](#)
- [Carrying Case Replacement Parts \(p. 496\)](#)

### External and Configured Parts Diagram — Page 1 of 2

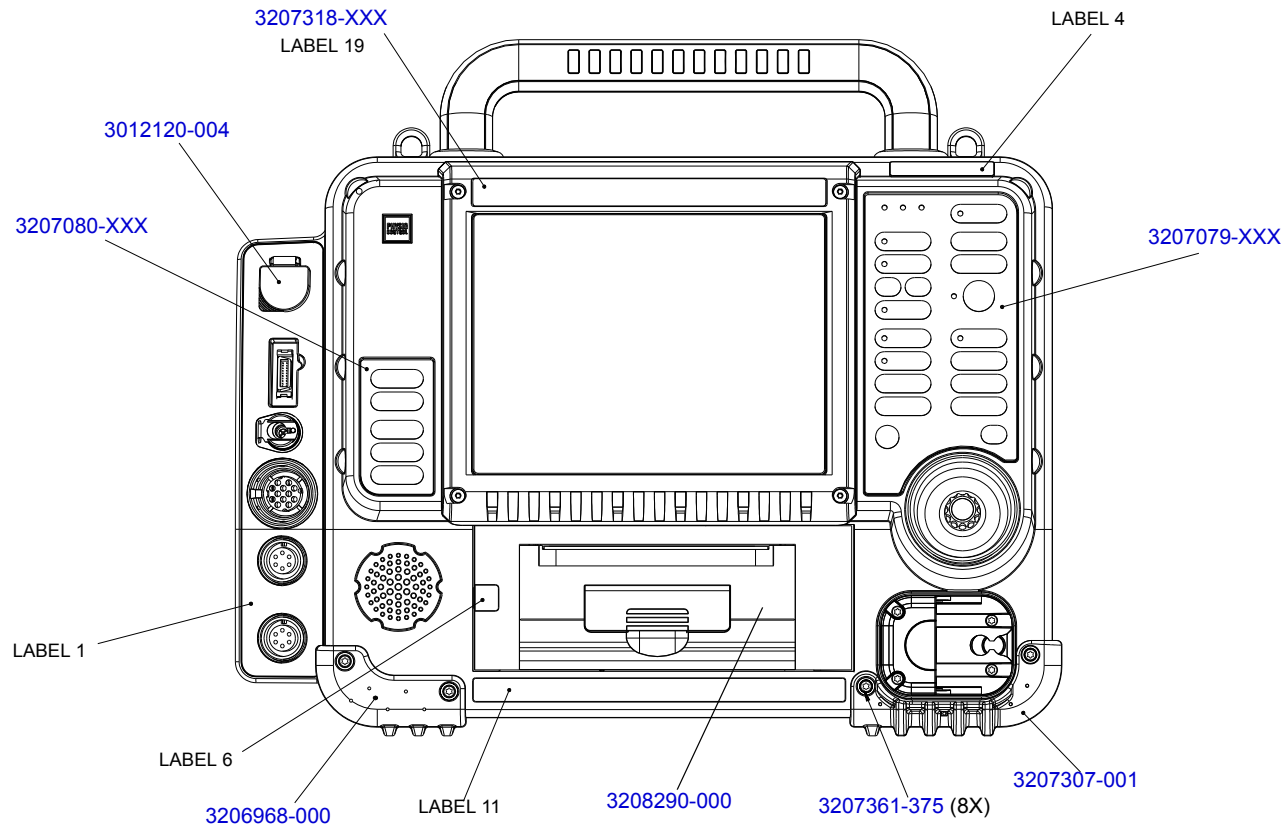

Figure 11.3—External parts view 1 of 2 (front)



### External and Configured Parts Diagram — Page 2 of 2

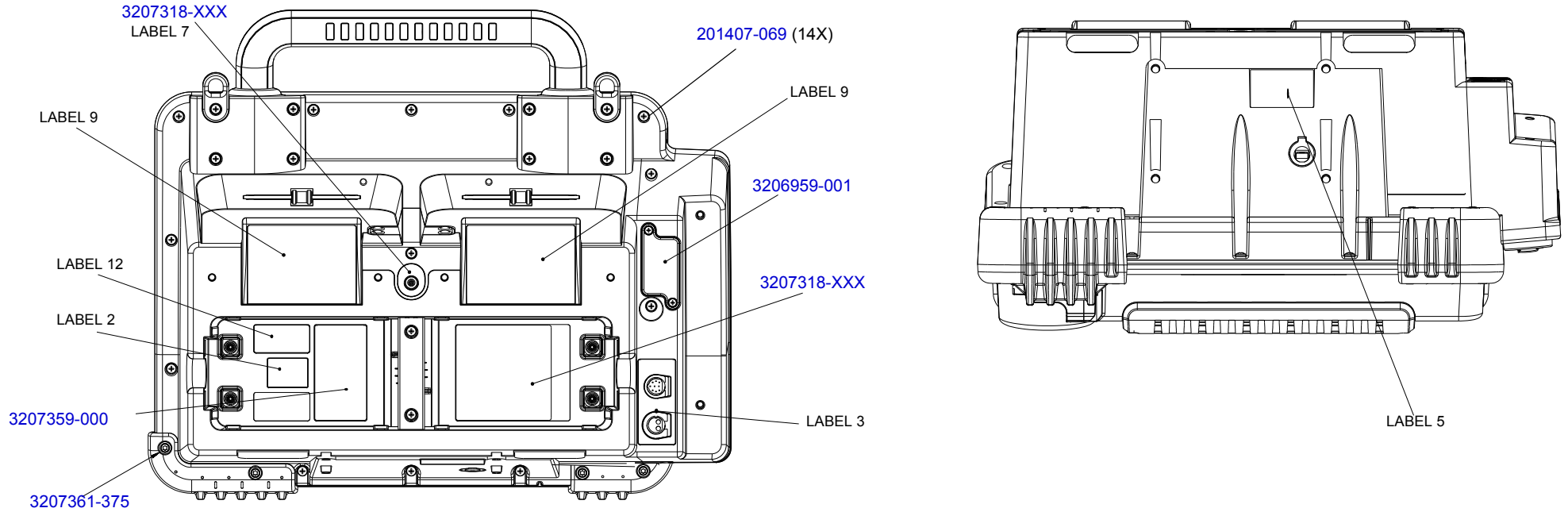

Figure 11.4—External parts view 2 of 2 (rear)

### External Parts List

Table 11.1—External Parts

MIN	CAT.	Qty	Description	Notes
3207318-XXX	Multiple	1	LABEL SET, language and feature-specific (V1 - No Auxiliary Power feature)	Refer to Label Set family drawing section, <a href="#">Figure 11.3 on p. 492</a> and <a href="#">Figure 11.4 on p. 493</a> . See <a href="#">LIFEPAK 15 Label Set - Languages (V1) (p. 544)</a>
3305642-XXX	Multiple	1	LABEL SET, language and feature-specific (V2 - Auxiliary Power feature)	Refer to Label Set family drawing section, <a href="#">Figure 11.3 on p. 492</a> and <a href="#">Figure 11.4 on p. 493</a> . See <a href="#">LIFEPAK 15 Label Set - Languages (V2) (p. 551)</a>
3207079-XXX	Multiple	1	A10 -KEYPAD ASSY -MAIN CNTRL (V1 - No Auxiliary Power feature)	Refer to <a href="#">Figure 11.3 on p. 492</a> . See <a href="#">A10 Main Keypad - Languages (V1) (p. 540)</a>
3302470-XXX	Multiple	1	A10 -KEYPAD ASSY - MAIN CNTRL (V2-- Auxiliary Power feature)	Refer to <a href="#">Figure 11.3 on p. 492</a> . See <a href="#">A10 Main Keypad - Languages (V2) (p. 542)</a>
3207080-XXX	Multiple	1	A09 - KEYPAD ASSY - PRINTER CONTROL	Refer to <a href="#">Figure 11.3 on p. 492</a> . See <a href="#">A09- Printer Control Keypad - Languages (p. 538)</a>
3012120-004	21300-007445	1	Cover - CO2 Connector	Refer to <a href="#">External and Configured Parts Diagram — Page 1 of 2 (p. 492)</a>
3208290-000	11241-000008	1	A12- PRINTER - 100 MM, GRAY	Refer to <a href="#">External and Configured Parts Diagram — Page 1 of 2 (p. 492)</a> . For cable interconnect view, see <a href="#">Figure 11.32 (p. 573)</a>
3206959-001	21330-001169	1	Door - Blank, USB	Refer to <a href="#">Figure 11.4 on p. 493</a>

**Table 11.1—External Parts (Continued)**

MIN	CAT.	Qty	Description	Notes
3207307-001	21300-007356	1	Bumper (guard) - Corner, Lower right	Refer to <a href="#">External and Configured Parts Diagram — Page 1 of 2 (p. 492)</a> .
3206968-000	21300-007010	1	Bumper (guard) - Corner, Lower left	Refer to <a href="#">External and Configured Parts Diagram — Page 1 of 2 (p. 492)</a> .
3207361-375	21300-007253	8	Screw-Cap, SCH, Rec, 15IP Torx Plus, 6-32x0.375L,SS	Refer to <a href="#">External and Configured Parts Diagram — Page 1 of 2 (p. 492)</a> and <a href="#">External and Configured Parts Diagram — Page 2 of 2 (p. 493)</a> .
3207131	21501-001997	1	LABEL - SERIAL NUMBER	Refer to <a href="#">External and Configured Parts Diagram — Page 2 of 2 (p. 493)</a>
3207359-000	21501-001993	1	LABEL - SpO2 MASIMO PATENT (For SpO2 option only)	Refer to <a href="#">External and Configured Parts Diagram — Page 2 of 2 (p. 493)</a>
201407-069	21300-000777	14	SCREW, SEAL-SEAL, SELF-LOCK, 6-32 X 0.375	Refer to <a href="#">External and Configured Parts Diagram — Page 2 of 2 (p. 493)</a>

### Carrying Case Replacement Parts

Replacement case parts include screws separately and the bag parts as shown in [Table 11.2](#) and [Table 11.3](#).

**Table 11.2—Screws for carrying cases**

Min	CAT.	Qty	Description	Device - Mounting
3207492-001	21300-007429	4	8-32 x 0.312" Screw, Trusshead, Phillips, SS, Nylok Patch	mounts carry case at device bottom
200476-708	21300-007966	2	¼-20 x 1.00" Screw, Panhead , Phillips, SS, Nylok Patch	mounts carry case at top holes
202253-576	21300-001033	4	6-32 x 0.75" Screw, Panhead, Phillips, SS, Nylok Patch	mounts on rear pouch

**Table 11.3—LIFEPAK15 Carrying Case Parts**

MIN	CAT.	Qty	Description	Notes
3207824-000	11577-000002	1	Standard Carry Case (w/ Shoulder Strap)	
3207827-002	11260-000039	1	Back Pouch	
3207823-000	11577-000001	1	Shoulder Strap	
3010267-00	11220-000028	1	Top Pouch	

### Front Parts Diagrams and Parts List

Use the following front parts diagrams and table to identify parts in the front case.

- [Front Case parts view 1 of 3 \(p. 498\)](#)
- [Front Case parts view 2 of 3 \(p. 499\)](#)
- [Front Case parts view 3 of 3 \(p. 500\)](#)
- [Front Parts List \(p. 501\)](#)

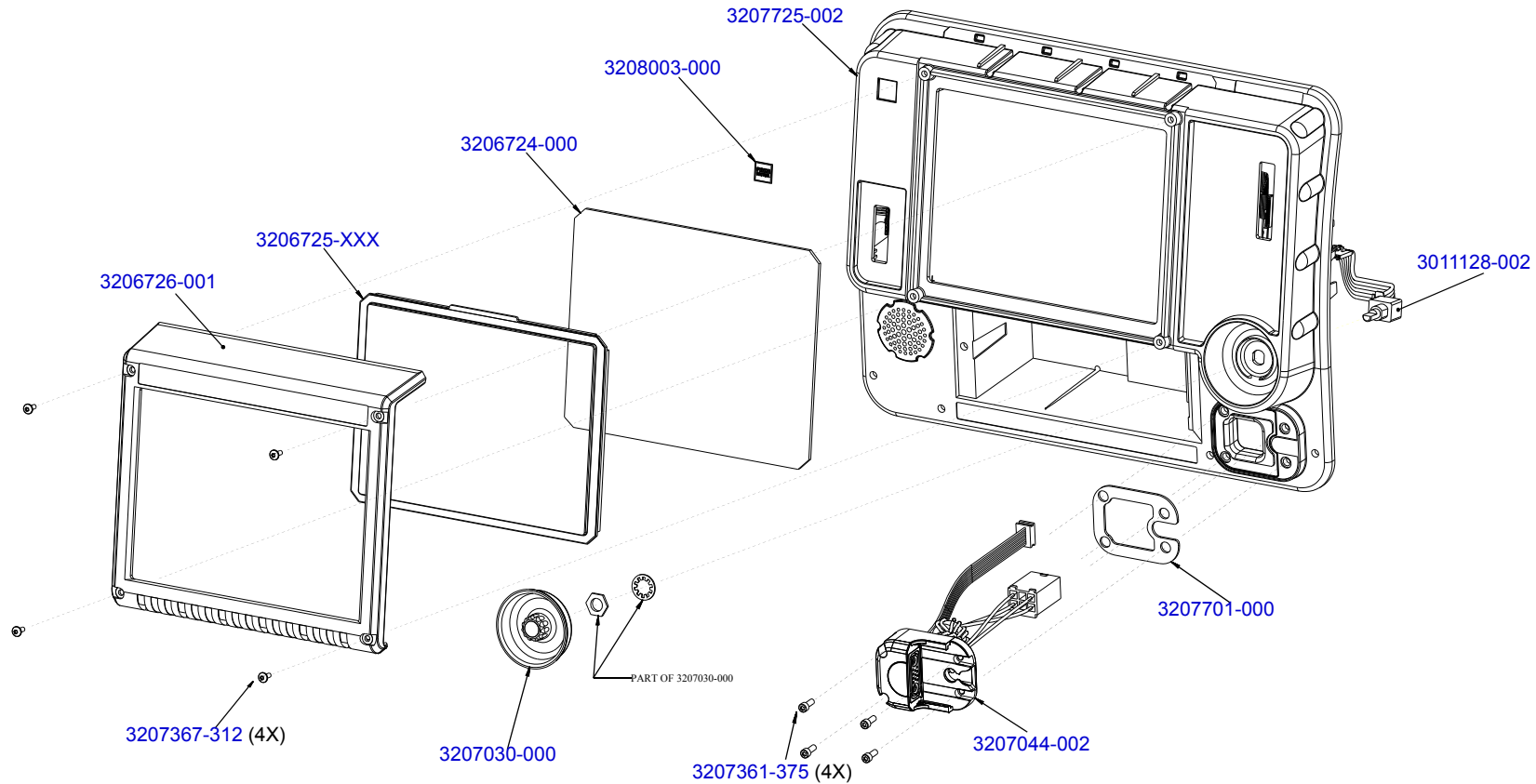

Figure 11.5—Front Case parts view 1 of 3

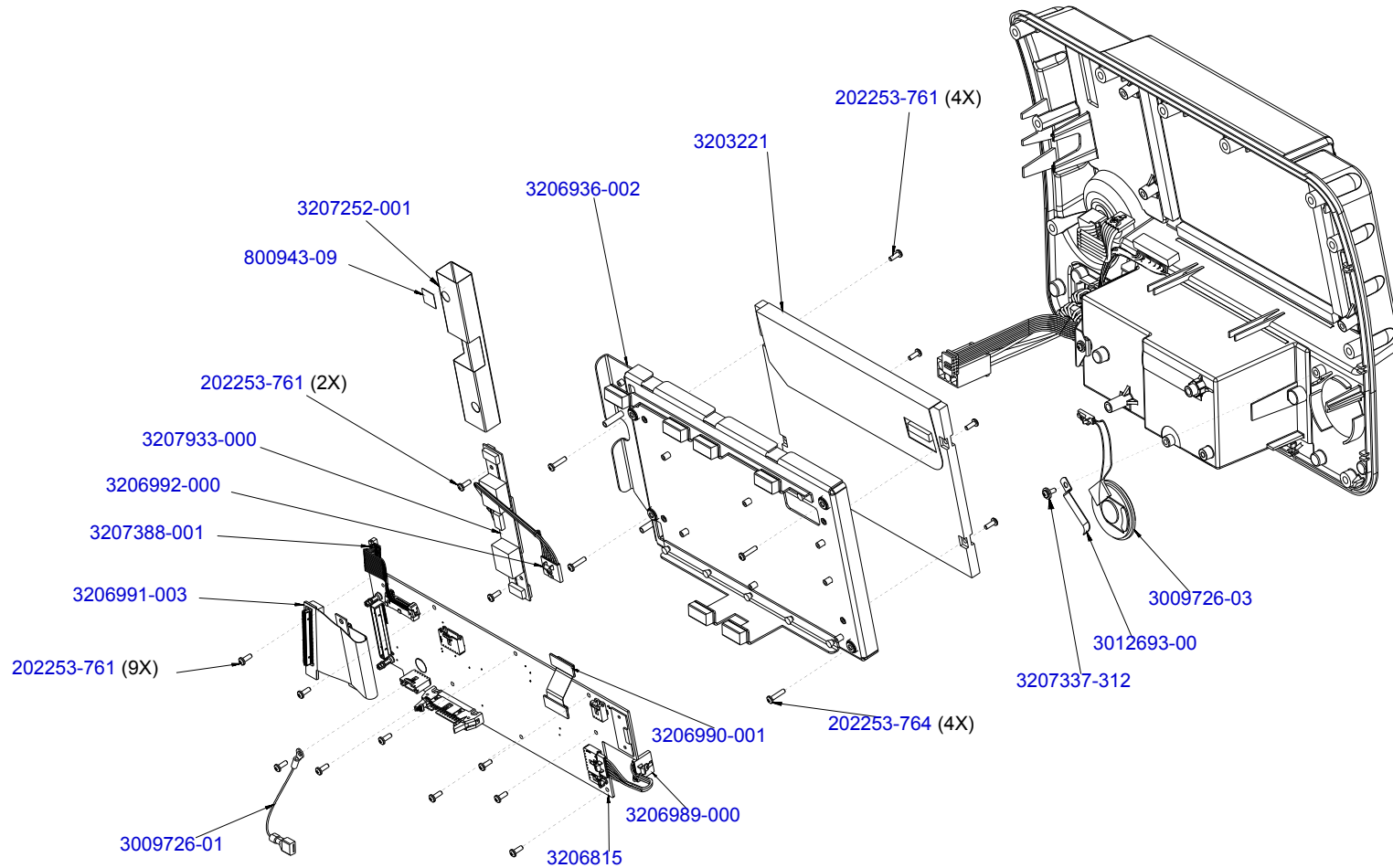

Figure 11.6—Front Case parts view 2 of 3

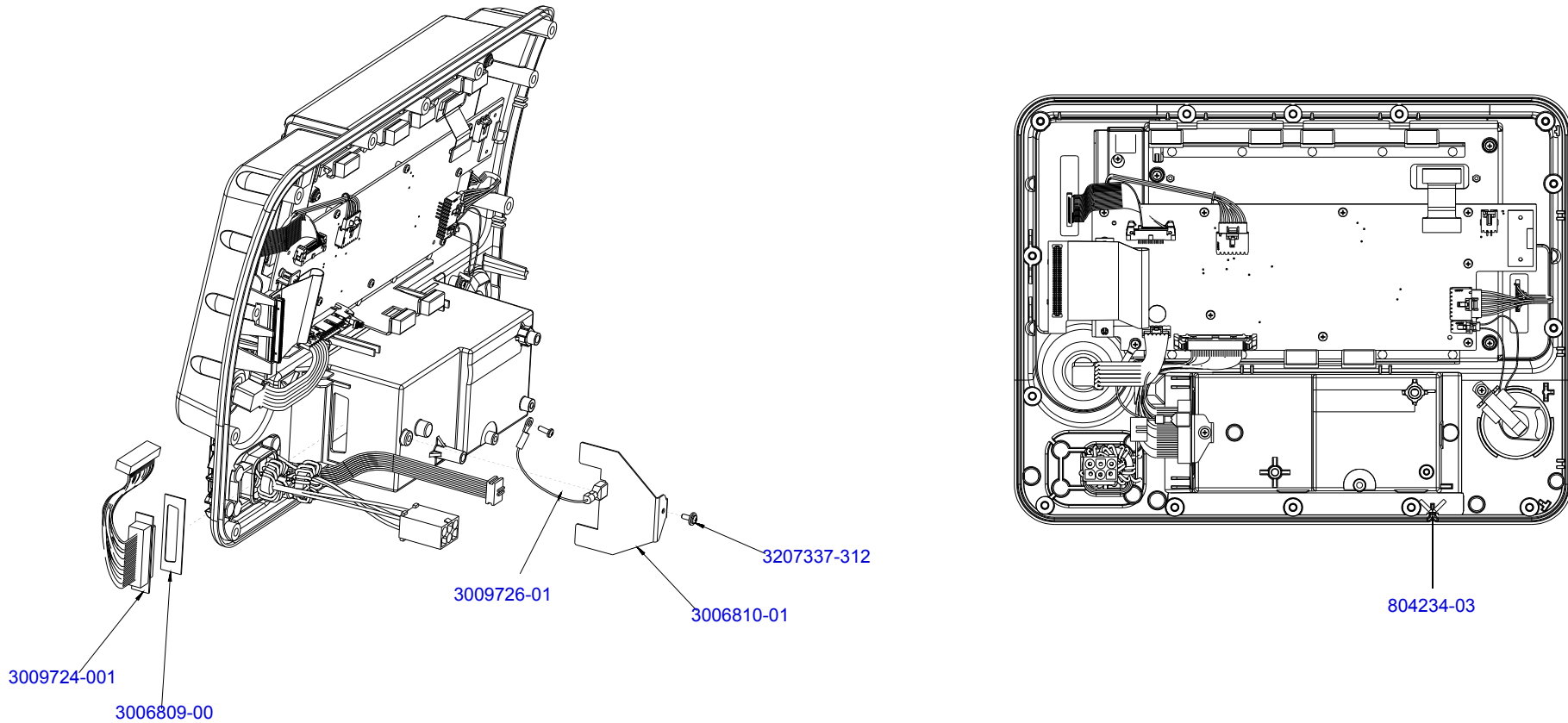

Figure 11.7—Front Case parts view 3 of 3



### Front Parts List

Table 11.4—Front Case Parts List

MIN	CAT.	Qty	Description	Notes
202253-761	21300-001038	15	SCREW-M,CS,Z,PH, NYLOCK,4-40 X .312L	Refer to <a href="#">Figure 11.6: Front Case parts view 2 of 3, p. 499</a> and <a href="#">Figure 11.7: Front Case parts view 3 of 3, p. 500</a> .
202253-764	21300-004599	4	SCREW,MACHINE,PANHEAD,NYLOK,4-40 X .500	Refer to <a href="#">Figure 11.6: Front Case parts view 2 of 3, p. 499</a> .
3006809-00	21300-001299	1	GASKET, PRINTER, SUB-D	Refer to <a href="#">Figure 11.7: Front Case parts view 3 of 3, p. 500</a> .
3006810-01	21300-006100	1	BRACKET, CONNECTOR, SUBD	Refer to <a href="#">Figure 11.7: Front Case parts view 3 of 3, p. 500</a> .
3009724-001	21330-000165	1	W16 - CABLE ASSY, RIBBON,INTERFACE PCB/CHART RCDR	Refer to <a href="#">Figure 11.7: Front Case parts view 3 of 3, p. 500</a> . For cable interconnect view, see <a href="#">Figure 11.56 on p. 597</a> .
3009726-01	21300-001370	1	W19 - WIRE HARNESS -GROUND/PRINTER BRKT	Refer to <a href="#">Figure 11.6: Front Case parts view 2 of 3, p. 499</a> and <a href="#">Figure 11.7: Front Case parts view 3 of 3, p. 500</a> . For cable interconnect view, see <a href="#">Figure 11.59 on p. 600</a>

**Table 11.4—Front Case Parts List (Continued)**

MIN	CAT.	Qty	Description	Notes
3009726-03	21300-001371	1	W17 - WIRE HARNESS-SPEAKER INTERFACE PCB	Refer to <a href="#">Figure 11.6: Front Case parts view 2 of 3, p. 499.</a> For cable interconnect view, see <a href="#">Figure 11.57 on p. 598.</a>
3011128-002	21300-003713	1	W15 - SWITCH-ROTARY	Refer to <a href="#">Figure 11.5: Front Case parts view 1 of 3, p. 498.</a>
3012693-00	21300-001575	1	SPRING,CLAMP, STAINLESS STEEL	Refer to <a href="#">Figure 11.6: Front Case parts view 2 of 3, p. 499.</a>
3203221	21300-007358	1	A11 - DISPLAY-ACTIVE MATRIX, 8.4 ,COLOR	Refer to <a href="#">Figure 11.6: Front Case parts view 2 of 3, p. 499.</a> For cable interconnect view, see <a href="#">Figure 11.31 on p. 572.</a> Repair kit, see <a href="#">Display Repair Kit (MIN 3305431-013) (p. 622)</a>
3206724-000	21330-001173	1	LENS-DISPLAY	Refer to <a href="#">Figure 11.7: Front Case parts view 3 of 3, p. 500.</a> Repair kit, see <a href="#">Front Case Repair Kit (MIN 3305431-023) (p. 628).</a>
3206725-XXX	21330-001174	1	SHIELD-DISPLAY	Refer to <a href="#">Figure 11.5: Front Case parts view 1 of 3, p. 498.</a> Repair kit, see <a href="#">Display Shield Repair Kit (MIN 3305431-018) (p. 625).</a>
3206726-001	21330-001168	1	FRAME - DISPLAY SHIELD	Refer to <a href="#">Figure 11.5: Front Case parts view 1 of 3, p. 498.</a> Repair kit, see <a href="#">Display Shield Repair Kit (MIN 3305431-018) (p. 625).</a>

**Table 11.4—Front Case Parts List (Continued)**

MIN	CAT.	Qty	Description	Notes
3206815	21330-001236	1	A05 - PCB ASSY - INTERFACE (V1)	Refer to <a href="#">Figure 11.6: Front Case parts view 2 of 3, p. 499.</a> For cable interconnect view, see <a href="#">Figure 11.25 (p. 566)</a> . Repair kit, see <a href="#">Interface PCBA Repair Kit, V1 (MIN 3305431-005)</a> (p. 616).
3306367	21330-001447	1	A05 - PCB ASSY - INTERFACE (V2)	Refer to <a href="#">Figure 11.6: Front Case parts view 2 of 3, p. 499.</a> For cable interconnect view, see <a href="#">Figure 11.25 (p. 566)</a> . Repair kit, see <a href="#">Interface PCBA Repair Kit, V2 (MIN 3305431-029)</a> (p. 634).
3206936-002	21330-001189	1	BRACKET - LCD DISPLAY MOUNTING	Refer to <a href="#">Figure 11.6: Front Case parts view 2 of 3, p. 499.</a>
3206989-000	21330-001214	1	W12 - CABLE ASSY - PRINTER CONTROL KEYPAD, INTERFACE PCB	Refer to <a href="#">Figure 11.6: Front Case parts view 2 of 3, p. 499.</a> For cable interconnect view, see <a href="#">Figure 11.52 (p. 593)</a> .
3206990-001	21330-001223	1	W18 - CABLE ASSY-FLEX,LCD,INTERFACE PCB	Refer to <a href="#">Figure 11.6: Front Case parts view 2 of 3, p. 499.</a> For cable interconnect view, see <a href="#">Figure 11.58 (p. 599)</a> .
3206991-003	21330-001226	1	W04 - CABLE ASSY - FLEX, SYSTEM PCB/INTERFACE PCB	Refer to <a href="#">Figure 11.6: Front Case parts view 2 of 3, p. 499.</a>

**Table 11.4—Front Case Parts List (Continued)**

MIN	CAT.	Qty	Description	Notes
3206992-000	21330-001215	1	W06 - CABLE ASSY-BACKLIGHT INV,INTERFACE PCB	Refer to <a href="#">Figure 11.6: Front Case parts view 2 of 3, p. 499</a> . For cable interconnect view, see <a href="#">Figure 11.46 (p. 587)</a> .
3207030-000	21300-007051	1	KNOB-ROTARY SWITCH	Refer to <a href="#">Figure 11.5: Front Case parts view 1 of 3, p. 498</a> .
3207044-002	21300-007463	1	W11 - WIRE HARNESS-THERAPY, INTERNAL	Refer to <a href="#">Figure 11.5: Front Case parts view 1 of 3, p. 498</a> . Repair kit, see <a href="#">Therapy Connector Repair Kit (MIN 3305431-009) (p. 620)</a>
3207252-001	21300-007079	1	SHIELD, INVERTER	Refer to <a href="#">Figure 11.6: Front Case parts view 2 of 3, p. 499</a> .
3207337-312	21300-007297	2	SCREW-MACH,PNH,PHH,NYLOCK,4-40, 0.312L, WSHR,CS,ZN	Refer to <a href="#">Figure 11.6: Front Case parts view 2 of 3, p. 499</a> and <a href="#">Figure 11.7: Front Case parts view 3 of 3, p. 500</a>
3207361-375	21300-007253	4	SCREW-CAP,SCH,REC 15IP TORX PLUS,6-32,0.375L,SS	Refer to <a href="#">Figure 11.5: Front Case parts view 1 of 3, p. 498</a> .
3207367-312	21300-007196	4	SCREW-MACH,TRH,T10 TORX,4-40,0.312L,SS	Refer to <a href="#">Figure 11.5: Front Case parts view 1 of 3, p. 498</a> .
3207388-001	21330-001323	1	W13 - CABLE-ASSY,MAIN KEYPAD,INTERFACE PCB	Refer to <a href="#">Figure 11.6: Front Case parts view 2 of 3, p. 499</a> . For cable interconnect view, see <a href="#">Figure 11.53 on p. 594</a> .

**Table 11.4—Front Case Parts List (Continued)**

MIN	CAT.	Qty	Description	Notes
3207701-000	21300-007464	1	SEAL-THERAPY RECEPTAC	Refer to <a href="#">Figure 11.5: Front Case parts view 1 of 3, p. 498.</a>
3207725-002	21330-001273	1	ASSEMBLY-ENCLOSURE,FRONT	Refer to <a href="#">Figure 11.5: Front Case parts view 1 of 3, p. 498.</a> Repair kit, see <a href="#">Front Case Repair Kit (MIN 3305431-023) (p. 628).</a>
3207933-000	21300-007555	1	A08 - INVERTER-BACKLIGHT,DUALTUBE,12VDC,85C	Refer to <a href="#">Figure 11.6: Front Case parts view 2 of 3, p. 499.</a> Repair kit, see <a href="#">Backlight Inverter Repair Kit (MIN 3305431-012) (p. 622)</a>
3208003-000	21501-002038	1	LABEL-PHYSIO-CONTROL ICON	Refer to <a href="#">Figure 11.5: Front Case parts view 1 of 3, p. 498.</a>
800943-09	21501-000248	1	LABEL-SYMBOL,INT'L	Refer to <a href="#">Figure 11.6: Front Case parts view 2 of 3, p. 499.</a>
804234-03	21300-002394	1	SEAL-PERIMETER,CASE	Refer to <a href="#">Figure 11.6: Front Case parts view 2 of 3, p. 499.</a>

### System/Therapy PCB Assembly Diagrams and Parts Lists

Refer to the following diagrams and parts lists for assemblies.

- [System/Therapy PCB Assembly Diagrams and Parts List \(p. 507\)](#) includes:
  - ~ [System/Therapy PCB assembly view 1 of 2 \(p. 507\)](#)
  - ~ [System/Therapy PCB assembly view 2 of 2 \(p. 508\)](#)
  - ~ [System/Therapy Assembly Part Numbers \(p. 509\)](#)

### System/Therapy PCB Assembly Diagrams and Parts List

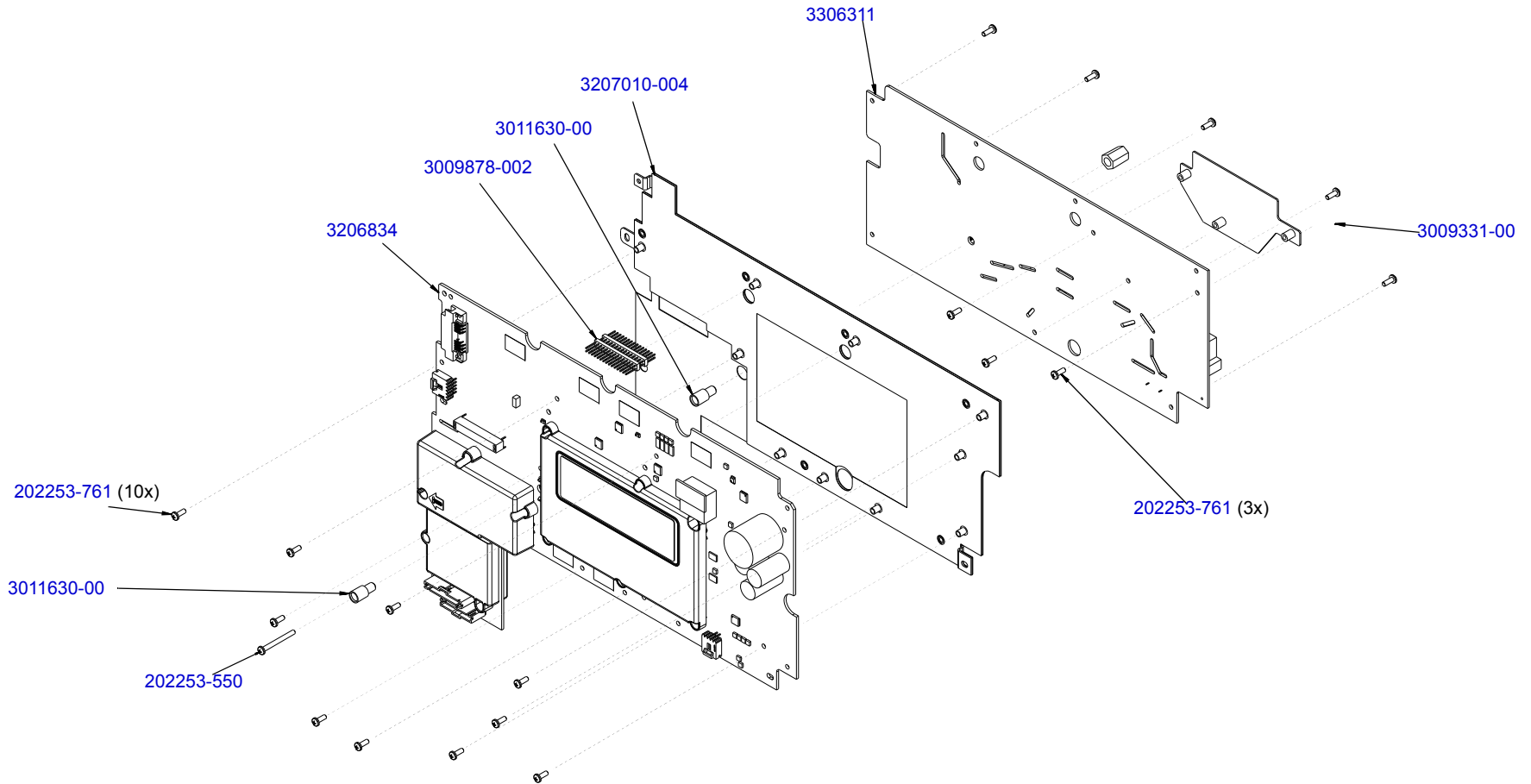

Figure 11.8—System/Therapy PCB assembly view 1 of 2

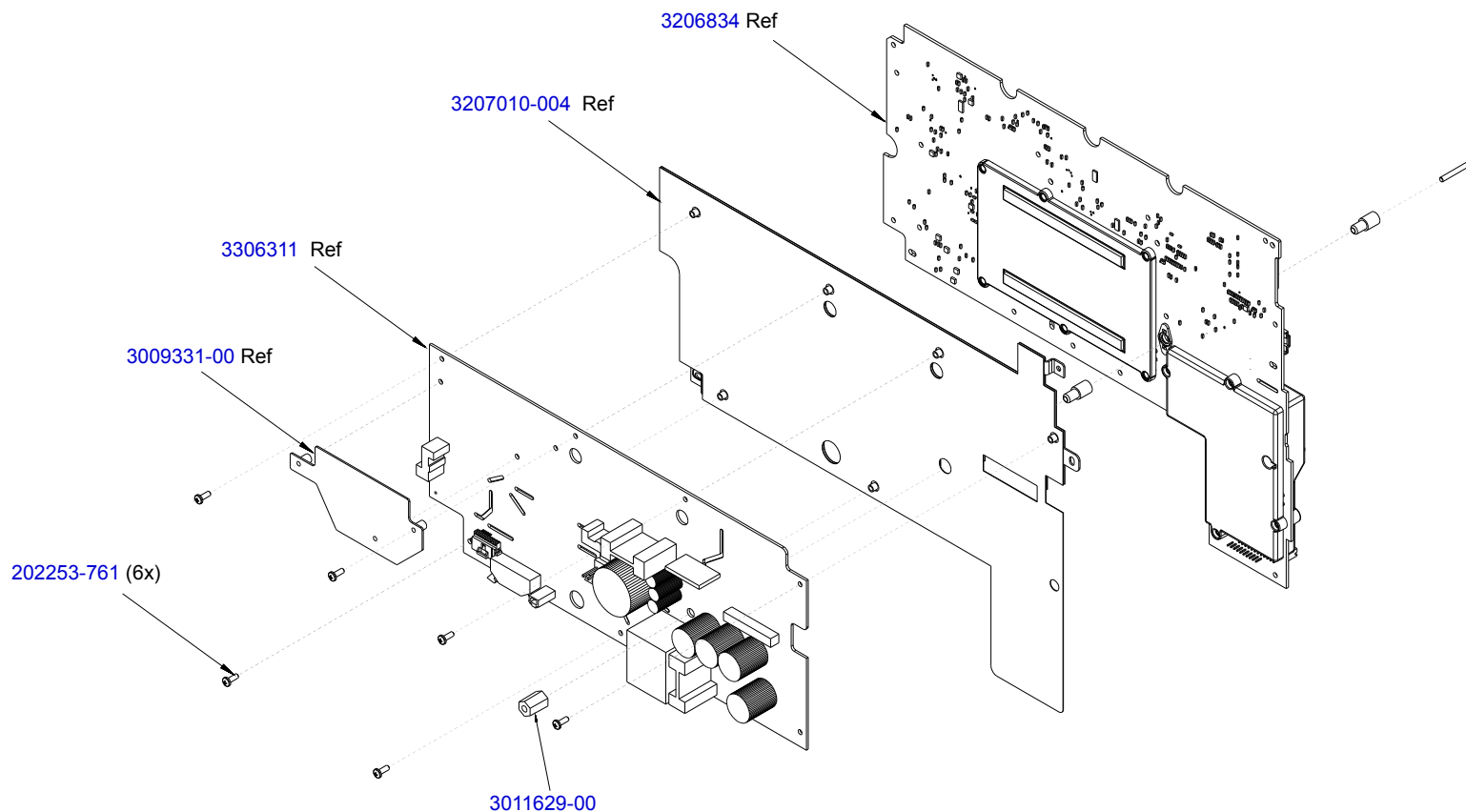

Figure 11.9—System/Therapy PCB assembly view 2 of 2



**Table 11.5—System/Therapy Assembly Part Numbers**

MIN	CATs	Qty	Description	Notes
202253-550	21300-001030	1	SCREW-PH, NYLOCK, PHIL,SS,4-40X.1.125L	See <a href="#">System/Therapy PCB Assembly Diagrams and Parts List (p. 507)</a>
202253-761	21300-001038	19	SCREW-M,CS,Z,PH, NYLOCK,4-40 X .312L	See <a href="#">System/Therapy PCB Assembly Diagrams and Parts List (p. 507)</a> and <a href="#">Figure 11.9: System/Therapy PCB assembly view 2 of 2, p. 508.</a>
3306311	21330-001449	1	A04 - PCB ASSY - THERAPY, BIPHASIC	See <a href="#">System/Therapy PCB Assembly Diagrams and Parts List (p. 507)</a> and <a href="#">Figure 11.9: System/Therapy PCB assembly view 2 of 2, p. 508.</a> For cable interconnect view, see <a href="#">Figure 11.22 on p. 563.</a> Repair kit see <a href="#">Therapy PCBA Repair Kit (MIN 3305431-008) (p. 619).</a>
3009331-00	21300-001343	1	SHIELD EMI, THERAPY PCB	See <a href="#">Figure 11.8: System/Therapy PCB assembly view 1 of 2, p. 507.</a>
3009878-002	21300-001379	1	W03 - CONN-HDR, SQUAREPIN DUAL ROW, 30 PIN	See <a href="#">Figure 11.8: System/Therapy PCB assembly view 1 of 2, p. 507.</a> For cable interconnect view, see <a href="#">Figure 11.43 on p. 584</a>
3011629-00	21300-001478	1	INSERT-HEX	See <a href="#">Figure 11.9: System/Therapy PCB assembly view 2 of 2, p. 508.</a>

Table 11.5—System/Therapy Assembly Part Numbers (Continued)

MIN	CATs	Qty	Description	Notes
3011630-00	21300-001479	2	SPACER-PCB	See <a href="#">System/Therapy PCB Assembly Diagrams and Parts List (p. 507)</a> .
3206834	21330-001448	1	A01 - PCB ASSY - SYSTEM	See <a href="#">System/Therapy PCB Assembly Diagrams and Parts List (p. 507)</a> . For cable interconnect view, see <a href="#">Figure 11.24 on p. 565</a> . Repair kit see <a href="#">System PCBA Repair Kit, V1 (MIN 3305431-007) (p. 618)</a> .
3207010-004	21330-001318	1	ASSY-MOUNTING, BRACKET, SYSTEM, THERAPY PCB	See <a href="#">System/Therapy PCB Assembly Diagrams and Parts List (p. 507)</a> .
804447-27	21300-003172	1	SPACER-FOAM, SYS PCB CAPS	See <a href="#">System/Therapy PCB Assembly Diagrams and Parts List (p. 507)</a> .
202305-000	21300-001052	1	COIN CELL BATTERY	

### Parameter Bezel Diagrams and Parts Lists

Refer to the following diagrams and parts lists for assemblies.

- [Parameter Bezel Diagrams and Parts List \(p. 512\)](#) includes:
  - ~ [Parameter Bezel view 1 of 4 \(ECG and optional SpO2\) \(p. 512\)](#)
  - ~ [Parameter Bezel view 2 of 4 \(optional CO2 and NIBP\) \(p. 513\)](#)
  - ~ [Parameter Bezel view 3 of 4 \(optional invasive pressure\) \(p. 514\)](#)
  - ~ [Parameter Bezel Parts List \(p. 516\)](#)

### Parameter Bezel Diagrams and Parts List

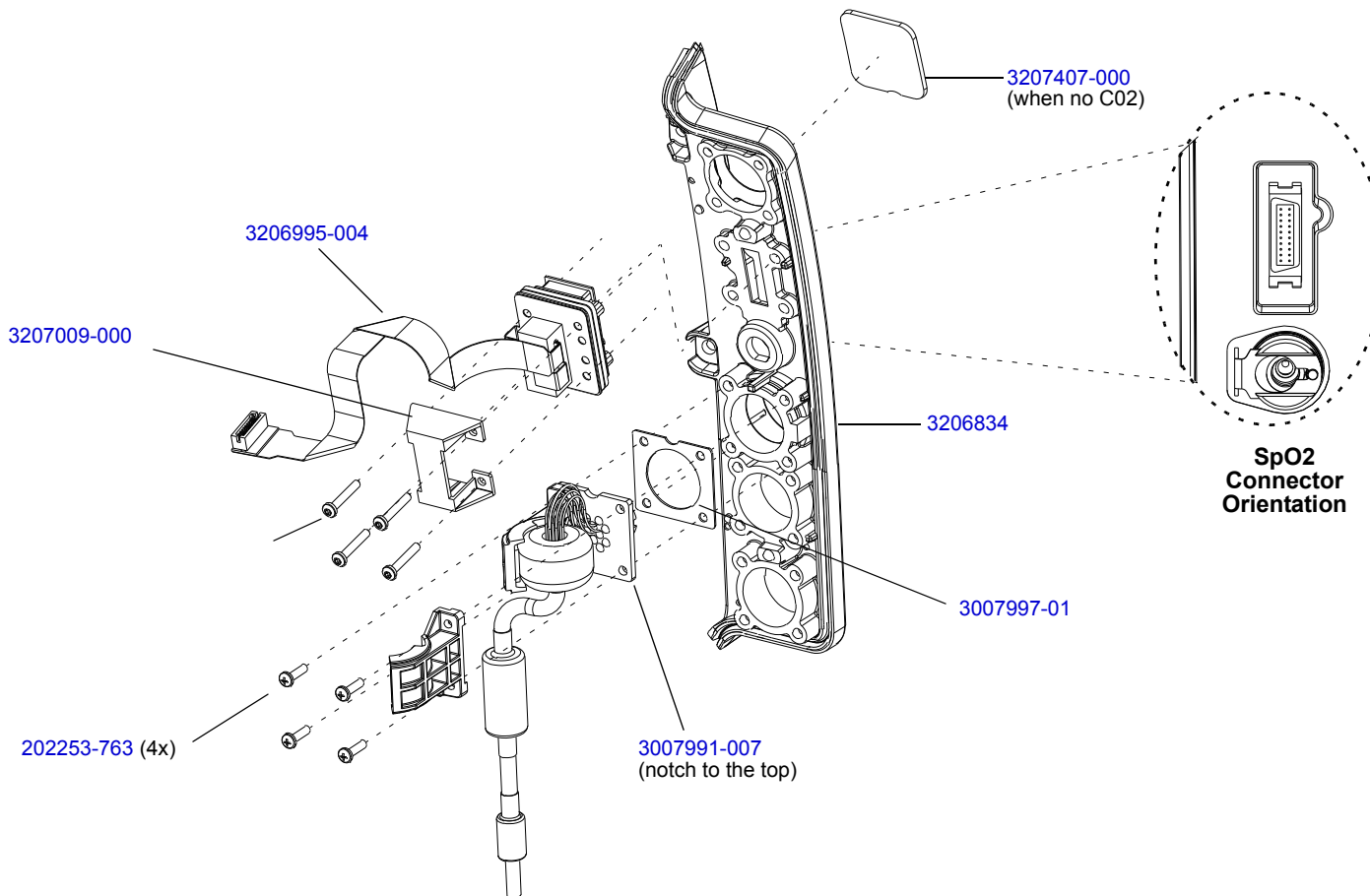

Figure 11.10—Parameter Bezel view 1 of 4 (ECG and optional SpO2)

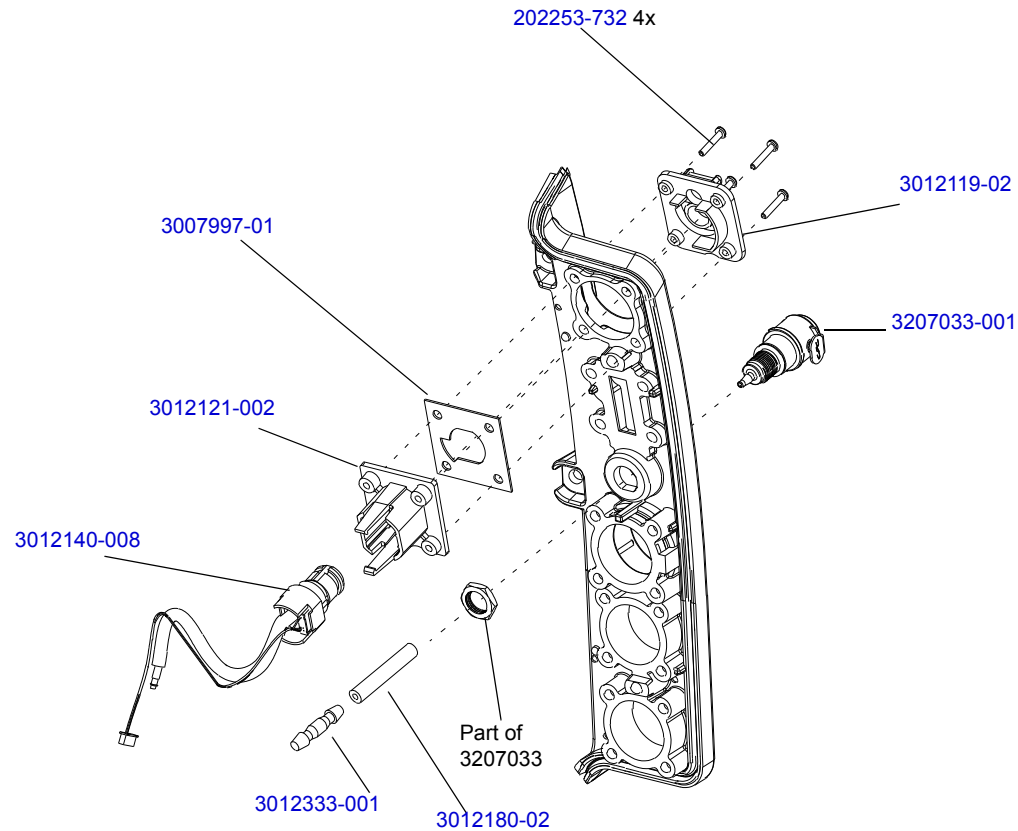

Figure 11.11—Parameter Bezel view 2 of 4 (optional CO2 and NIBP)

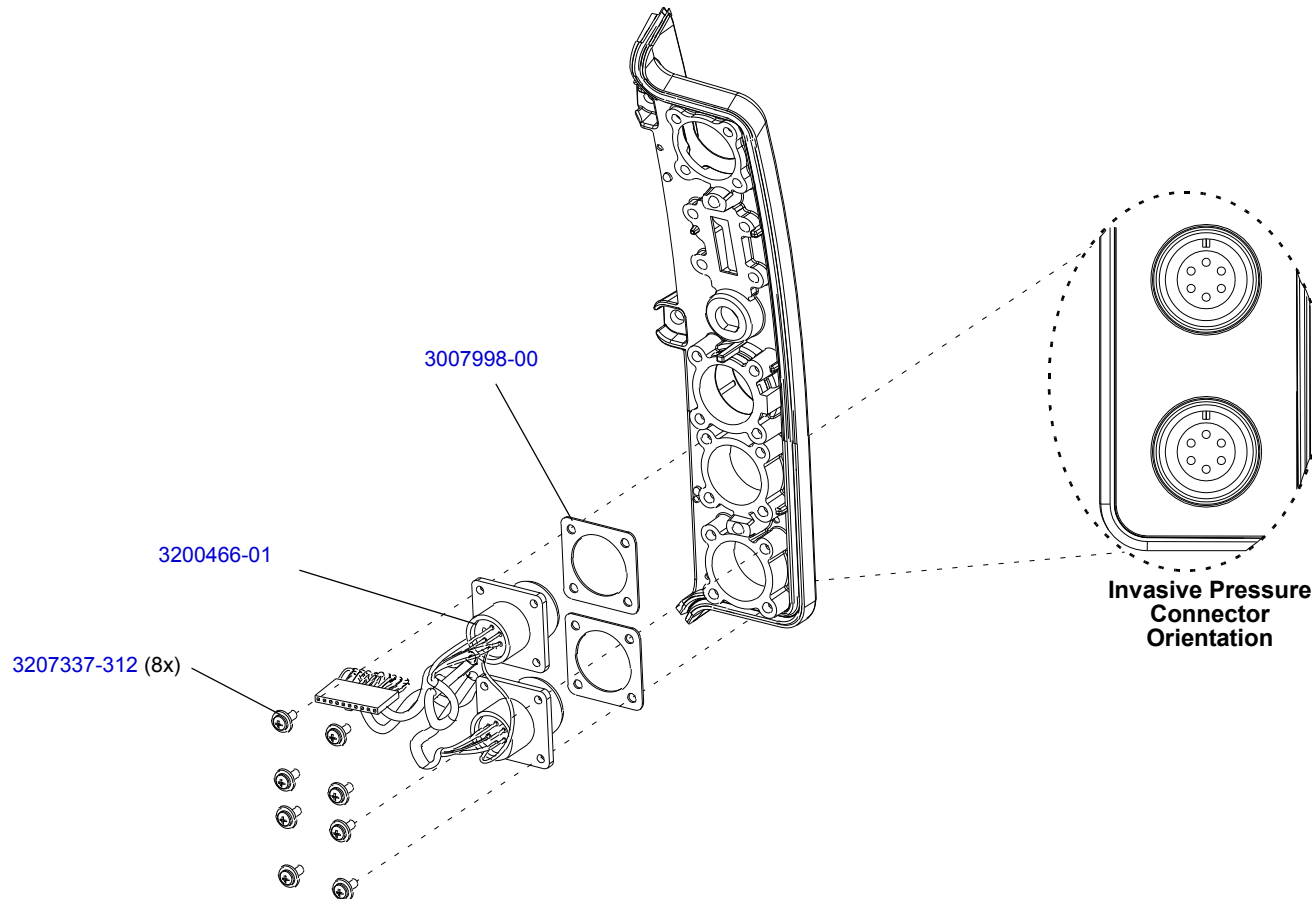

Figure 11.12—Parameter Bezel view 3 of 4 (optional invasive pressure)

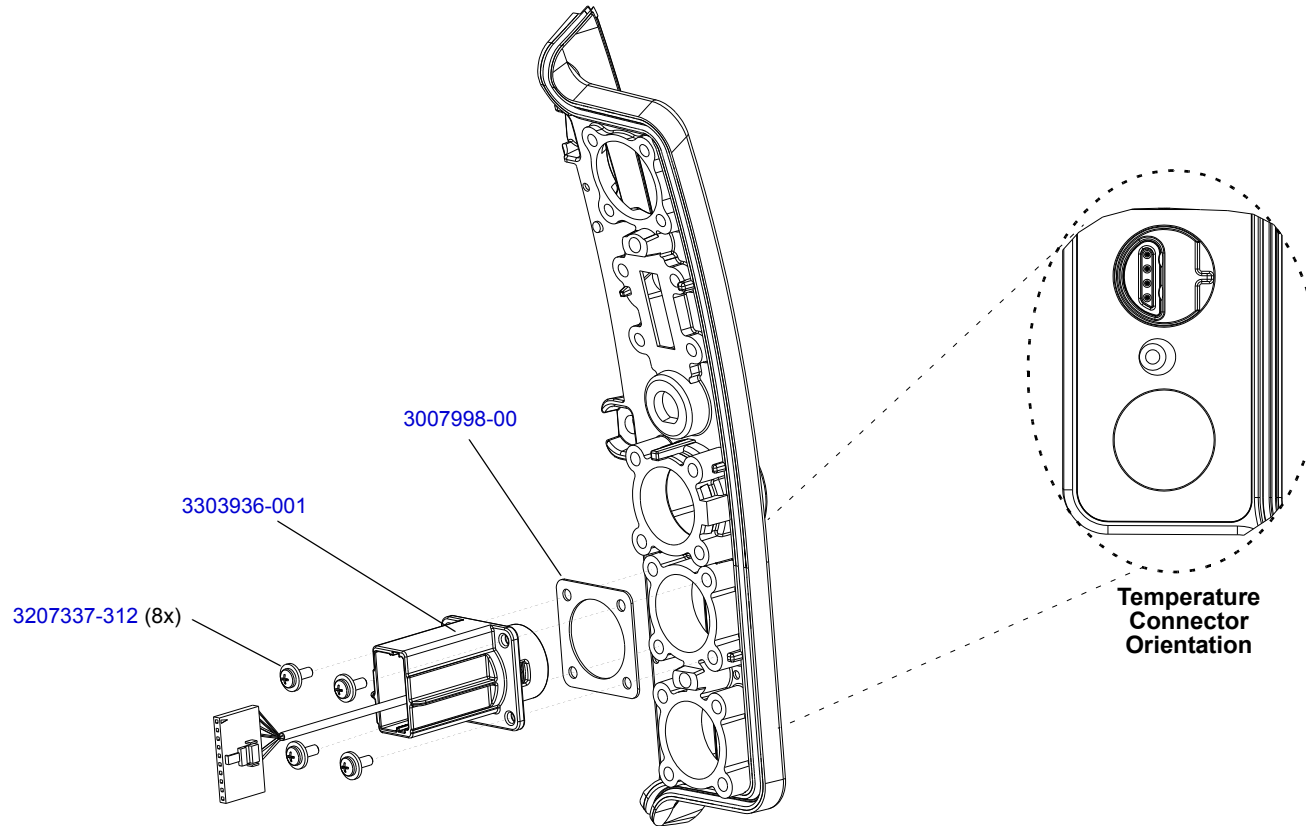

Figure 11.13—Parameter Bezel view 4 of 4 (optional temperature cable assembly)

**Table 11.6—Parameter Bezel Parts List**

MIN	CAT.	Qty.	Description	Notes
3207407-000	21300-007362	1	SPACER - CONNECTOR, CO2	This spacer is used in devices without CO2 feature. Refer to <a href="#">Figure 11.10: Parameter Bezel view 1 of 4 (ECG and optional SpO2)</a> , p. 512.
3206723-005	21330-001211	1	BEZEL - PARAMETER	Refer to <a href="#">Parameter Bezel Diagrams and Parts List</a> (p. 512), <a href="#">Figure 11.10: Parameter Bezel view 1 of 4 (ECG and optional SpO2)</a> , p. 512, and <a href="#">Figure 11.12: Parameter Bezel view 3 of 4 (optional invasive pressure)</a> , p. 514.
3007991-007	21300-006323	1	W07 - ECG CABLE ASSY, 12 CONTACT	Refer to <a href="#">Figure 11.10: Parameter Bezel view 1 of 4 (ECG and optional SpO2)</a> , p. 512. For cable interconnect view, see <a href="#">Figure 11.47</a> on p. 588. Repair kit, see <a href="#">ECG Connector Repair Kit (MIN 3305431-010)</a> (p. 620).
805915-01	21300-002683	1	SEAL-ECG RECEPTACLE	Refer to <a href="#">Figure 11.10: Parameter Bezel view 1 of 4 (ECG and optional SpO2)</a> , p. 512.
3205680-001	21300-006304	2	BRACKET - CABLE SUPPORT, ASSY	Refer to <a href="#">Figure 11.10: Parameter Bezel view 1 of 4 (ECG and optional SpO2)</a> , p. 512.
202253-763	21300-006965	4	SCREW, MACHINE, PANHEAD, NYLOK, 4-40 X .437	Refer to <a href="#">Figure 11.10: Parameter Bezel view 1 of 4 (ECG and optional SpO2)</a> , p. 512.
3206995-004	21330-001290	1	W22 - CABLE ASSY - FLEX, MASIMO, SpO2	Refer to <a href="#">Figure 11.10: Parameter Bezel view 1 of 4 (ECG and optional SpO2)</a> , p. 512. For cable interconnect view, see <a href="#">Figure 11.62</a> on p. 603. Repair kit, see <a href="#">OEM PCBA Repair Kit, V1 (MIN 3305431-004)</a> (p. 615).



**Table 11.6—Parameter Bezel Parts List (Continued)**

MIN	CAT.	Qty.	Description	Notes
3207009-000	21300-007112	1	HOUSING-FERRITE, SpO2	Refer to <a href="#">Figure 11.10: Parameter Bezel view 1 of 4 (ECG and optional SpO2)</a> , p. 512.
3205311-001	21300-007557	4	SCREW-MACHINE, PAN, T10 - TORX, NYLOK, 4-40 X 0.6875L (SpO2)	Refer to <a href="#">Figure 11.10: Parameter Bezel view 1 of 4 (ECG and optional SpO2)</a> , p. 512.
3012140-008	21300-007468	1	W28 - FRS ASSEMBLY - CO2, MINI-MODULE, LIFEPAK15	Refer to <a href="#">Figure 11.11: Parameter Bezel view 2 of 4 (optional CO2 and NIBP)</a> , p. 513. For cable interconnect view, see <a href="#">Figure 11.65</a> on p. 606. Repair kit, see <a href="#">CO2 Connector Repair Kit (MIN 3305431-014)</a> (p. 623).
3007997-01	21300-001314	1	SEAL - CO2 CONNECTOR	Refer to <a href="#">Figure 11.11: Parameter Bezel view 2 of 4 (optional CO2 and NIBP)</a> , p. 513.
3012119-02	21300-001548	1	ADAPTER - CO2 CONNECTOR	Refer to <a href="#">Figure 11.11: Parameter Bezel view 2 of 4 (optional CO2 and NIBP)</a> , p. 513.
3012121-002	21300-007998	1	RETAINER - CO2 CONN	Refer to <a href="#">Figure 11.11: Parameter Bezel view 2 of 4 (optional CO2 and NIBP)</a> , p. 513.
202253-732	21300-007353	4	SCREW-MACH, NYLOK, PHH, 2-56 X 0.500, CS, ZN (CO2)	Refer to <a href="#">Figure 11.11: Parameter Bezel view 2 of 4 (optional CO2 and NIBP)</a> , p. 513.
3207033-001	21300-007425	1	CONNECTOR - PNEUMATIC COUPLER, NIBP	Refer to <a href="#">Figure 11.11: Parameter Bezel view 2 of 4 (optional CO2 and NIBP)</a> , p. 513. Repair kit, see <a href="#">NIBP Connector Repair Kit (MIN 3305431-022)</a> (p. 627).
3012180-02	21300-001560	1	TUBING - NIBP	Refer to <a href="#">Figure 11.11: Parameter Bezel view 2 of 4 (optional CO2 and NIBP)</a> , p. 513.

**Table 11.6—Parameter Bezel Parts List (Continued)**

MIN	CAT.	Qty.	Description	Notes
3012333-001	21300-001566	1	CONN-PNEU, STR, 0.125ID NYLON, WHT (NIBP)	Refer to <a href="#">Figure 11.11: Parameter Bezel view 2 of 4 (optional CO2 and NIBP)</a> , p. 513.
3200466-01	21300-001583	1	W33 - WIRE HARNESS- INVASIVE PRESSURE 1- 2	Refer to <a href="#">Figure 11.12: Parameter Bezel view 3 of 4 (optional invasive pressure)</a> , p. 514. For cable interconnect view, see <a href="#">Figure 11.68 on p. 609</a> . Repair kit, see <a href="#">Invasive Pressure Connector Repair Kit (MIN 3305431-001)</a> (p. 613).
3007998-00	21300-001315	2	GASKET - CONNECTOR, INVASIVE PRESURE	Refer to <a href="#">Figure 11.12: Parameter Bezel view 3 of 4 (optional invasive pressure)</a> , p. 514 and <a href="#">Figure 11.13: Parameter Bezel view 4 of 4 (optional temperature cable assembly)</a> , p. 515.
3207337-312	21300-007297	8	SCREW-MACH,PNH,PHH, NYLOCK, 4-40 X 0.312L, WSHR,CS,ZN (IP)	Refer to <a href="#">Figure 11.12: Parameter Bezel view 3 of 4 (optional invasive pressure)</a> , p. 514.
3303936-001	21330-001484	1	W35 - CONNECTOR CABLE ASSEMBLY - TEMPERATURE	Refer to <a href="#">Figure 11.13: Parameter Bezel view 4 of 4 (optional temperature cable assembly)</a> , p. 515.

### Rear Diagrams and Parts List

Use the following diagrams and parts list to identify parts in the rear case.

- [Rear Case view 1 of 7 \(p. 520\)](#)
- [Rear Case view 2 of 7 \(p. 521\)](#)
- [Rear Case view 3 of 7 \(p. 522\)](#)
- [Rear Case view 4 of 7 \(p. 523\)](#)
- [Rear Case view 5 of 7 \(p. 524\)](#)
- [Rear Case view 6 of 7 \(p. 525\)](#)
- [Rear Case view 7 of 7 \(p. 526\)](#)
- [Rear Parts List \(p. 527\)](#)

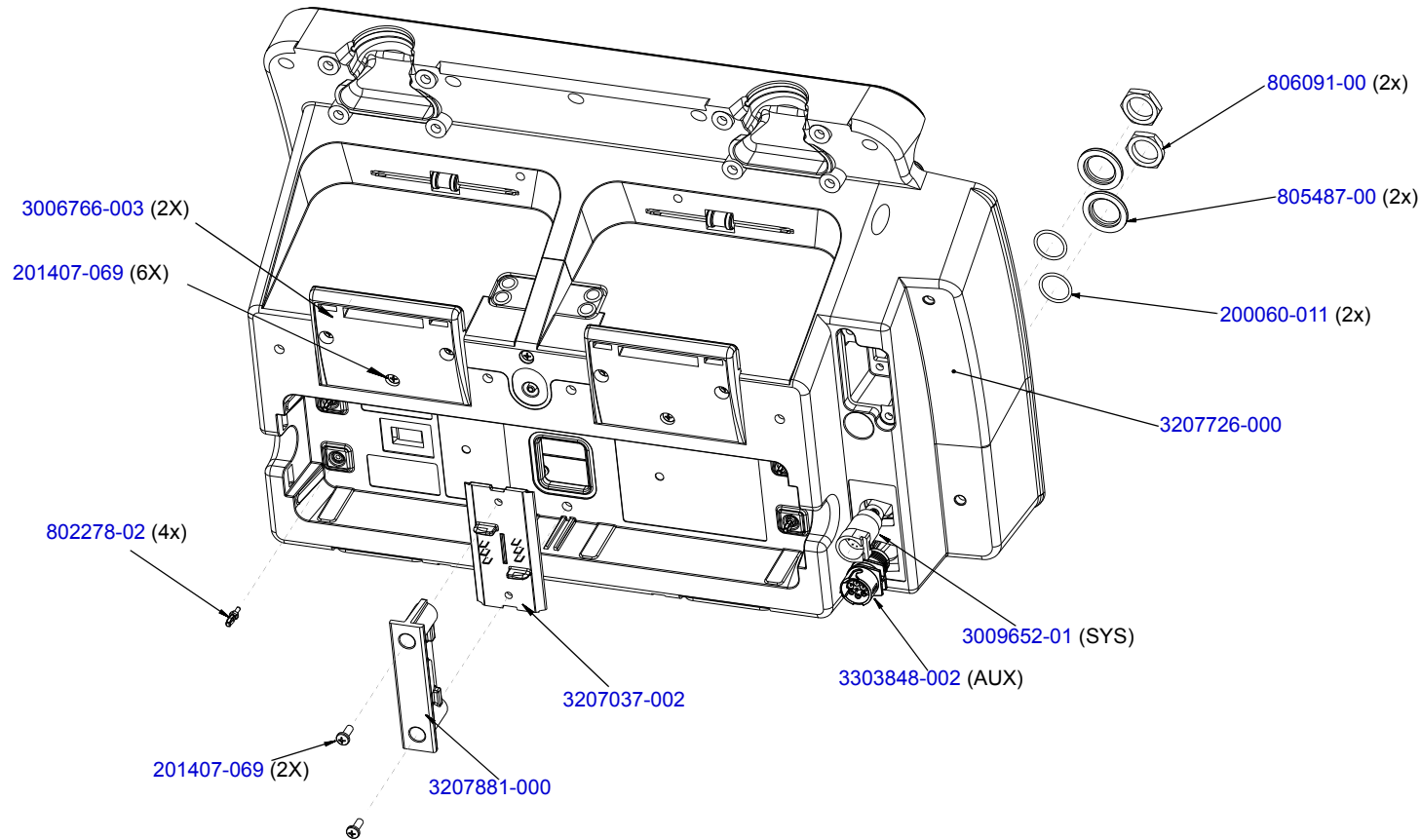

Figure 11.14—Rear Case view 1 of 7

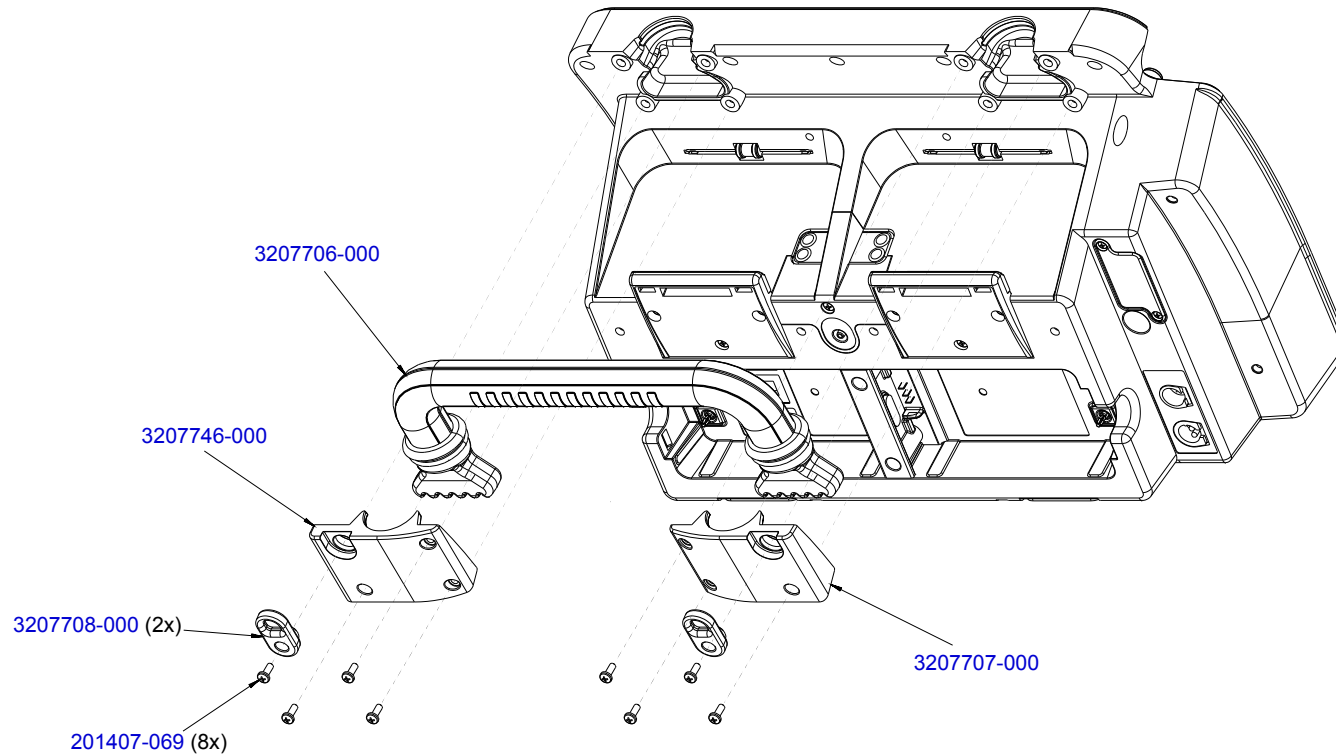

Figure 11.15—Rear Case view 2 of 7

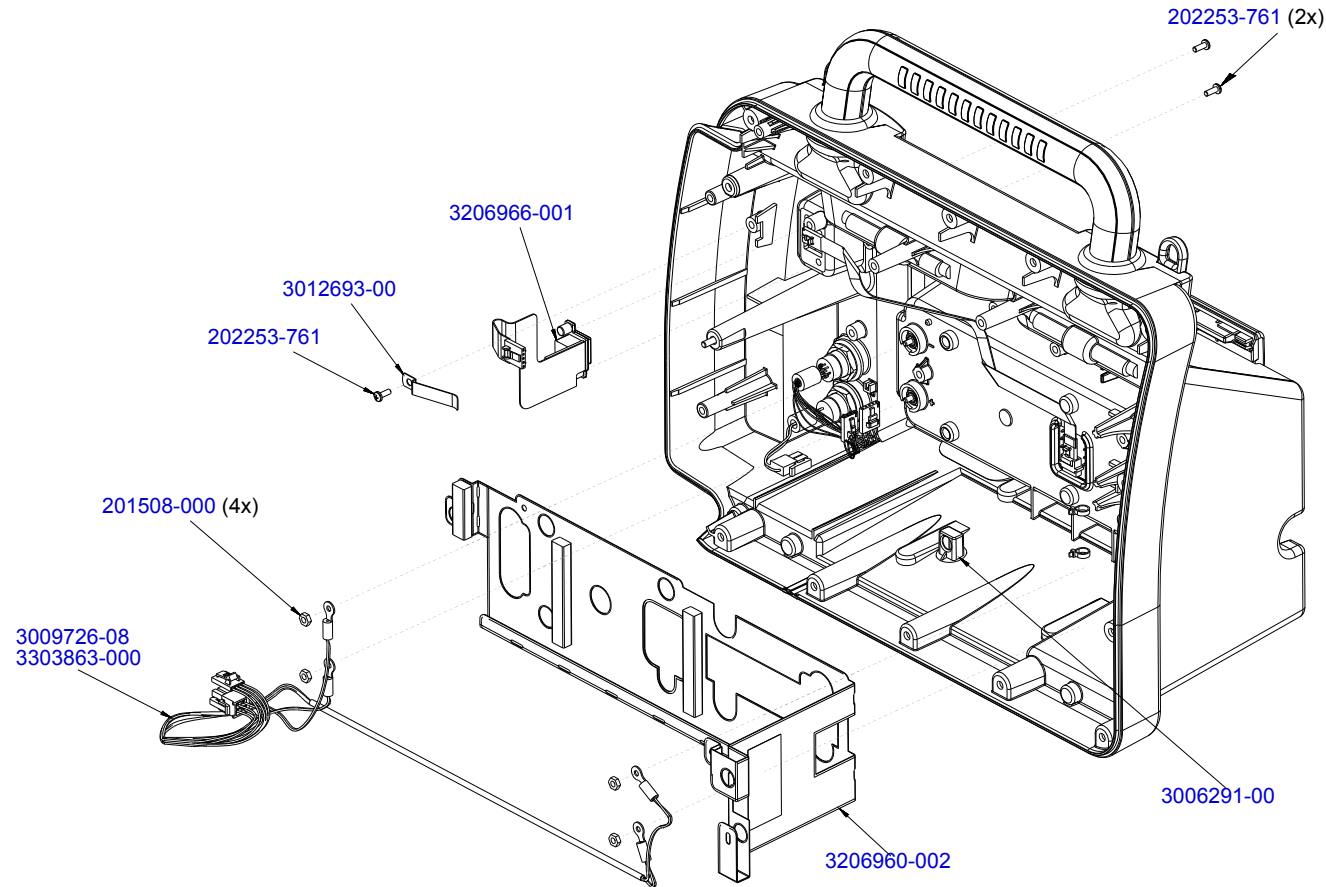

Figure 11.16—Rear Case view 3 of 7

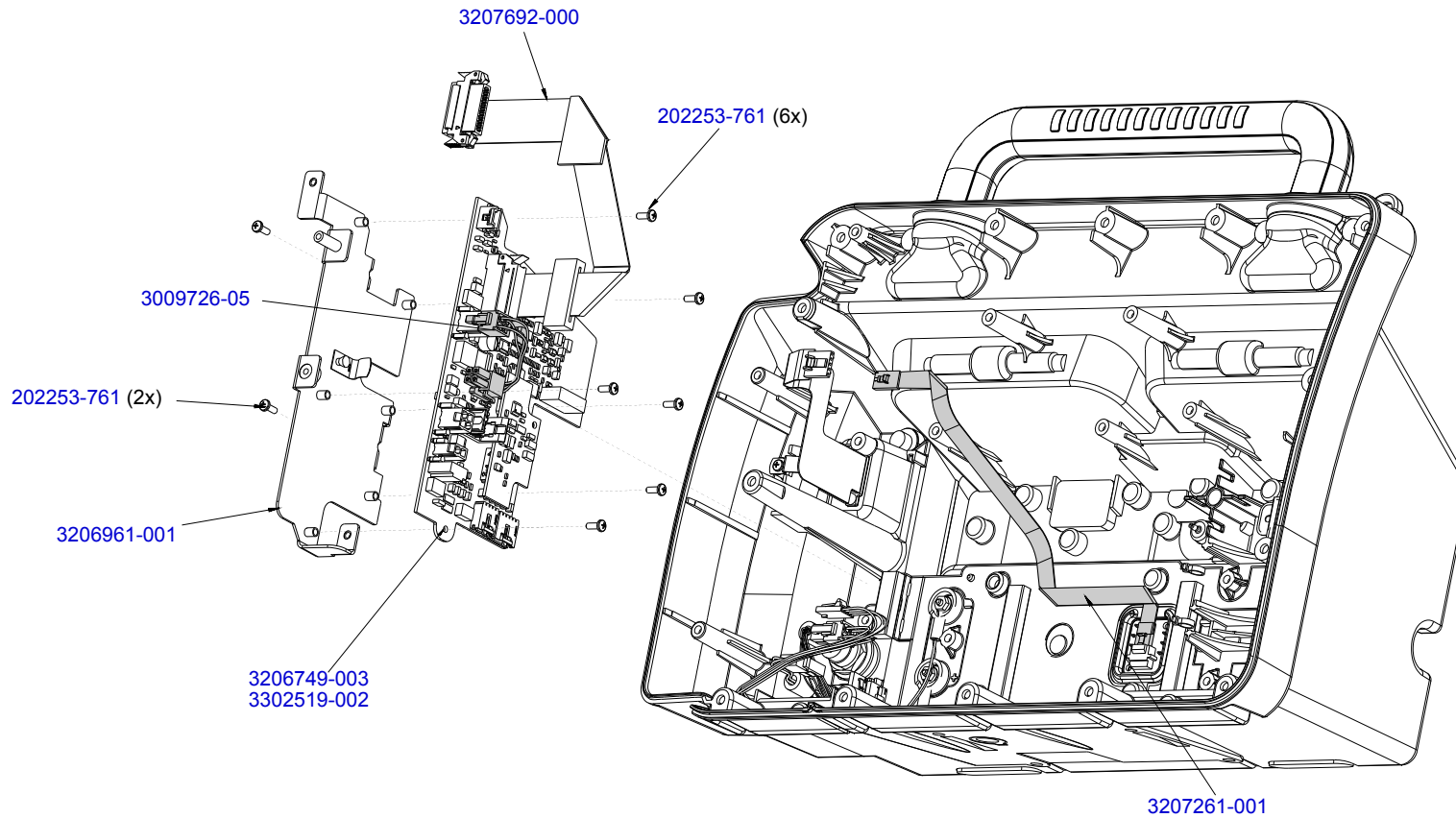

Figure 11.17—Rear Case view 4 of 7

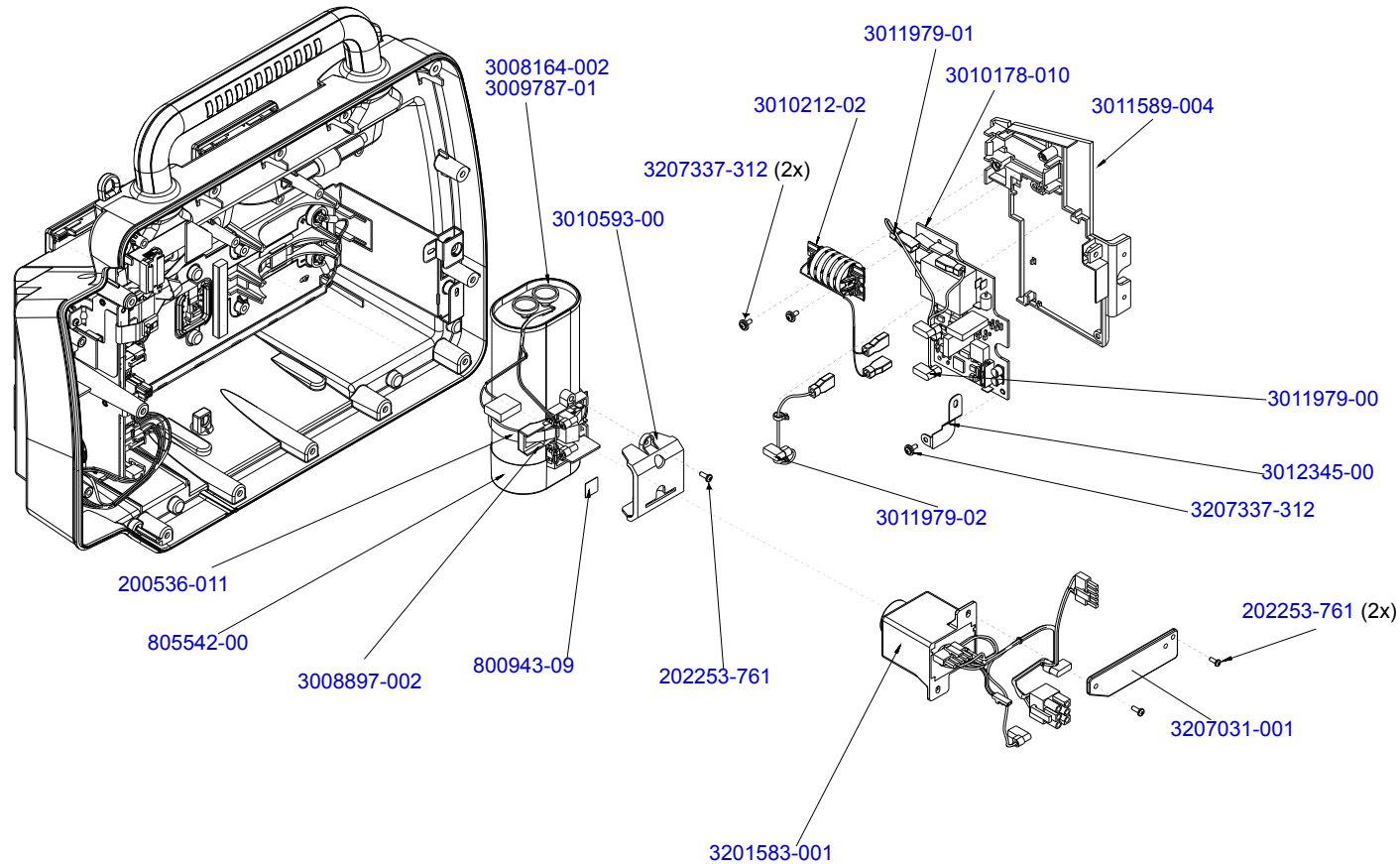

Figure 11.18—Rear Case view 5 of 7



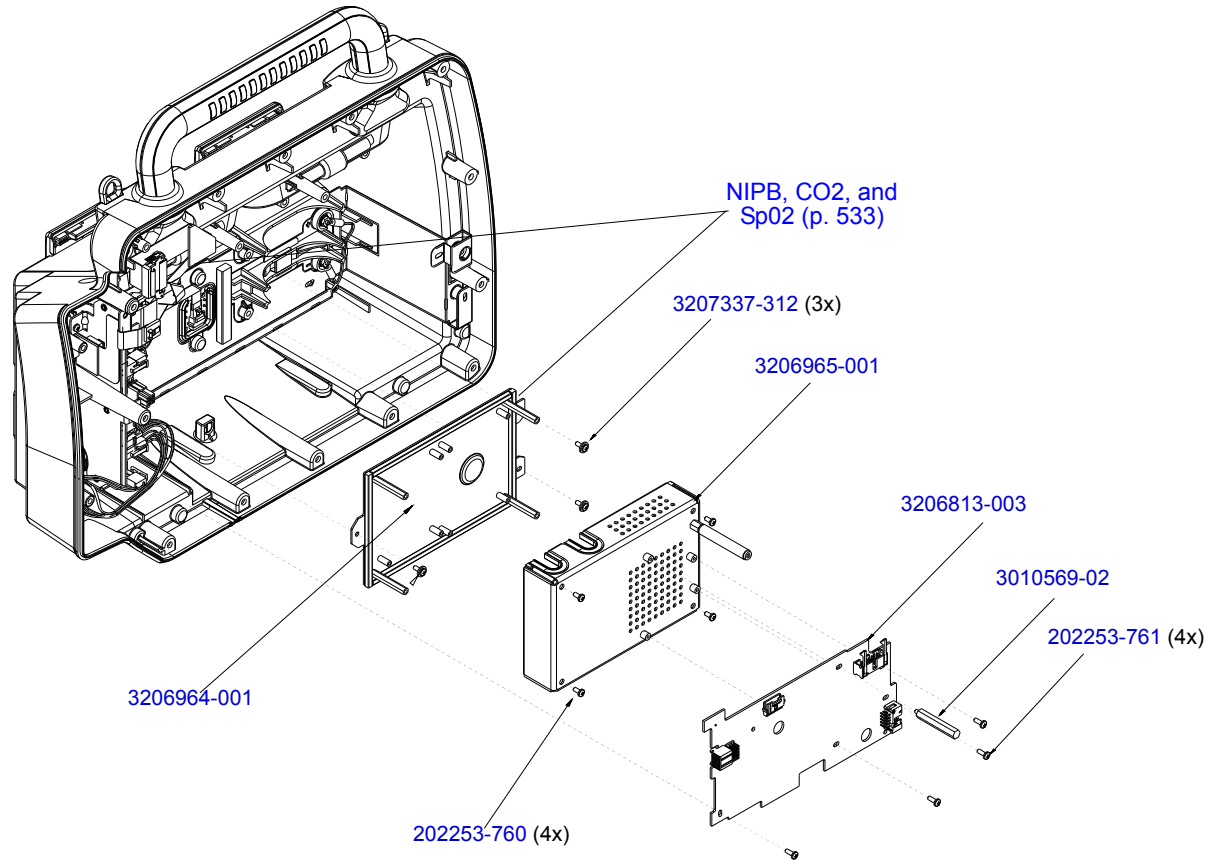

Figure 11.19—Rear Case view 6 of 7

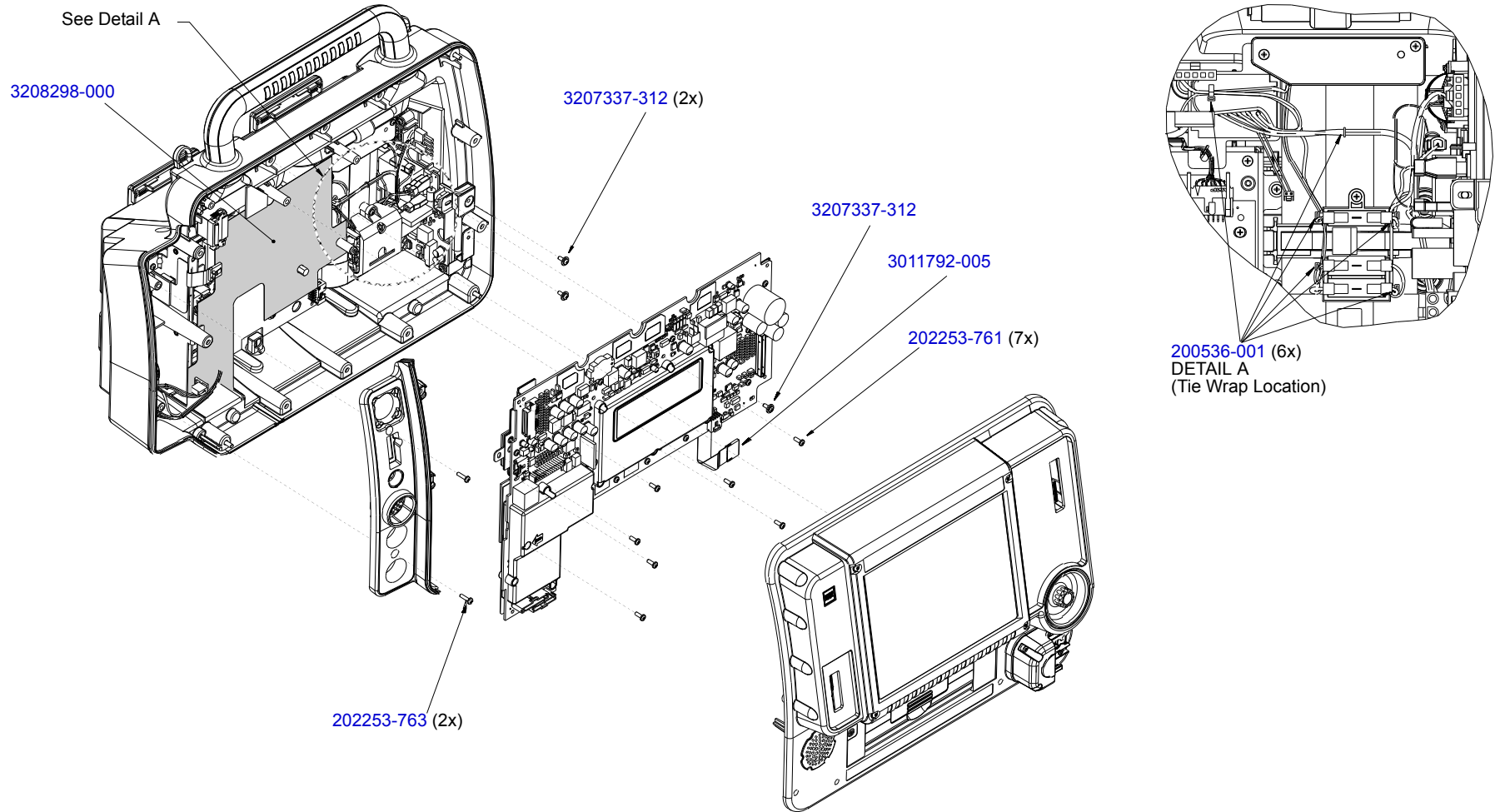

Figure 11.20—Rear Case view 7 of 7

### Rear Parts List

Table 11.7—Rear Parts

MIN	CAT.	Qty.	Description	Notes
3206749-003 3302519-002	21330-001404 21330-001408	1	A03 - PCB ASSY - POWER (V1) A03 - PCB ASSY - POWER (V2 Auxiliary Power)	Refer to <a href="#">Figure 11.17: Rear Case view 4 of 7, p. 523.</a> See also <a href="#">Figure 11.23 (p. 564)</a> for connection diagram.
3206813-003 3306308-000	21330-001285 21330-001483	1	A06 - PCB ASSY - OEM A06 - OEM PCB (V2 Auxiliary Power)	Refer to <a href="#">Figure 11.18: Rear Case view 5 of 7, p. 524.</a> See also <a href="#">Figure 11.26 (p. 567)</a> for connection diagram.
3207037-002	21330-001288	1	A07 - CONTACT ASSY-BATTERY	Refer to <a href="#">Figure 11.14: Rear Case view 1 of 7, p. 520.</a> See also <a href="#">Figure 11.27 (p. 568)</a> for connection diagram.
3201583-001	21330-000920	1	A13 - RELAY ASSEMBLY - ISOLATION, DPDT, BTE	Refer to <a href="#">Figure 11.18: Rear Case view 5 of 7, p. 524.</a> See also <a href="#">Figure 11.33 (p. 574)</a> for connection diagram.
3010212-02	21300-001392	1	A14 - INDUCTIVE RESISTOR-5 OHM	Refer to <a href="#">Figure 11.18: Rear Case view 5 of 7, p. 524.</a> See also <a href="#">Figure 11.34 (p. 575)</a> for connection diagram.
3008164-002	21300-001320	1	A15 - CAPACITOR-ENERGY STORAGE,BTE	Refer to <a href="#">Figure 11.18: Rear Case view 5 of 7, p. 524.</a> See also <a href="#">Figure 11.35 on p. 576.</a>
3008897-002	21300-001337	1	A17 - BRACKET-INTERCONNECT	Refer to <a href="#">Figure 11.18: Rear Case view 5 of 7, p. 524.</a> See also <a href="#">Figure 11.37 on p. 578.</a>

**Table 11.7—Rear Parts (Continued)**

MIN	CAT.	Qty.	Description	Notes
3010178-010	21330-000176	1	A22 - PCB ASSY - BIPHASIC MODULE, CEDAR (BTE)	Refer to <a href="#">Figure 11.18: Rear Case view 5 of 7</a> , p. 524. See also <a href="#">Figure 11.39 (p. 580)</a> for connections diagram.
3207726-000	21330-001272	1	ASSEMBLY - ENCLOSURE, REAR	Refer to <a href="#">Figure 11.16: Rear Case view 3 of 7</a> , p. 522.
3207881-000	21330-001276	1	ASSEMBLY - RETAINER, BATTERY	Refer to <a href="#">Figure 11.14: Rear Case view 1 of 7</a> , p. 520.
3207031-001	21300-007317	1	BRACKET - CAPACITOR	Refer to <a href="#">Figure 11.18: Rear Case view 5 of 7</a> , p. 524.
3206965-001	21330-001195	1	BRACKET - COVER, OEM MODULES	Refer to <a href="#">Figure 11.18: Rear Case view 5 of 7</a> , p. 524.
3206964-001	21330-001194	1	BRACKET - MOUNTING, OEM MODULES	Refer to <a href="#">Figure 11.18: Rear Case view 5 of 7</a> , p. 524.
3206961-001	21330-001257	1	BRACKET ASSY - POWER PCB	Refer to <a href="#">Figure 11.17: Rear Case view 4 of 7</a> , p. 523.
3011589-004	21300-007546	1	BRACKET - MOUNTING, BTE PCB	Refer to <a href="#">Figure 11.18: Rear Case view 5 of 7</a> , p. 524.
3207708-000	21300-007472	2	BRACKET - SHOULDER STRAP	Refer to <a href="#">Figure 11.15: Rear Case view 2 of 7</a> , p. 521.
3011792-005	21300-001528	1	W20 - CABLE ASSY-FLEX, BTE PCB, THERAPY PCB	Refer to <a href="#">Figure 11.18: Rear Case view 5 of 7</a> , p. 524. See also <a href="#">Figure 11.60 (p. 601)</a> for connections diagram.
802278-02	21300-002023	4	CONN-PLUG, BANANA PIN	Refer to <a href="#">Figure 11.14: Rear Case view 1 of 7</a> , p. 520.
3006766-003	21330-001241	2	COVER - LATCH, PADDLE, GRAY (Part of Rear Case Assembly)	Refer to <a href="#">Figure 11.14: Rear Case view 1 of 7</a> , p. 520. Repair kit, <a href="#">Paddle Retainer Repair Kit (MIN 3305431-017)</a> (p. 625).
3207746-000	21300-007470	1	COVER PLATE - HANDLE, RIGHT	Refer to <a href="#">Figure 11.15: Rear Case view 2 of 7</a> , p. 521.

**Table 11.7—Rear Parts (Continued)**

MIN	CAT.	Qty.	Description	Notes
3207707-000	21300-007469	1	COVER PLATE - HANDLE, LEFT	Refer to <a href="#">Figure 11.15: Rear Case view 2 of 7, p. 521.</a>
3206960-002	21330-001190	1	GROUND PLANE - FLEXIBLE REAR CASE	Refer to <a href="#">Figure 11.16: Rear Case view 3 of 7, p. 522.</a>
3207706-000	21300-007471	1	HANDLE	Refer to <a href="#">Figure 11.15: Rear Case view 2 of 7, p. 521.</a>
800943-09	21501-000248	1	LABEL - SYMBOL,INT'L	Refer to <a href="#">Figure 11.18: Rear Case view 5 of 7, p. 524.</a>
806091-00	21300-002691	2	NUT - AUX, SYSTEM, CONN, STAINLESS STEEL	Refer to <a href="#">Figure 11.14: Rear Case view 1 of 7, p. 520.</a>
201508-000	21300-000804	4	NUT - LOCK, CARBON STEEL, KEP, #4-40 THREAD	Refer to <a href="#">Figure 11.16: Rear Case view 3 of 7, p. 522.</a>
805487-00	21300-002650	2	PLATE - SEAL, CONNECTOR, REAR	Refer to <a href="#">Figure 11.14: Rear Case view 1 of 7, p. 520.</a>
200536-011	21300-000504	1	RETNR - CABLE TIE, NYLON, .35W X 21.0 L	Refer to <a href="#">Figure 11.18: Rear Case view 5 of 7, p. 524.</a>
200536-001	21300-000499	6	RETNR - CABLE TIE, NYLON, .10 W X 4.0 L	Refer to <a href="#">Figure 11.20: Rear Case view 7 of 7, p. 526.</a>
202253-761	21300-001038	25	SCREW-M,CS,Z,PH, NYLOCK, 4-40 X .312L	Refer to <a href="#">Figure 11.16: Rear Case view 3 of 7, p. 522</a> , <a href="#">Figure 11.17: Rear Case view 4 of 7, p. 523</a> , and <a href="#">Figure 11.18: Rear Case view 5 of 7, p. 524.</a>
202253-760	21300-006251	4	SCREW-M, PH, NYLOK, CS, 4-40, .250L	Refer to <a href="#">Figure 11.18: Rear Case view 5 of 7, p. 524.</a>
3207337-312	21300-007297	8	SCREW-MACH, PNH, PHH, NYLOCK, 4-40, 0.312L, WSHR, CS, ZN	Refer to <a href="#">Figure 11.18: Rear Case view 5 of 7, p. 524.</a>
201407-069	21300-000777	14	SCREW, SELF-SEAL, SELF-LOCK, 6-32 X 0.375	Refer to <a href="#">Figure 11.14: Rear Case view 1 of 7, p. 520</a> and <a href="#">Figure 11.15: Rear Case view 2 of 7, p. 521.</a>

**Table 11.7—Rear Parts (Continued)**

MIN	CAT.	Qty.	Description	Notes
202253-763	21300-006965	2	SCREW, MACHINE, PANHEAD, NYLOK, 4-40 X 0.437	Refer to <a href="#">Figure 11.20: Rear Case view 7 of 7</a> , p. 526.
200060-011	21300-000203	2	SEAL, O-RING,RUBBER, .551ID	Refer to <a href="#">Figure 11.14: Rear Case view 1 of 7</a> , p. 520.
3006291-00	21300-001284	1	SEAL, DRAIN	Refer to <a href="#">Figure 11.16: Rear Case view 3 of 7</a> , p. 522.
3009787-01	21300-001377	1	SHIELD - DIELECTRIC,CAPACITOR	Refer to <a href="#">Figure 11.18: Rear Case view 5 of 7</a> , p. 524.
3208298-000	21300-007744	1	SHIELD - DIELECTRIC, OEM, POWER	
805542-00	21300-002660	1	SHIELD - END,CAPACITOR	Refer to <a href="#">Figure 11.18: Rear Case view 5 of 7</a> , p. 524.
3010593-00	21300-001407	1	SHIELD - HIGH VOLTAGE	Refer to <a href="#">Figure 11.18: Rear Case view 5 of 7</a> , p. 524.
3012693-00	21300-001575	1	SPRING, CLAMP, STAINLES SSTEEL	Refer to <a href="#">Figure 11.16: Rear Case view 3 of 7</a> , p. 522.
3010569-02	21300-001402	1	STANDOFF, HEX, NYLON	Refer to <a href="#">Figure 11.18: Rear Case view 5 of 7</a> , p. 524.
3012345-00	21300-001567	1	STRAP - GROUND, BTE PCB	Refer to <a href="#">Figure 11.18: Rear Case view 5 of 7</a> , p. 524.
3207692-000	21300-007456	1	W01 - CABLE ASSY - POWER, SYSTEM, PCBA	Refer to <a href="#">Figure 11.17: Rear Case view 4 of 7</a> , p. 523. See also <a href="#">Figure 11.41</a> on p. 582 for connection information.
3009726-05	21300-001373	1	W02 - WIRE HARNESS-POWER/THERAPY/PCB	Refer to <a href="#">Figure 11.17: Rear Case view 4 of 7</a> , p. 523.
3207261-001	21330-001316	1	W05 - CABLE ASSEMBLY-CONTACT PCB/POWER PCB	Refer to <a href="#">Figure 11.17: Rear Case view 4 of 7</a> , p. 523. See also <a href="#">Figure 11.45</a> (p. 586) for connection diagram.

**Table 11.7—Rear Parts (Continued)**

MIN	CAT.	Qty.	Description	Notes
3009652-01	21330-000156	1	W08 - CABLE ASSY-SYSTEM	Refer to <a href="#">Figure 11.14: Rear Case view 1 of 7, p. 520.</a>
3303848-002	21330-001485	1	W09 - CABLE ASSY - AUX PWR (V2 Auxiliary Power)	Refer to <a href="#">Figure 11.14: Rear Case view 1 of 7, p. 520.</a>
3009726-08 3303863-000	21300-001374 21330-001394	1	W10 - WIRE HARNESS, BATTERY POWER W10 - BATTERY POWER (V2 Auxiliary Power)	Refer to <a href="#">Figure 11.16: Rear Case view 3 of 7, p. 522.</a>
3206966-001	21330-001196	1	W14 - FLEX ASSY - USB	Refer to <a href="#">Figure 11.16: Rear Case view 3 of 7, p. 522.</a>
3011979-00	21300-001541	1	WIRE HARNESS-BTE, J103 - PIN 9	Refer to <a href="#">Figure 11.18: Rear Case view 5 of 7, p. 524.</a>
3011979-01	21300-001542	1	WIRE HARNESS-BTE, J101 - PIN 3	Refer to <a href="#">Figure 11.18: Rear Case view 5 of 7, p. 524.</a>
3011979-02	21300-001543	1	WIRE HARNESS-BTE, J105 TO PIN 6	Refer to <a href="#">Figure 11.18: Rear Case view 5 of 7, p. 524.</a>

### OEM Optional Assemblies, Diagrams and Parts Lists

- [NIPB, CO2, and SpO2 \(p. 533\)](#)
- [SpO2 Internal Parts List \(p. 534\)](#)
- [NIBP Parts List \(p. 534\)](#)
- [CO2 Parts List \(p. 535\)](#)



### NIPB, CO2, and SpO2

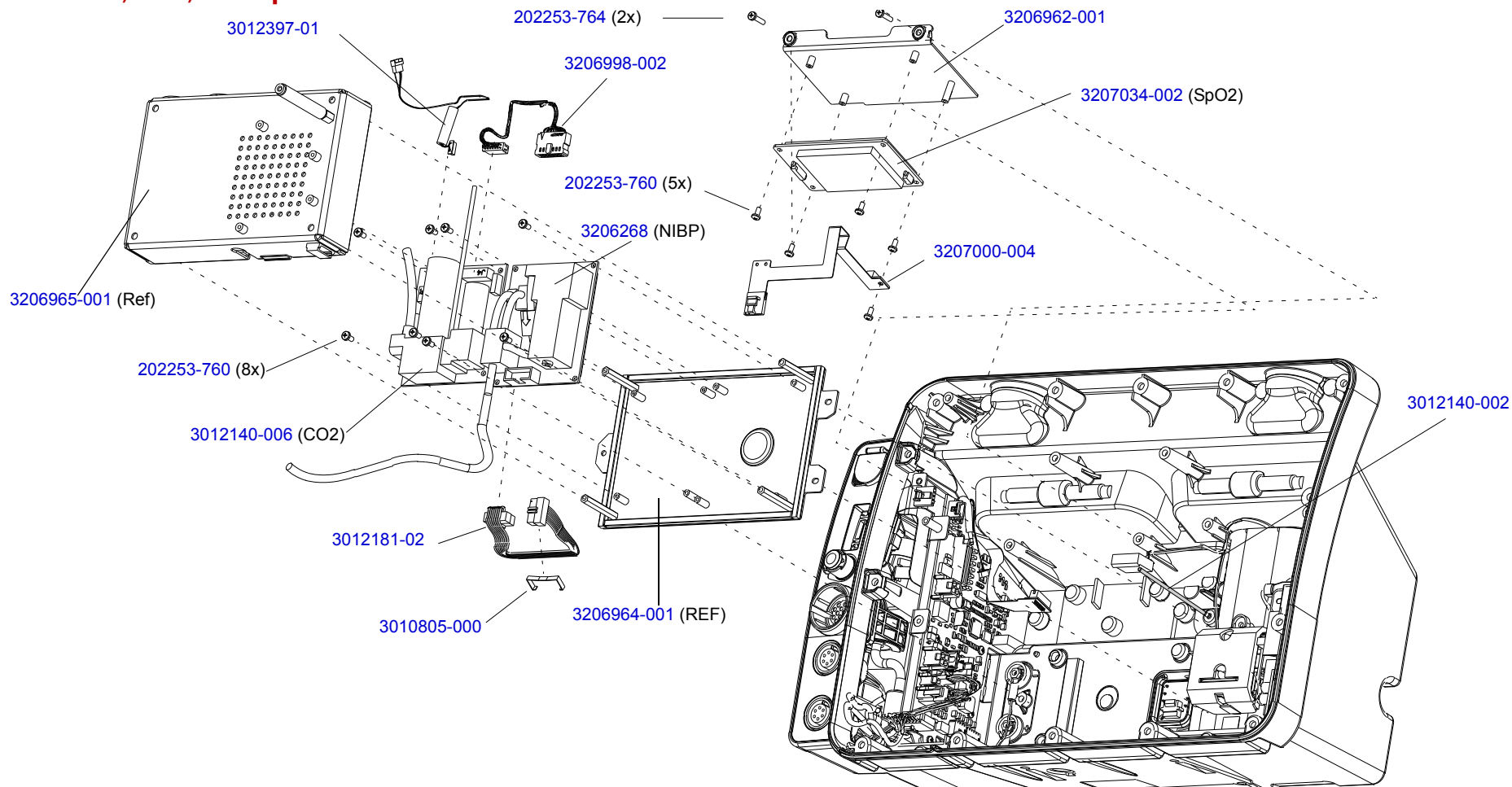

Figure 11.21—NIPB, CO2, and SpO2 view 1 of 1

### SpO2 Internal Parts List

See [Figure 11.21: NIPB, CO2, and SpO2 view 1 of 1](#), p. 533 for the parts listed in this table.

**Table 11.8—SpO2 Part Numbers**

MIN	CAT.	Qty	Description	Notes
202253-760	21300-006251	5	SCREW-M, PH, NYLOK, CS, 4-40, .250L	
202253-764	21300-004599	2	SCREW, MACHINE, PANHEAD, NYLOK, 4-40 X .500	
3206962-001	21300-007550	1	BRACKET - MOUNTING, SpO2 MODULE	
3207000-004	21330-001321	1	W21 - ASSY-CABLE, FLEX, SpO2, OEM, PCB	
3207034-002	21300-007710	1	A16 - MODULE-OEM, PULSE OXIMETER, MX-1	

### NIBP Parts List

See [Figure 11.11: Parameter Bezel view 2 of 4 \(optional CO2 and NIBP\)](#), p. 513 for NIBP external connector parts.

**Table 11.9—NIBP Part Numbers**

MIN	CAT.	Qty	Description	Notes
202253-760	21300-006251	4	SCREW-M, PH, NYLOK, CS, 4-40, .250L	Refer to <a href="#">NIPB, CO2, and SpO2 (p. 533)</a>
3010805-000	21300-001416	1	SOCKET RETAINER CLIP -10PIN	Refer to <a href="#">NIPB, CO2, and SpO2 (p. 533)</a>

**Table 11.9—NIBP Part Numbers**

MIN	CAT.	Qty	Description	Notes
3012181-02	21330-000235	1	W27 - CABLE ASSY-RIBBON, NIBP/OEM PCB	Refer to <a href="#">NIPB, CO2, and SpO2 (p. 533)</a> . For cable interconnect view, see <a href="#">Figure 11.64 (p. 605)</a> .
3206268	21300-007912	1	A21 - NIBP ND+ MODULE, DSP V4.0 AND SAFETY CPU V2.0	Refer to <a href="#">NIPB, CO2, and SpO2 (p. 533)</a> . For cable interconnect view, see <a href="#">Figure 11.38 (p. 579)</a> . Repair kit, <a href="#">Paddle Retainer Repair Kit (MIN 3305431-017) (p. 625)</a> .

### CO2 Parts List

See [Figure 11.11: Parameter Bezel view 2 of 4 \(optional CO2 and NIBP\), p. 513](#) for CO2 external connector parts.

**Table 11.10—CO2 Part Numbers**

MIN	CAT.	Qty	Description	Notes
202253-760	21300-006251	4	SCREW-M, PH, NYLOK, CS, 4-40, .250L	Refer to <a href="#">NIPB, CO2, and SpO2 (p. 533)</a> .
3012140-002	21300-001557	1	EXHAUST TUBING - CO2	Refer to <a href="#">NIPB, CO2, and SpO2 (p. 533)</a> .
3012140-006	21300-006948	1	A23 - MODULE, CO2, MINI	Refer to <a href="#">NIPB, CO2, and SpO2 (p. 533)</a> . For cable interconnect view, see <a href="#">Figure 11.40 (p. 581)</a> .

Table 11.10—CO2 Part Numbers

MIN	CAT.	Qty	Description	Notes
3012397-01	21330-000237	1	W30 - CABLE ASSY-CO2, ADAPTER	Refer to <a href="#">NIPB</a> , <a href="#">CO2</a> , and <a href="#">SpO2</a> (p. 533). For cable interconnect view, see <a href="#">Figure 11.66</a> (p. 607).
3206998-002	21330-001217	1	W26 - CABLE ASSY-CO2 MODULE, OEM PCB	Refer to <a href="#">NIPB</a> , <a href="#">CO2</a> , and <a href="#">SpO2</a> (p. 533). For cable interconnect view, see <a href="#">Figure 11.63</a> (p. 604). Repair kit, <a href="#">CO2 Module Repair Kit (MIN 3305431-002)</a> (p. 614).

### Label Language Parts

Label language parts include:

- [A09- Printer Control Keypad - Languages \(p. 538\)](#)
- [A10 Main Keypad - Languages \(V1\) \(p. 540\)](#)
- [A10 Main Keypad - Languages \(V2\) \(p. 542\)](#)
- [LIFEPAK 15 Label Set - Languages \(V1\) \(p. 544\)](#)
- [LIFEPAK 15 Label Set - Languages \(V2\) \(p. 551\)](#)

### A09- Printer Control Keypad - Languages

Table 11.11— A09 Keypad language parts

MIN	CAT.	Qty	Part Description
3207080-000	21330-001238	1	Keypad Assy - Printer Control, 12-Lead, English
3207080-001	21330-001264	1	Keypad Assy - Printer Control, English
3207080-040	21330-001326	1	Keypad Assy - Printer Control, 12-Lead, German
3207080-041	21330-001327	1	Keypad Assy - Printer Control, German
3207080-080	21330-001330	1	Keypad Assy - Printer Control, 12-Lead, French
3207080-081	21330-001331	1	Keypad Assy - Printer Control, French
3207080-120	21330-001334	1	Keypad Assy - Printer Control, 12-Lead, Spanish
3207080-121	21330-001335	1	Keypad Assy - Printer Control, Spanish
3207080-060	21330-001328	1	Keypad Assy - Printer Control, 12-Lead, Italian
3207080-061	21330-001329	1	Keypad Assy - Printer Control, Italian
3207080-140	21330-001383	1	Keypad Assy - Printer Control, 12-Lead, Portuguese
3207080-141	21330-001395	1	Keypad Assy - Printer Control, Portuguese
3207080-180	21330-001336	1	Keypad Assy - Printer Control, 12-Lead, Swedish
3207080-181	21330-001337	1	Keypad Assy - Printer Control, Swedish
3207080-200	21330-001338	1	Keypad Assy - Printer Control, 12-Lead, Danish
3207080-201	21330-001339	1	Keypad Assy - Printer Control, Danish

A09



**Table 11.11— A09 Keypad language parts (Continued)**

3207080-220	21330-001384	1	Keypad Assy - Printer Control, 12-Lead, Finnish
3207080-221	21330-001402	1	Keypad Assy - Printer Control, Finnish
3207080-240	21330-001340	1	Keypad Assy - Printer Control, 12-Lead, Norwegian
3207080-241	21330-001341	1	Keypad Assy - Printer Control, Norwegian
3207080-100	21330-001332	1	Keypad Assy - Printer Control, 12-Lead, Dutch
3207080-101	21330-001333	1	Keypad Assy - Printer Control, Dutch
3207080-260	21330-001342	1	Keypad Assy - Printer Control, 12-Lead, Polish
3207080-261	21330-001343	1	Keypad Assy - Printer Control, Polish
3207080-280	21330-001385	1	Keypad Assy - Printer Control, 12-Lead, Hungarian
3207080-281	21330-001398	1	Keypad Assy - Printer Control, Hungarian
3207080-300	21330-001386	1	Keypad Assy - Printer Control, 12-Lead, Czech
3207080-301	21330-001401	1	Keypad Assy - Printer Control, Czech

### A10 Main Keypad - Languages (V1)

Table 11.12— A10 Keypad language parts (V1)

MIN	CAT.	Qty	Part Description
3207079-001	21330-001252	1	Keypad Assy (V1) - Main Cntrl, CPR, NIBP, English
3207079-002	21330-001261	1	Keypad Assy (V1) - Main Cntrl, CPR, English
3207079-040	21330-001298	1	Keypad Assy (V1) - Main Cntrl, CPR, NIBP, German
3207079-041	21330-001299	1	Keypad Assy (V1)- Main Cntrl, CPR, German
3207079-060	21330-001300	1	Keypad Assy (V1) - Main Cntrl, CPR, NIBP, Italian
3207079-061	21330-001301	1	Keypad Assy (V1) - Main Cntrl, CPR, Italian
3207079-080	21330-001302	1	Keypad Assy (V1) - Main Cntrl, CPR, NIBP, French
3207079-081	21330-001303	1	Keypad Assy (V1) - Main Cntrl, CPR, French
3207079-100	21330-001304	1	Keypad Assy (V1) - Main Cntrl, CPR, NIBP, Dutch
3207079-101	21330-001305	1	Keypad Assy (V1) - Main Cntrl, CPR, Dutch
3207079-120	21330-001306	1	Keypad Assy (V1) - Main Cntrl, CPR, NIBP, Spanish
3207079-121	21330-001307	1	Keypad Assy (V1) - Main Cntrl, CPR, Spanish
3207079-140	21330-001387	1	Keypad Assy (V1) - Main Cntrl, CPR, NIBP, Portuguese
3207079-141	21330-001400	1	Keypad Assy (V1) - Main Cntrl, CPR, Portuguese
3207079-180	21330-001308	1	Keypad Assy (V1) - Main Cntrl, CPR, NIBP, Swedish
3207079-181	21330-001309	1	Keypad Assy (V1) - Main Cntrl, CPR, Swedish





**Table 11.12— A10 Keypad language parts (V1)**

3207079-200	21330-001310	1	Keypad Assy (V1) - Main Cntrl, CPR, NIBP, Danish
3207079-201	21330-001311	1	Keypad Assy (V1) - Main Cntrl, CPR, Danish
3207079-220	21330-001388	1	Keypad Assy (V1) - Main Cntrl, CPR, NIBP, Finnish
3207079-221	21330-001399	1	Keypad Assy (V1) - Main Cntrl, CPR, Finnish
3207079-240	21330-001312	1	Keypad Assy (V1) - Main Cntrl, CPR, NIBP, Norwegian
3207079-241	21330-001313	1	Keypad Assy (V1) - Main Cntrl, CPR, Norwegian
3207079-260	21330-001314	1	Keypad Assy (V1) - Main Cntrl, CPR, NIBP, Polish
3207079-261	21330-001315	1	Keypad Assy (V1) - Main Cntrl, CPR, Polish
3207079-280	21330-001389	1	Keypad Assy (V1) - Main Cntrl, CPR, NIBP, Hungarian
3207079-281	21330-001397	1	Keypad Assy (V1) - Main Cntrl, CPR, Hungarian
3207079-300	21330-001390	1	Keypad Assy (V1) - Main Cntrl, CPR, NIBP, Czech
3207079-301	21330-001396	1	Keypad Assy (V1) - Main Cntrl, CPR, Czech

### A10 Main Keypad - Languages (V2)

Table 11.13— A10 Keypad language parts (V2)

MIN	CAT.	Qty	Part Description
3302470-002		1	Keypad Assy (V2) - Main Cntrl, CPR, NIBP, English
3302470-003		1	Keypad Assy (V2) - Main Cntrl, CPR, English
3302470-042		1	Keypad Assy (V2) - Main Cntrl, CPR, NIBP, German
3302470-043		1	Keypad Assy (V2) - Main Cntrl, CPR, German
3302470-062		1	Keypad Assy (V2) - Main Cntrl, CPR, NIBP, Italian
3302470-063		1	Keypad Assy (V2) - Main Cntrl, CPR, Italian
3302470-082		1	Keypad Assy (V2) - Main Cntrl, CPR, NIBP, French
3302470-083		1	Keypad Assy (V2) - Main Cntrl, CPR, French
3302470-102		1	Keypad Assy (V2) - Main Cntrl, CPR, NIBP, Dutch
3302470-103		1	Keypad Assy (V2) - Main Cntrl, CPR, Dutch
3302470-122		1	Keypad Assy (V2) - Main Cntrl, CPR, NIBP, Spanish
3302470-123		1	Keypad Assy (V2) - Main Cntrl, CPR, Spanish
3302470-142		1	Keypad Assy (V2) - Main Cntrl, CPR, NIBP, Portuguese
3302470-143		1	Keypad Assy (V2) - Main Cntrl, CPR, Portuguese
3302470-162		1	Keypad Assy (V2) - Main Cntrl, CPR, NIBP, Brazilian
3302470-163		1	Keypad Assy (V2) - Main Cntrl, CPR, Brazilian

3302470-XXX

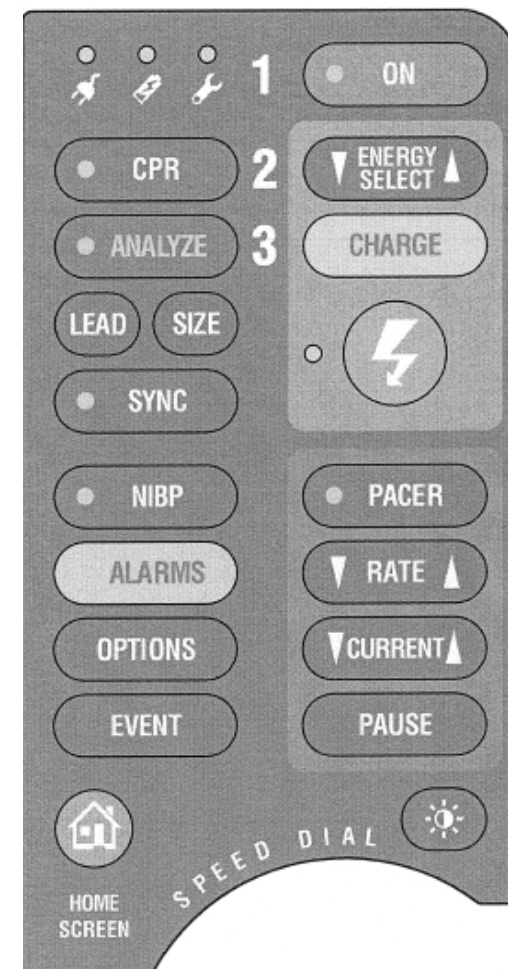

**Table 11.13— A10 Keypad language parts (V2)**

3302470-182	1	Keypad Assy (V2) - Main Cntrl, CPR, NIBP, Swedish
3302470-183	1	Keypad Assy (V2) - Main Cntrl, CPR, Swedish
3302470-202	1	Keypad Assy (V2) - Main Cntrl, CPR, NIBP, Danish
3302470-203	1	Keypad Assy (V2) - Main Cntrl, CPR, Danish
3302470-222	1	Keypad Assy (V2) - Main Cntrl, CPR, NIBP, Finnish
3302470-223	1	Keypad Assy (V2) - Main Cntrl, CPR, Finnish
3302470-242	1	Keypad Assy (V2) - Main Cntrl, CPR, NIBP, Norwegian
3302470-243	1	Keypad Assy (V2) - Main Cntrl, CPR, Norwegian
3302470-262	1	Keypad Assy (V2) - Main Cntrl, CPR, NIBP, Polish
3302470-263	1	Keypad Assy (V2) - Main Cntrl, CPR, Polish
3302470-282	1	Keypad Assy (V2) - Main Cntrl, CPR, NIBP, Hungarian
3302470-283	1	Keypad Assy (V2) - Main Cntrl, CPR, Hungarian
3302470-302	1	Keypad Assy (V2) - Main Cntrl, CPR, NIBP, Czech
3302470-303	1	Keypad Assy (V2) - Main Cntrl, CPR, Czech
3302470-322	1	Keypad Assy (V2) - Main Cntrl, CPR, NIBP, Russian
3302470-323	1	Keypad Assy (V2) - Main Cntrl, CPR, Russian
3302470-382	1	Keypad Assy (V2) - Main Cntrl, CPR, NIBP, Korean
3302470-383	1	Keypad Assy (V2) - Main Cntrl, CPR, Korean

### LIFEPAK 15 Label Set - Languages (V1)

Table 11.14—Label Set Part Numbers (V1)

MIN	CAT.	Qty	Part Description
3207318-013	21501-002039	1	Label Set (V1) – ECG, English
3207318-014	21501-002040	1	Label Set (V1) – ECG, SpO2, English
3207318-015	21501-002041	1	Label Set (V1) – ECG, SpO2, CO2, English
3207318-016	21501-002042	1	Label Set (V1) – ECG, SpO2, NIBP, IP, English
3207318-017	21501-002043	1	Label Set (V1) – ECG, SpO2, NIBP, CO2, IP, English
3207318-018	21501-002044	1	Label Set (V1) – ECG, SpO2, NIBP, English
3207318-019	21501-002045	1	Label Set (V1) – ECG, SpO2, NIBP, CO2, English
3207318-040	21501-002050	1	Label Set (V1) – ECG, German
3207318-041	21501-002051	1	Label Set (V1) – ECG, SpO2, German
3207318-042	21501-002052	1	Label Set (V1) – ECG, SpO2, CO2, German
3207318-043	21501-002053	1	Label Set (V1) – ECG, SpO2, NIBP, IP, German
3207318-044	21501-002054	1	Label Set (V1) – ECG, SpO2, NIBP, CO2, IP, German
3207318-045	21501-002055	1	Label Set (V1) – ECG, SpO2, NIBP, German

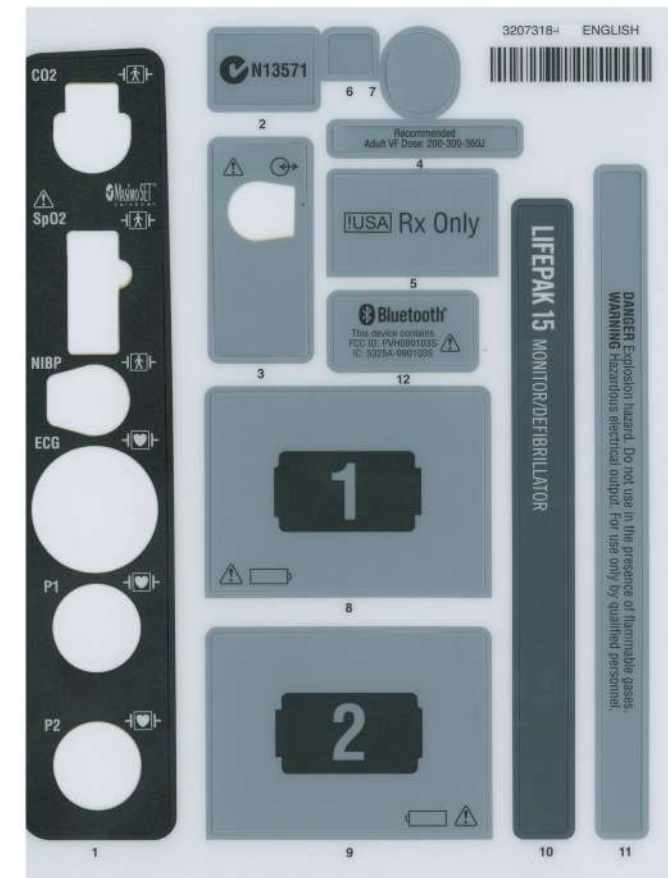

**Table 11.14—Label Set Part Numbers (V1) (Continued)**

MIN	CAT.	Qty	Part Description
3207318-046	21501-002056	1	Label Set (V1) – ECG, SpO2, NIBP, CO2, German
3207318-060	21501-002057	1	Label Set (V1) – ECG, Italian
3207318-061	21501-002058	1	Label Set (V1) – ECG, SpO2, Italian
3207318-062	21501-002059	1	Label Set (V1) – ECG, SpO2, CO2, Italian
3207318-063	21501-002060	1	Label Set (V1) – ECG, SpO2, NIBP, IP, Italian
3207318-064	21501-002061	1	Label Set (V1) – ECG, SpO2, NIBP, CO2, IP, Italian
3207318-065	21501-002062	1	Label Set (V1) – ECG, SpO2, NIBP, Italian
3207318-066	21501-002063	1	Label Set (V1) – ECG, SpO2, NIBP, CO2, Italian
3207318-080	21501-002064	1	Label Set (V1) – ECG, French
3207318-081	21501-002065	1	Label Set (V1) – ECG, SpO2, French
3207318-082	21501-002066	1	Label Set (V1) – ECG, SpO2, CO2, French
3207318-083	21501-002067	1	Label Set (V1) – ECG, SpO2, NIBP, IP, French
3207318-084	21501-002068	1	Label Set (V1) – ECG, SpO2, NIBP, CO2, IP, French
3207318-085	21501-002069	1	Label Set (V1) – ECG, SpO2, NIBP, French
3207318-086	21501-002070	1	Label Set (V1) – ECG, SpO2, NIBP, CO2, French

**Table 11.14—Label Set Part Numbers (V1) (Continued)**

MIN	CAT.	Qty	Part Description
3207318-100	21501-002162	1	Label Set (V1) – ECG, Dutch
3207318-101	21501-002163	1	Label Set (V1) – ECG, SpO2, Dutch
3207318-102	21501-002164	1	Label Set (V1) – ECG, SpO2, CO2, Dutch
3207318-103	21501-002165	1	Label Set (V1) – ECG, SpO2, NIBP, IP, Dutch
3207318-104	21501-002166	1	Label Set (V1) – ECG, SpO2, NIBP, CO2, IP, Dutch
3207318-105	21501-002167	1	Label Set (V1) – ECG, SpO2, NIBP, Dutch
3207318-106	21501-002168	1	Label Set (V1) – ECG, SpO2, NIBP, CO2, Dutch
3207318-120	21501-002169	1	Label Set (V1) – ECG, Spanish
3207318-121	21501-002170	1	Label Set (V1) – ECG, SpO2, Spanish
3207318-122	21501-002171	1	Label Set (V1) – ECG, SpO2, CO2, Spanish
3207318-123	21501-002172	1	Label Set (V1) – ECG, SpO2, NIBP, IP, Spanish
3207318-124	21501-002173	1	Label Set (V1) – ECG, SpO2, NIBP, CO2, IP, Spanish
3207318-125	21501-002174	1	Label Set (V1) – ECG, SpO2, NIBP, Spanish
3207318-126	21501-002175	1	Label Set (V1) – ECG, SpO2, NIBP, CO2, Spanish
3207318-140	21501-002297	1	Label Set (V1) – ECG, Portuguese

**Table 11.14—Label Set Part Numbers (V1) (Continued)**

MIN	CAT.	Qty	Part Description
3207318-141	21501-002298	1	Label Set (V1) – ECG, SpO2, Portuguese
3207318-142	21501-002299	1	Label Set (V1) – ECG, SpO2, CO2, Portuguese
3207318-143	21501-002300	1	Label Set (V1) – ECG, SpO2, NIBP, IP, Portuguese
3207318-144	21501-002301	1	Label Set (V1) – ECG, SpO2, NIBP, CO2, IP, Portuguese
3207318-145	21501-002302	1	Label Set (V1) – ECG, SpO2, NIBP, Portuguese
3207318-146	21501-002303	1	Label Set (V1) – ECG, SpO2, NIBP, CO2, Portuguese
3207318-180	21501-002176	1	Label Set (V1) – ECG, Swedish
3207318-181	21501-002177	1	Label Set (V1) – ECG, SpO2, Swedish
3207318-182	21501-002178	1	Label Set (V1) – ECG, SpO2, CO2, Swedish
3207318-183	21501-002179	1	Label Set (V1) – ECG, SpO2, NIBP, IP, Swedish
3207318-184	21501-002180	1	Label Set (V1) – ECG, SpO2, NIBP, CO2, IP, Swedish
3207318-185	21501-002181	1	Label Set (V1) – ECG, SpO2, NIBP, Swedish
3207318-186	21501-002182	1	Label Set (V1) – ECG, SpO2, NIBP, CO2, Swedish

**Table 11.14—Label Set Part Numbers (V1) (Continued)**

MIN	CAT.	Qty	Part Description
3207318-200	21501-002183	1	Label Set (V1) – ECG, Danish
3207318-201	21501-002184	1	Label Set (V1) – ECG, SpO2, Danish
3207318-202	21501-002185	1	Label Set (V1) – ECG, SpO2, CO2, Danish
3207318-203	21501-002186	1	Label Set (V1) – ECG, SpO2, NIBP, IP, Danish
3207318-204	21501-002187	1	Label Set (V1) – ECG, SpO2, NIBP, CO2, IP, Danish
3207318-205	21501-002188	1	Label Set (V1) – ECG, SpO2, NIBP, Danish
3207318-206	21501-002189	1	Label Set (V1) – ECG, SpO2, NIBP, CO2, Danish
3207318-220	21501-002304	1	Label Set (V1) – ECG, Finnish
3207318-221	21501-002305	1	Label Set (V1) – ECG, SpO2, Finnish
3207318-222	21501-002306	1	Label Set (V1) – ECG, SpO2, CO2, Finnish
3207318-223	21501-002307	1	Label Set (V1) – ECG, SpO2, NIBP, IP, Finnish
3207318-224	21501-002308	1	Label Set (V1) – ECG, SpO2, NIBP, CO2, IP, Finnish
3207318-225	21501-002309	1	Label Set (V1) – ECG, SpO2, NIBP, Finnish
3207318-226	21501-002310	1	Label Set (V1) – ECG, SpO2, NIBP, CO2, Finnish
3207318-240	21501-002190	1	Label Set (V1) – ECG, Norwegian



**Table 11.14—Label Set Part Numbers (V1) (Continued)**

MIN	CAT.	Qty	Part Description
3207318-241	21501-002191	1	Label Set (V1) – ECG, SpO2, Norwegian
3207318-242	21501-002192	1	Label Set (V1) – ECG, SpO2, CO2, Norwegian
3207318-243	21501-002193	1	Label Set (V1) – ECG, SpO2, NIBP, IP, Norwegian
3207318-244	21501-002194	1	Label Set (V1) – ECG, SpO2, NIBP, CO2, IP, Norwegian
3207318-245	21501-002195	1	Label Set (V1) – ECG, SpO2, NIBP, Norwegian
3207318-246	21501-002196	1	Label Set (V1) – ECG, SpO2, NIBP, CO2, Norwegian
3207318-260	21501-002197	1	Label Set (V1) – ECG, Polish
3207318-261	21501-002198	1	Label Set (V1) – ECG, SpO2, Polish
3207318-262	21501-002199	1	Label Set (V1) – ECG, SpO2, CO2, Polish
3207318-263	21501-002200	1	Label Set (V1) – ECG, SpO2, NIBP, IP, Polish
3207318-264	21501-002201	1	Label Set (V1) – ECG, SpO2, NIBP, CO2, IP, Polish
3207318-265	21501-002202	1	Label Set (V1) – ECG, SpO2, NIBP, Polish
3207318-266	21501-002203	1	Label Set (V1) – ECG, SpO2, NIBP, CO2, Polish
3207318-280	21501-002283	1	Label Set (V1) – ECG, Hungarian

**Table 11.14—Label Set Part Numbers (V1) (Continued)**

MIN	CAT.	Qty	Part Description
3207318-281	21501-002284	1	Label Set (V1) – ECG, SpO2, Hungarian
3207318-282	21501-002285	1	Label Set (V1) – ECG, SpO2, CO2, Hungarian
3207318-283	21501-002286	1	Label Set (V1) – ECG, SpO2, NIBP, IP, Hungarian
3207318-284	21501-002287	1	Label Set (V1) – ECG, SpO2, NIBP, CO2, IP, Hungarian
3207318-285	21501-002288	1	Label Set (V1) – ECG, SpO2, NIBP, Hungarian
3207318-286	21501-002289	1	Label Set (V1) – ECG, SpO2, NIBP, CO2, Hungarian
3207318-300	21501-002290	1	Label Set (V1) – ECG, Czech
3207318-301	21501-002291	1	Label Set (V1) – ECG, SpO2, Czech
3207318-302	21501-002292	1	Label Set (V1) – ECG, SpO2, CO2, Czech
3207318-303	21501-002293	1	Label Set (V1) – ECG, SpO2, NIBP, IP, Czech
3207318-304	21501-002294	1	Label Set (V1) – ECG, SpO2, NIBP, CO2, IP, Czech
3207318-305	21501-002295	1	Label Set (V1) – ECG, SpO2, NIBP, Czech
3207318-306	21501-002296	1	Label Set (V1) – ECG, SpO2, NIBP, CO2, Czech

### LIFEPAK 15 Label Set - Languages (V2)

Table 11.15—Label Set Part Numbers (V2)

MIN	CAT.	Qty	Part Description
3305642-000	21501-002408	1	Label Set (V2) – ECG, English
3305642-001	21501-002409	1	Label Set (V2) – ECG, SpO2, English
3305642-002	21501-002410	1	Label Set (V2) – ECG, NIBP, SpO2, English
3305642-003	21501-002411	1	Label Set (V2) – ECG, SpO2, CO2, English
3305642-004	21501-002412	1	Label Set (V2) – ECG, SpO2, NIBP, CO2, English
3305642-005	21501-002413	1	Label Set (V2) – ECG, SpO2, NIBP, IP, English
3305642-006	21501-002414	1	Label Set (V2) – ECG, SpO2, NIBP, CO2, IP, English
3305642-007	21501-002415	1	Label Set (V2) – ECG, SpO2, NIBP, CO2, Temp, English
3305642-040	21501-002475	1	Label Set (V2) – ECG, German
3305642-041	21501-002476	1	Label Set (V2) – ECG, SpO2, German
3305642-042	21501-002477	1	Label Set (V2) – ECG, NIBP, SpO2, German
3305642-043	21501-002478	1	Label Set (V2) – ECG, SpO2, CO2, German
3305642-044	21501-002479	1	Label Set (V2) – ECG, SpO2, NIBP, CO2, German

**Table 11.15—Label Set Part Numbers (V2) (Continued)**

MIN	CAT.	Qty	Part Description
3305642-045	21501-002545	1	Label Set (V2) – ECG, SpO2, NIBP, IP, German
3305642-046	21501-002546	1	Label Set (V2) – ECG, SpO2, NIBP, CO2, IP, German
3305642-047	21501-002547	1	Label Set (V2) – ECG, SpO2, NIBP, CO2, Temp, German
3305642-060	21501-002548	1	Label Set (V2) – ECG, Italian
3305642-061	21501-002549	1	Label Set (V2) – ECG, SpO2, Italian
3305642-062	21501-002550	1	Label Set (V2) – ECG, NIBP, SpO2, Italian
3305642-063	21501-002551	1	Label Set (V2) – ECG, SpO2, CO2, Italian
3305642-064	21501-002552	1	Label Set (V2) – ECG, SpO2, NIBP, CO2, Italian
3305642-065	21501-002553	1	Label Set (V2) – ECG, SpO2, NIBP, IP, Italian
3305642-066	21501-002554	1	Label Set (V2) – ECG, SpO2, NIBP, CO2, IP, Italian
3305642-067	21501-002555	1	Label Set (V2) – ECG, SpO2, NIBP, CO2, Temp, Italian
3305642-080	21501-002480	1	Label Set (V2) – ECG, French
3305642-081	21501-002481	1	Label Set (V2) – ECG, SpO2, French
3305642-082	21501-002482	1	Label Set (V2) – ECG, NIBP, SpO2, French

**Table 11.15—Label Set Part Numbers (V2) (Continued)**

MIN	CAT.	Qty	Part Description
3305642-083	21501-002483	1	Label Set (V2) – ECG, SpO2, CO2, French
3305642-084	21501-002484	1	Label Set (V2) – ECG, SpO2, NIBP, CO2, French
3305642-085	21501-002485	1	Label Set (V2) – ECG, SpO2, NIBP, IP, French
3305642-086	21501-002486	1	Label Set (V2) – ECG, SpO2, NIBP, CO2, IP, French
3305642-087	21501-002487	1	Label Set (V2) – ECG, SpO2, NIBP, CO2, Temp, French
3305642-100	21501-002488	1	Label Set (V2) – ECG, Dutch
3305642-101	21501-002489	1	Label Set (V2) – ECG, SpO2, Dutch
3305642-102	21501-002527	1	Label Set (V2) – ECG, NIBP, SpO2, Dutch
3305642-103	21501-002528	1	Label Set (V2) – ECG, SpO2, CO2, Dutch
3305642-104	21501-002529	1	Label Set (V2) – ECG, SpO2, NIBP, CO2, Dutch
3305642-105	21501-002530	1	Label Set (V2) – ECG, SpO2, NIBP, IP, Dutch
3305642-106	21501-002536	1	Label Set (V2) – ECG, SpO2, NIBP, CO2, IP, Dutch
3305642-107	21501-002500	1	Label Set (V2) – ECG, SpO2, NIBP, CO2, Temp, Dutch

**Table 11.15—Label Set Part Numbers (V2) (Continued)**

MIN	CAT.	Qty	Part Description
3305642-120	21501-002531	1	Label Set (V2) – ECG, Spanish
3305642-121	21501-002532	1	Label Set (V2) – ECG, SpO2, Spanish
3305642-122	21501-002533	1	Label Set (V2) – ECG, NIBP, SpO2, Spanish
3305642-123	21501-002534	1	Label Set (V2) – ECG, SpO2, CO2, Spanish
3305642-124	21501-002535	1	Label Set (V2) – ECG, SpO2, NIBP, CO2, Spanish
3305642-125	21501-002491	1	Label Set (V2) – ECG, SpO2, NIBP, IP, Spanish
3305642-126	21501-002493	1	Label Set (V2) – ECG, SpO2, NIBP, CO2, IP, Spanish
3305642-127	21501-002494	1	Label Set (V2) – ECG, SpO2, NIBP, CO2, Temp, Spanish
3305642-140	21501-002501	1	Label Set (V2) – ECG, Portuguese
3305642-141	21501-002502	1	Label Set (V2) – ECG, SpO2, Portuguese
3305642-142	21501-002503	1	Label Set (V2) – ECG, NIBP, SpO2, Portuguese
3305642-143	21501-002504	1	Label Set (V2) – ECG, SpO2, CO2, Portuguese
3305642-144	21501-002505	1	Label Set (V2) – ECG, SpO2, NIBP, CO2, Portuguese

**Table 11.15—Label Set Part Numbers (V2) (Continued)**

MIN	CAT.	Qty	Part Description
3305642-145	21501-002506	1	Label Set (V2) – ECG, SpO2, NIBP, IP, Portuguese
3305642-146	21501-002507	1	Label Set (V2) – ECG, SpO2, NIBP, CO2, IP, Portuguese
3305642-147	21501-002508	1	Label Set (V2) – ECG, SpO2, NIBP, CO2, Temp, Portuguese
3305642-160	21501-002509	1	Label Set (V2) – ECG, Brazilian
3305642-161	21501-002557	1	Label Set (V2) – ECG, SpO2, Brazilian
3305642-162	21501-002558	1	Label Set (V2) – ECG, NIBP, SpO2, Brazilian
3305642-163	21501-002559	1	Label Set (V2) – ECG, SpO2, CO2, Brazilian
3305642-164	21501-002560	1	Label Set (V2) – ECG, SpO2, NIBP, CO2, Brazilian
3305642-165	21501-002561	1	Label Set (V2) – ECG, SpO2, NIBP, IP, Brazilian
3305642-166	21501-002562	1	Label Set (V2) – ECG, SpO2, NIBP, CO2, IP, Brazilian
3305642-167	21501-002556	1	Label Set (V2) – ECG, SpO2, NIBP, CO2, Temp, Brazilian
3305642-180	21501-002510	1	Label Set (V2) – ECG, Swedish
3305642-181	21501-002511	1	Label Set (V2) – ECG, SpO2, Swedish

**Table 11.15—Label Set Part Numbers (V2) (Continued)**

MIN	CAT.	Qty	Part Description
3305642-182	21501-002512	1	Label Set (V2) – ECG, NIBP, SpO2, Swedish
3305642-183	21501-002513	1	Label Set (V2) – ECG, SpO2, CO2, Swedish
3305642-184	21501-002490	1	Label Set (V2) – ECG, SpO2, NIBP, CO2, Swedish
3305642-185	21501-002492	1	Label Set (V2) – ECG, SpO2, NIBP, IP, Swedish
3305642-186	21501-002495	1	Label Set (V2) – ECG, SpO2, NIBP, CO2, IP, Swedish
3305642-187	21501-002496	1	Label Set (V2) – ECG, SpO2, NIBP, CO2, Temp, Swedish
3305642-200	21501-002497	1	Label Set (V2) – ECG, Danish
3305642-201	21501-002498	1	Label Set (V2) – ECG, SpO2, Danish
3305642-202	21501-002499	1	Label Set (V2) – ECG, NIBP, SpO2, Danish
3305642-203	21501-002514	1	Label Set (V2) – ECG, SpO2, CO2, Danish
3305642-204	21501-002515	1	Label Set (V2) – ECG, SpO2, NIBP, CO2, Danish
3305642-205	21501-002516	1	Label Set (V2) – ECG, SpO2, NIBP, IP, Danish
3305642-206	21501-002517	1	Label Set (V2) – ECG, SpO2, NIBP, CO2, IP, Danish



**Table 11.15—Label Set Part Numbers (V2) (Continued)**

MIN	CAT.	Qty	Part Description
3305642-207	21501-002518	1	Label Set (V2) – ECG, SpO2, NIBP, CO2, Temp, Danish
3305642-220	21501-002519	1	Label Set (V2) – ECG, Finnish
3305642-221	21501-002520	1	Label Set (V2) – ECG, SpO2, Finnish
3305642-222	21501-002521	1	Label Set (V2) – ECG, NIBP, SpO2, Finnish
3305642-223	21501-002522	1	Label Set (V2) – ECG, SpO2, CO2, Finnish
3305642-224	21501-002523	1	Label Set (V2) – ECG, SpO2, NIBP, CO2, Finnish
3305642-225	21501-002524	1	Label Set (V2) – ECG, SpO2, NIBP, IP, Finnish
3305642-226	21501-002525	1	Label Set (V2) – ECG, SpO2, NIBP, CO2, IP, Finnish
3305642-227	21501-002526	1	Label Set (V2) – ECG, SpO2, NIBP, CO2, Temp, Finnish
3305642-240	21501-002537	1	Label Set (V2) – ECG, Norwegian
3305642-241	21501-002538	1	Label Set (V2) – ECG, SpO2, Norwegian
3305642-242	21501-002540	1	Label Set (V2) – ECG, NIBP, SpO2, Norwegian
3305642-243	21501-002539	1	Label Set (V2) – ECG, SpO2, CO2, Norwegian

**Table 11.15—Label Set Part Numbers (V2) (Continued)**

MIN	CAT.	Qty	Part Description
3305642-244	21501-002541	1	Label Set (V2) – ECG, SpO2, NIBP, CO2, Norwegian
3305642-245	21501-002542	1	Label Set (V2) – ECG, SpO2, NIBP, IP, Norwegian
3305642-246	21501-002543	1	Label Set (V2) – ECG, SpO2, NIBP, CO2, IP, Norwegian
3305642-247	21501-002544	1	Label Set (V2) – ECG, SpO2, NIBP, CO2, Temp, Norwegian
3305642-260	21501-002563	1	Label Set (V2) – ECG, Polish
3305642-261	21501-002564	1	Label Set (V2) – ECG, SpO2, Polish
3305642-262	21501-002565	1	Label Set (V2) – ECG, NIBP, SpO2, Polish
3305642-263	21501-002566	1	Label Set (V2) – ECG, SpO2, CO2, Polish
3305642-264	21501-002567	1	Label Set (V2) – ECG, SpO2, NIBP, CO2, Polish
3305642-265	21501-002568	1	Label Set (V2) – ECG, SpO2, NIBP, IP, Polish
3305642-266	21501-002569	1	Label Set (V2) – ECG, SpO2, NIBP, CO2, IP, Polish
3305642-267	21501-002570	1	Label Set (V2) – ECG, SpO2, NIBP, CO2, Temp, Polish
3305642-280	21501-002571	1	Label Set (V2) – ECG, Hungarian

**Table 11.15—Label Set Part Numbers (V2) (Continued)**

MIN	CAT.	Qty	Part Description
3305642-281	21501-002572	1	Label Set (V2) – ECG, SpO2, Hungarian
3305642-282	21501-002573	1	Label Set (V2) – ECG, NIBP, SpO2, Hungarian
3305642-283	21501-002574	1	Label Set (V2) – ECG, SpO2, CO2, Hungarian
3305642-284	21501-002575	1	Label Set (V2) – ECG, SpO2, NIBP, CO2, Hungarian
3305642-285	21501-002576	1	Label Set (V2) – ECG, SpO2, NIBP, IP, Hungarian
3305642-286	21501-002577	1	Label Set (V2) – ECG, SpO2, NIBP, CO2, IP, Hungarian
3305642-287	21501-002578	1	Label Set (V2) – ECG, SpO2, NIBP, CO2, Temp, Hungarian
3305642-300	21501-002579	1	Label Set (V2) – ECG, Czech
3305642-301	21501-002580	1	Label Set (V2) – ECG, SpO2, Czech
3305642-302	21501-002581	1	Label Set (V2) – ECG, NIBP, SpO2, Czech
3305642-303	21501-002582	1	Label Set (V2) – ECG, SpO2, CO2, Czech
3305642-304	21501-002583	1	Label Set (V2) – ECG, SpO2, NIBP, CO2, Czech
3305642-305	21501-002584	1	Label Set (V2) – ECG, SpO2, NIBP, IP, Czech

**Table 11.15—Label Set Part Numbers (V2) (Continued)**

MIN	CAT.	Qty	Part Description
3305642-306	21501-002585	1	Label Set (V2) – ECG, SpO2, NIBP, CO2, IP, Czech
3305642-307	21501-002586	1	Label Set (V2) – ECG, SpO2, NIBP, CO2, Temp, Czech
3305642-320	21501-002587	1	Label Set (V2) – ECG, Russian
3305642-321	21501-002588	1	Label Set (V2) – ECG, SpO2, Russian
3305642-322	21501-002589	1	Label Set (V2) – ECG, NIBP, SpO2, Russian
3305642-323	21501-002590	1	Label Set (V2) – ECG, SpO2, CO2, Russian
3305642-324	21501-002591	1	Label Set (V2) – ECG, SpO2, NIBP, CO2, Russian
3305642-325	21501-002592	1	Label Set (V2) – ECG, SpO2, NIBP, IP, Russian
3305642-326	21501-002593	1	Label Set (V2) – ECG, SpO2, NIBP, CO2, IP, Russian
3305642-327	21501-002594	1	Label Set (V2) – ECG, SpO2, NIBP, CO2, Temp, Russian
3305642-380	21501-002595	1	Label Set (V2) – ECG, Korean
3305642-381	21501-002596	1	Label Set (V2) – ECG, SpO2, Korean
3305642-382	21501-002597	1	Label Set (V2) – ECG, NIBP, SpO2, Korean

Table 11.15—Label Set Part Numbers (V2) (Continued)

MIN	CAT.	Qty	Part Description
3305642-383	21501-002598	1	Label Set (V2) – ECG, SpO2, CO2, Korean
3305642-384	21501-002599	1	Label Set (V2) – ECG, SpO2, NIBP, CO2, Korean
3305642-385	21501-002600	1	Label Set (V2) – ECG, SpO2, NIBP, IP, Korean
3305642-386	21501-002601	1	Label Set (V2) – ECG, SpO2, NIBP, CO2, IP, Korean
3305642-387	21501-002602	1	Label Set (V2) – ECG, SpO2, NIBP, CO2, Temp, Korean

### Connection Diagrams for Assemblies, Control Boards, Cables, and Connectors

This section included diagrams for the following assemblies and parts:

- Therapy PCB (p. 565)
- Power PCB (p. 564)
- System PCB (p. 563)
- Interface PCB (p. 566)
- OEM PCB Module (p. 567)
- Contact PCB Module (p. 568)
- Backlight PCB (p. 569)
- Printer Control Keypad (p. 570)
- Main Keypad (p. 571)
- LCD Assembly (p. 572)
- Printer Assembly (p. 573)
- Transfer Relay Assembly (p. 574)
- Inductive Resistor (p. 575)
- Energy Storage Capacitor (p. 576)
- SpO2 Module (p. 577)
- Interconnect Bracket (p. 578)
- NIBP Module (p. 579)
- Biphasic Module (p. 580)
- CO2 Module (p. 581)
- Power PCB/System PCB Cable (p. 582)
- Power PCB/Therapy PCB Cable (p. 583)
- System PCB/Therapy PCB Connector (p. 584)
- System PCB/Interface PCB Cable (p. 585)
- Power PCB/Contact PCB Cable (p. 586)
- Backlight PCB/Interface PCB Cable (p. 587)
- ECG Connector Cable (p. 588)
- System Connector Cable (p. 589)
- Battery Pins/Power PCB Cable (p. 591)
- Therapy Connector Cable (p. 592)
- Printer Control Keypad/Interface PCB Cable (p. 593)
- Main Keypad/Interface PCB Cable (p. 594)
- USB Flex Assembly (p. 595)
- Printer Assembly/Interface PCB Cable (p. 597)
- Speaker Assembly (p. 598)
- LCD Assembly/Interface PCB Cable (p. 599)
- Printer Assembly/Chassis Ground Cable (p. 600)
- Biphasic to Therapy PCB Flex Cable (p. 601)
- OEM PCB/SpO2 Module Cable (p. 602)
- SpO2 Connector Cable (p. 603)
- OEM PCB/CO2 Module Cable (p. 604)
- OEM PCB/NIBP Module Cable (p. 605)
- OEM PCB/NIBP Module Cable (p. 605)
- CO2 Inlet Connector Cable (p. 606)
- Temperature Connector Cable Assembly (p. 609)

### System PCB

Refer to [System/Therapy PCB Assembly Diagrams and Parts List \(p. 507\)](#) and [Figure 11.9: System/Therapy PCB assembly view 2 of 2, p. 508](#)

See also MIN 3206834 in table for parts information.

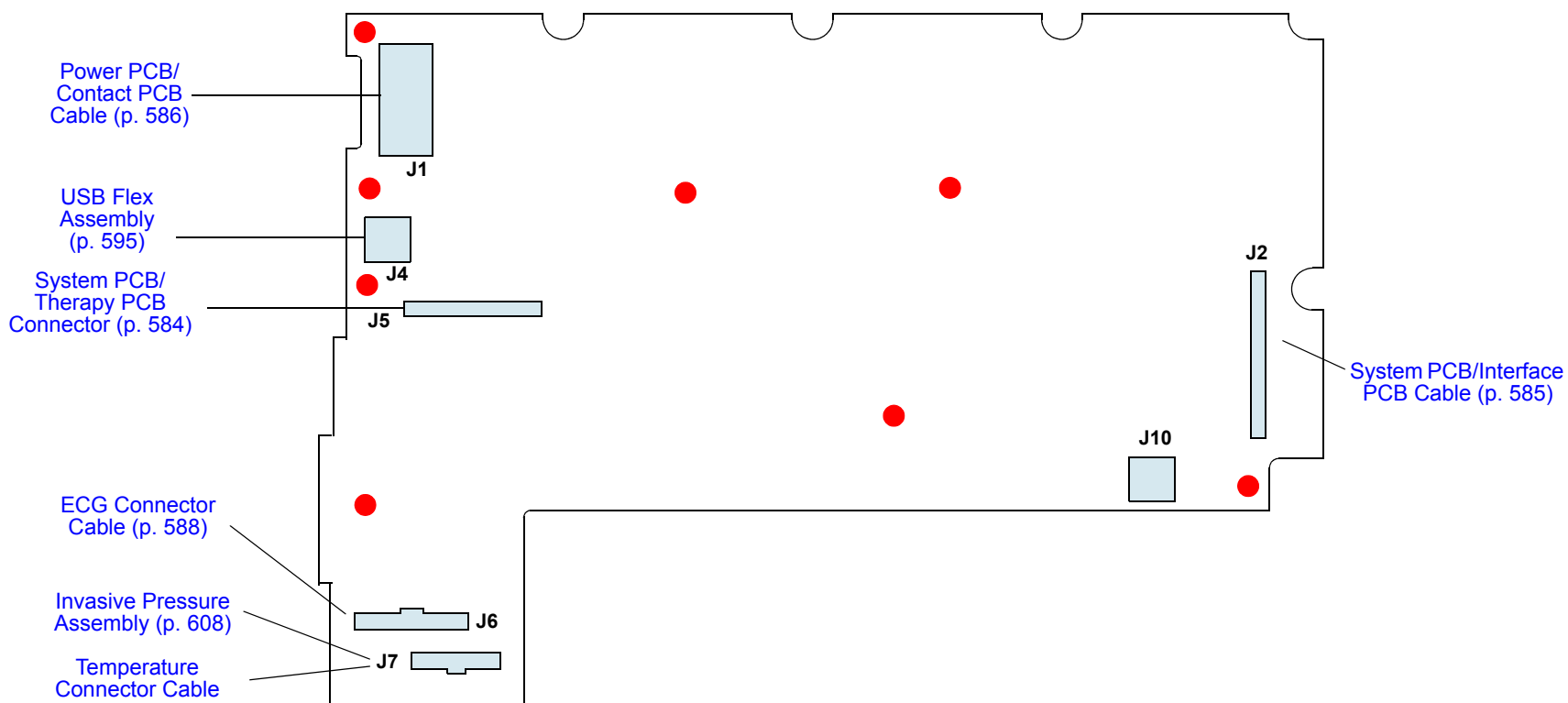

Figure 11.22—Diagram for item A01

### Power PCB

Refer to [Figure 11.17: Rear Case view 4 of 7, p. 523](#).  
See MIN [3206749-003](#) in table for parts information.

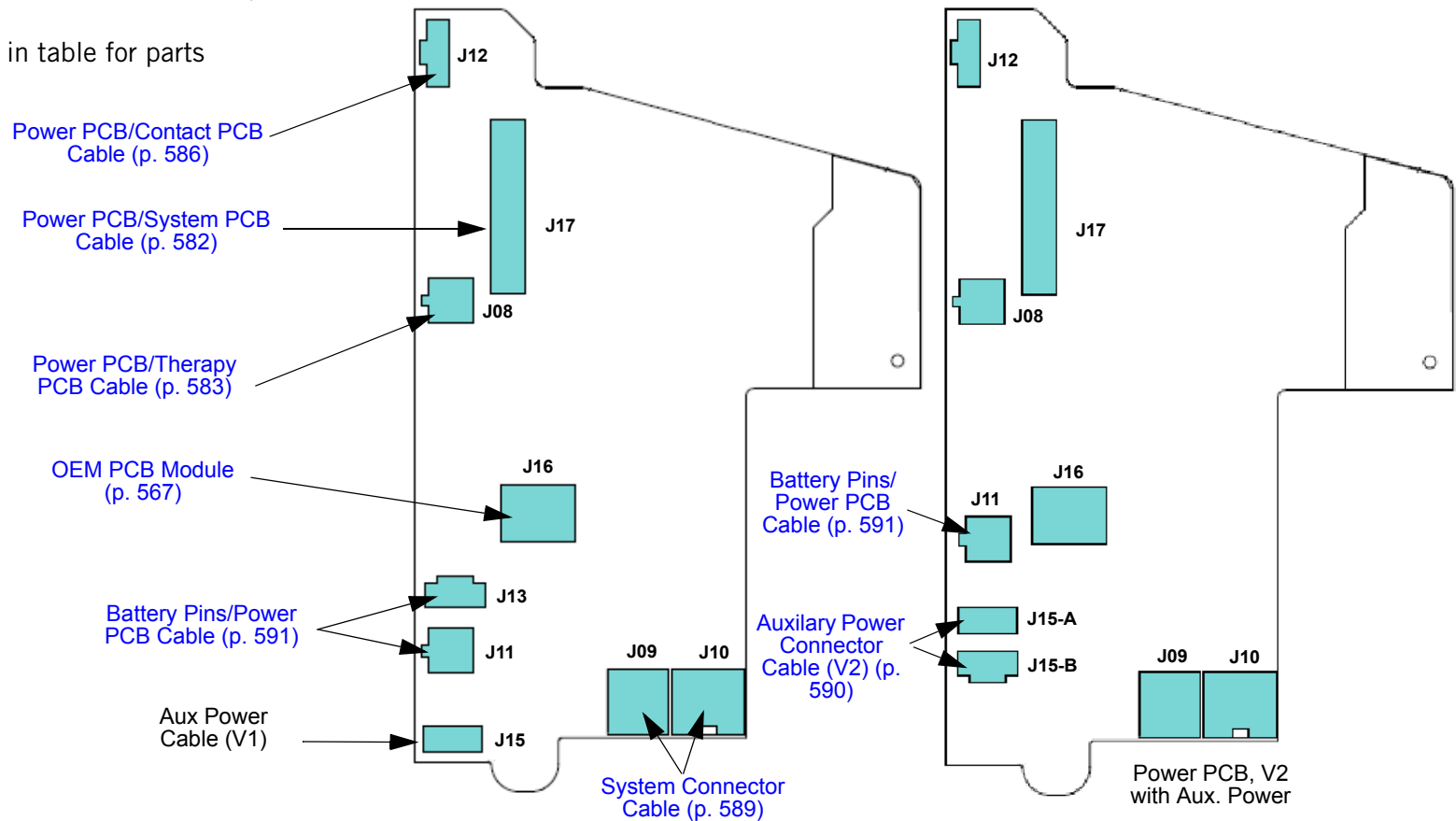

Figure 11.23—Diagram for item A03



### Therapy PCB

Refer to [System/Therapy PCB Assembly Diagrams and Parts List \(p. 507\)](#) and [Figure 11.9: System/Therapy PCB assembly view 2 of 2, p. 508](#)

See also [MIN 3306311](#) in table for parts information.

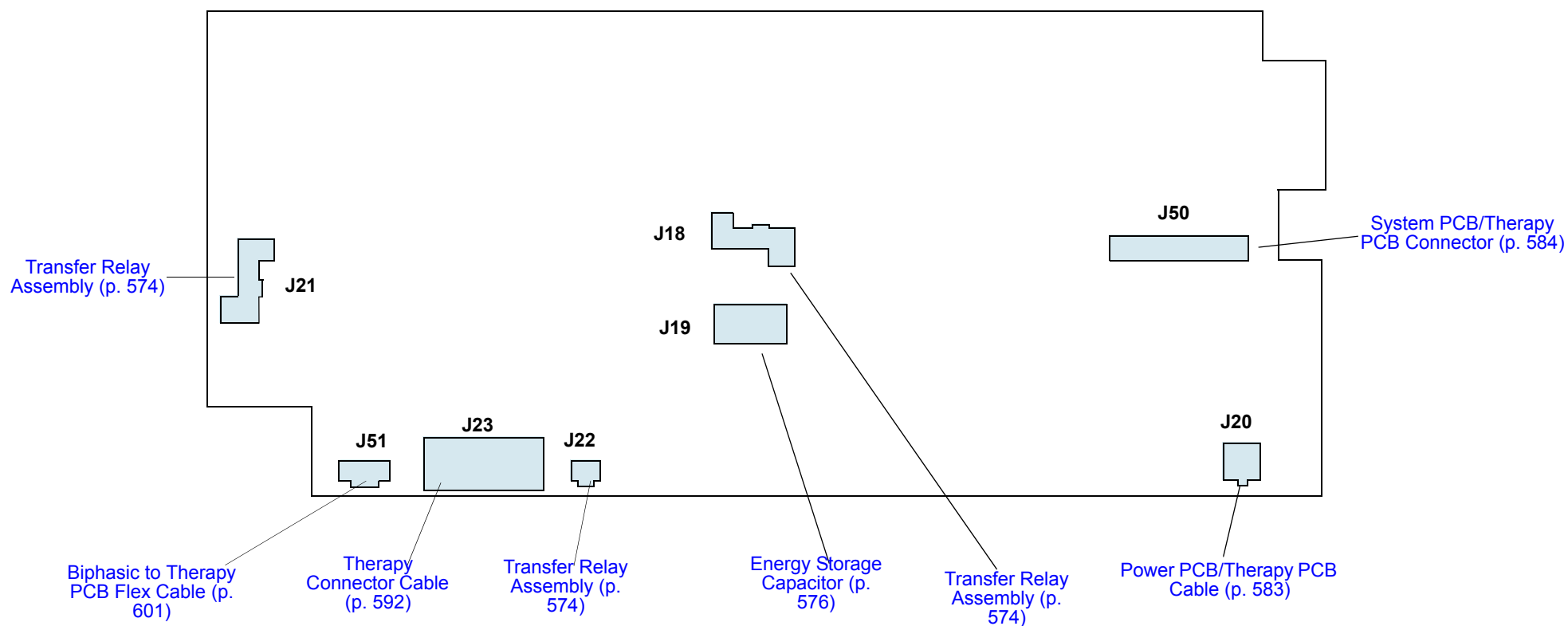

Figure 11.24—Diagram for item A04

### Interface PCB

Refer to [Figure 11.6: Front Case parts view 2 of 3, p. 499](#).  
See MIN 3206815 in table for parts information.

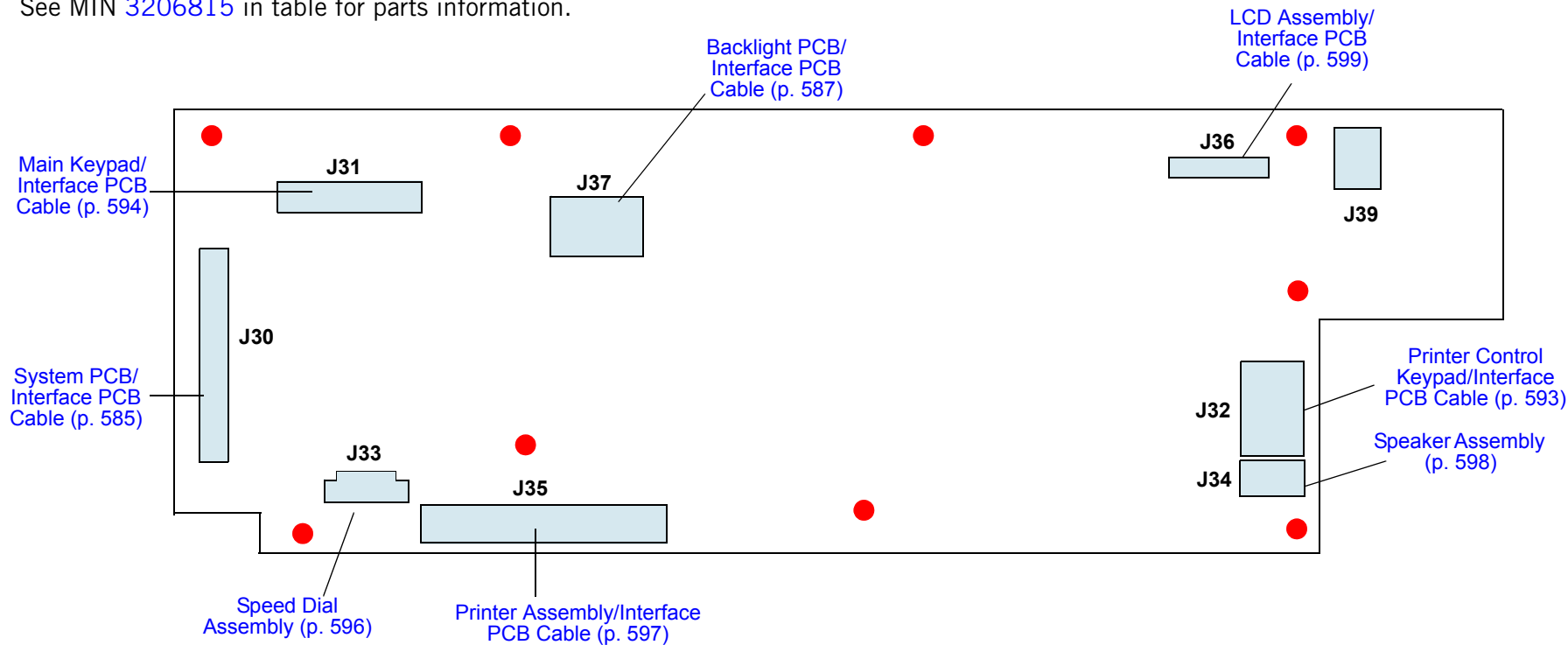

Figure 11.25—Diagram for item A05

### OEM PCB Module

Refer to [Figure 11.18: Rear Case view 5 of 7, p. 524](#).  
See MIN 3206813-003 in table for parts information.

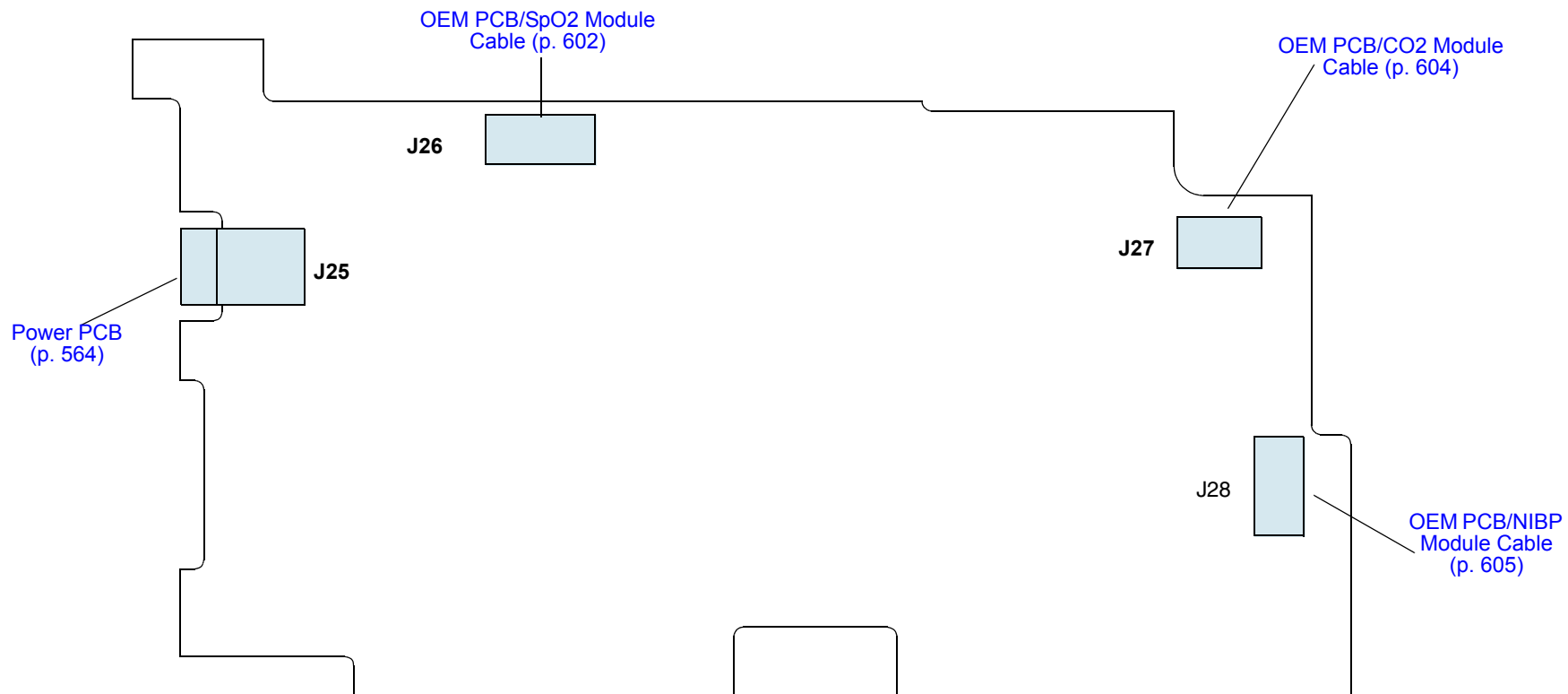

Figure 11.26—Diagram for item A06

### Contact PCB Module

Refer to [Figure 11.14: Rear Case view 1 of 7, p. 520](#).  
See MIN [3207037-002](#) in table for parts information.

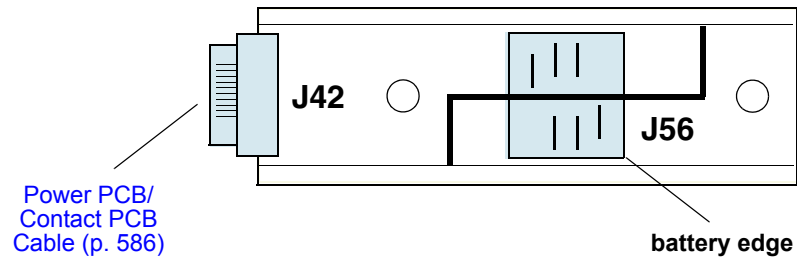

Figure 11.27—Diagram for item A07

### Backlight PCB

Refer to [Figure 11.6: Front Case parts view 2 of 3, p. 499.](#)  
See MIN 3207933-000 in table for parts information.

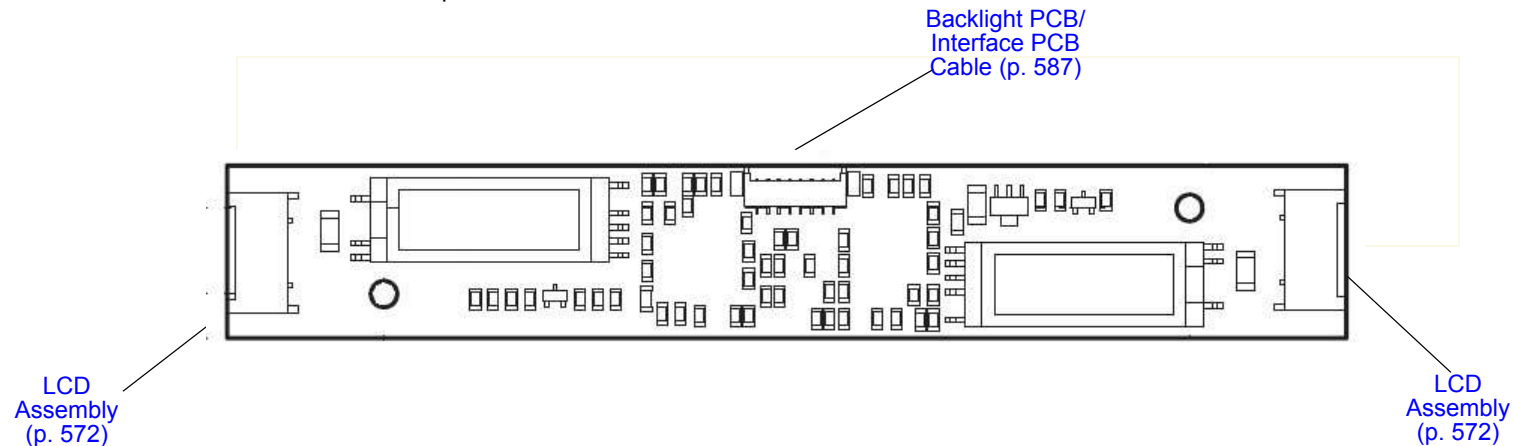

Figure 11.28—Diagram for item A08

### Printer Control Keypad

Refer to [External and Configured Parts Diagram — Page 1 of 2 \(p. 492\)](#).  
See MIN [3207080-XXX](#) in table for parts information.

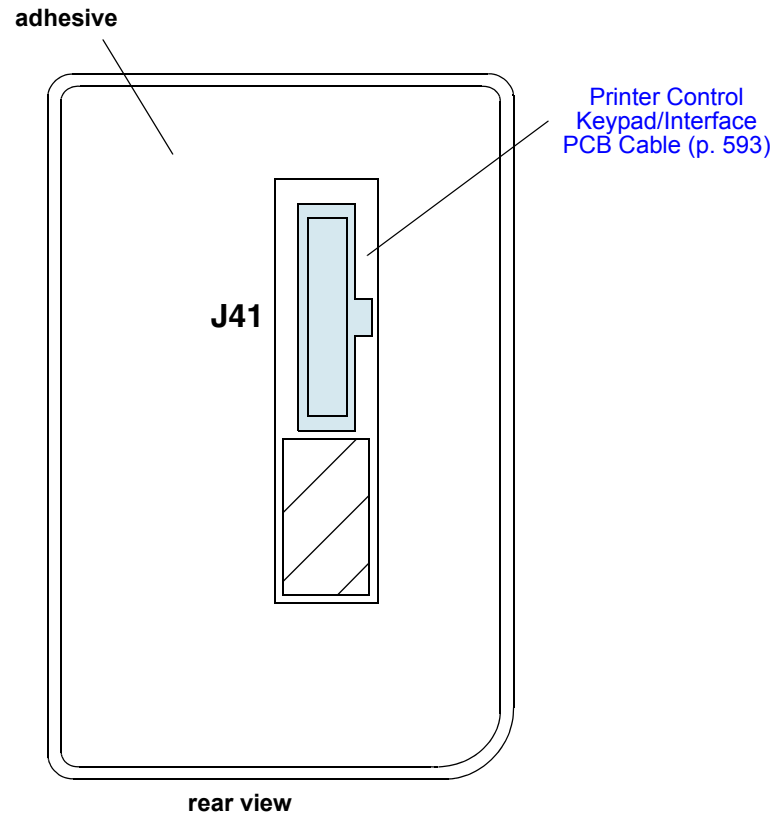

Figure 11.29—Diagram for item A09

### Main Keypad

Refer to [External and Configured Parts Diagram — Page 1 of 2 \(p. 492\)](#).

See MIN [3207079-XXX](#) in table for parts information.

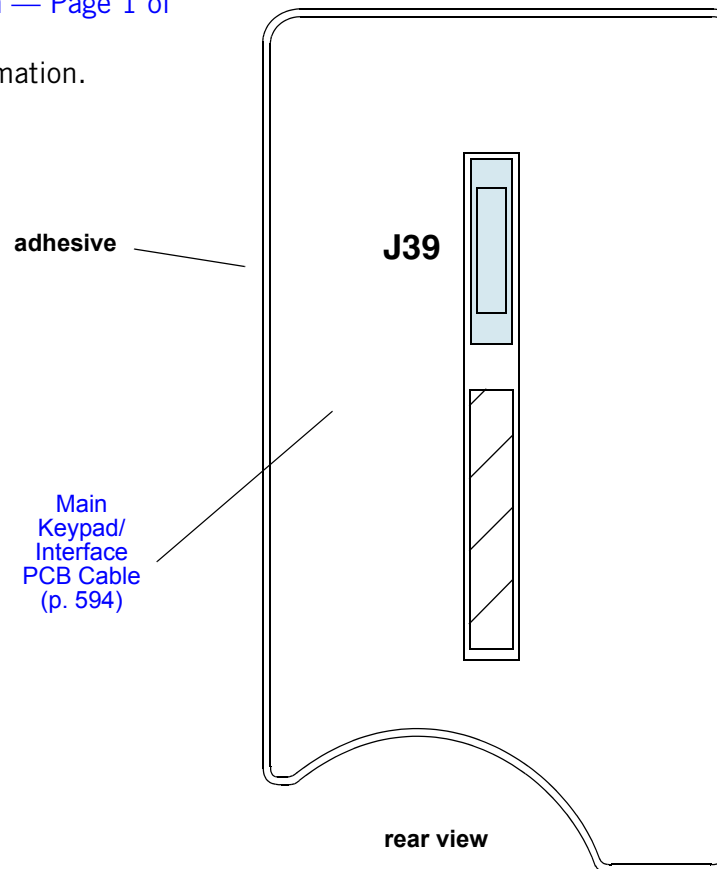

Figure 11.30—Diagram for item A10

### LCD Assembly

Refer to [Figure 11.6: Front Case parts view 2 of 3, p. 499](#).  
See MIN [3203221](#) in table for parts information.

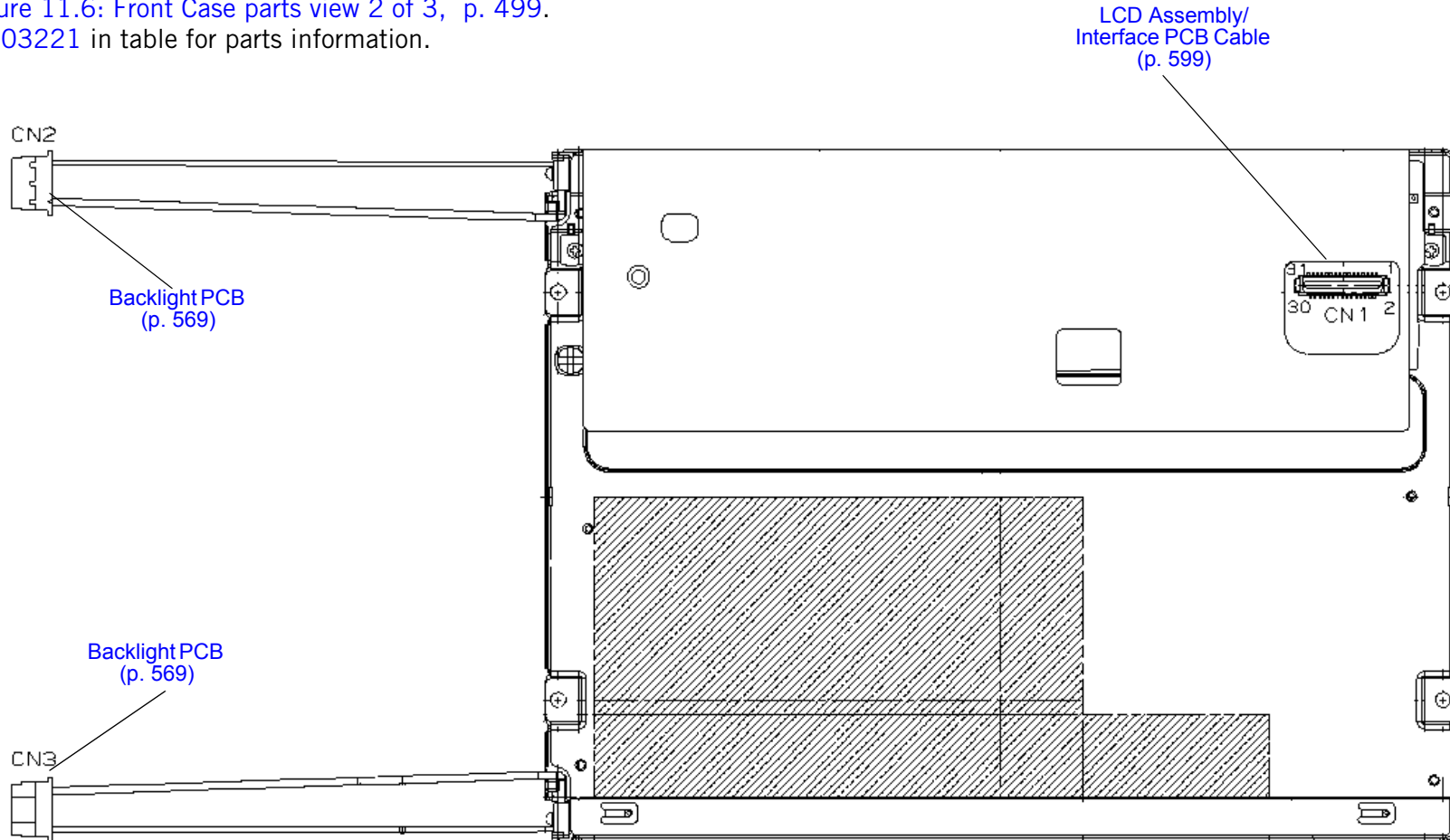
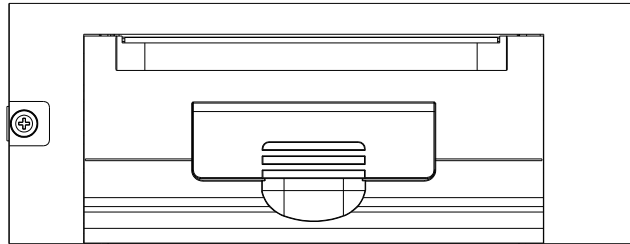

Figure 11.31—Diagram for item A11



### Printer Assembly

See MIN [3208290-000](#) in table for parts information.



100-mm printer

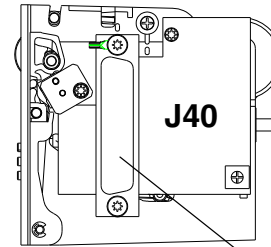

Printer Assembly/  
Interface PCB Cable  
(p. 597)

Figure 11.32—Diagram for item A12

### Transfer Relay Assembly

Refer to [Figure 11.18: Rear Case view 5 of 7, p. 524](#).  
See [MIN 3201583-001](#) in table for parts information.

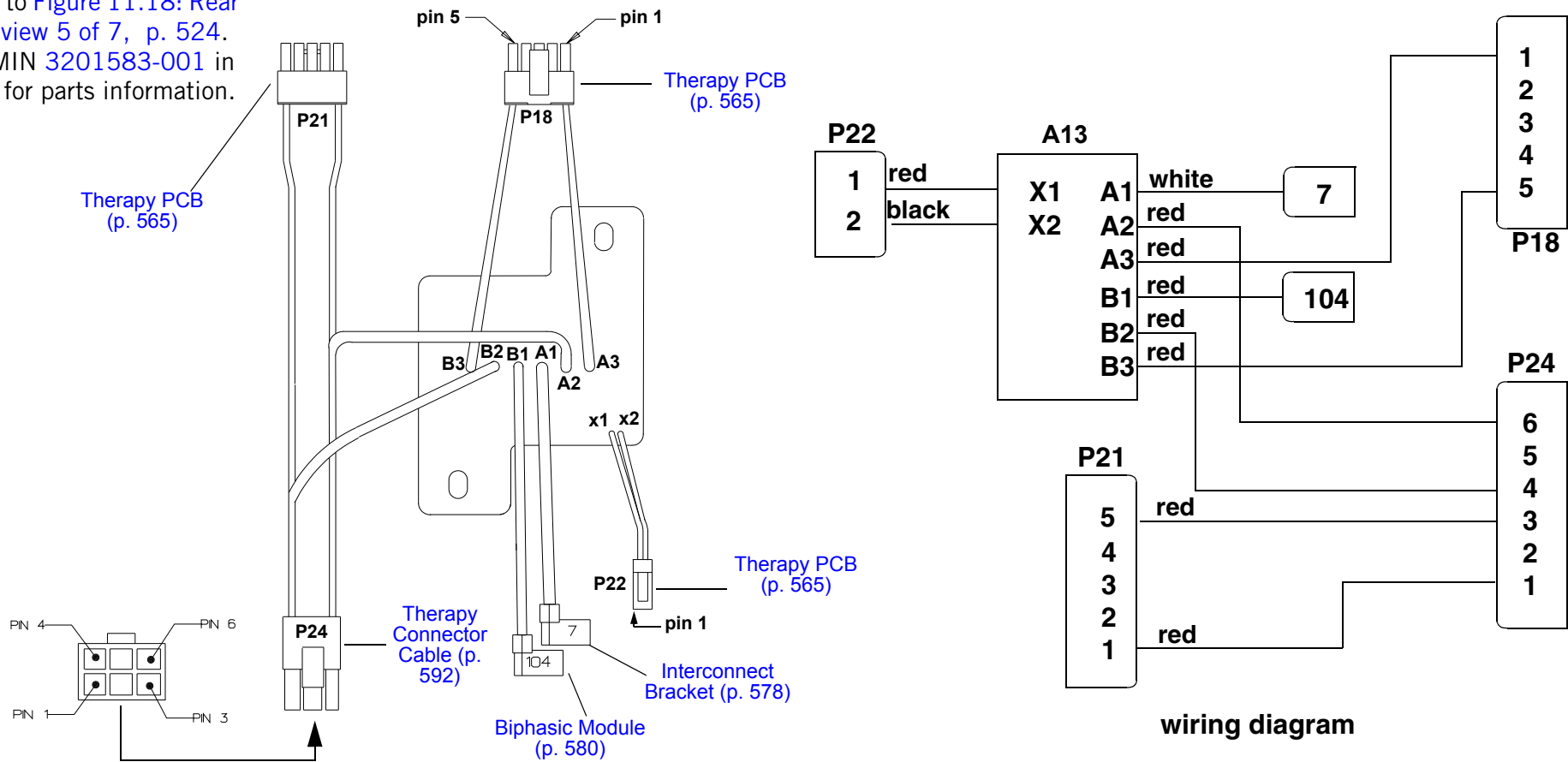

Figure 11.33—Diagram for item A13

### Inductive Resistor

Refer to [Figure 11.18: Rear Case view 5 of 7, p. 524.](#)  
See MIN [3010212-02](#) in table for parts information.

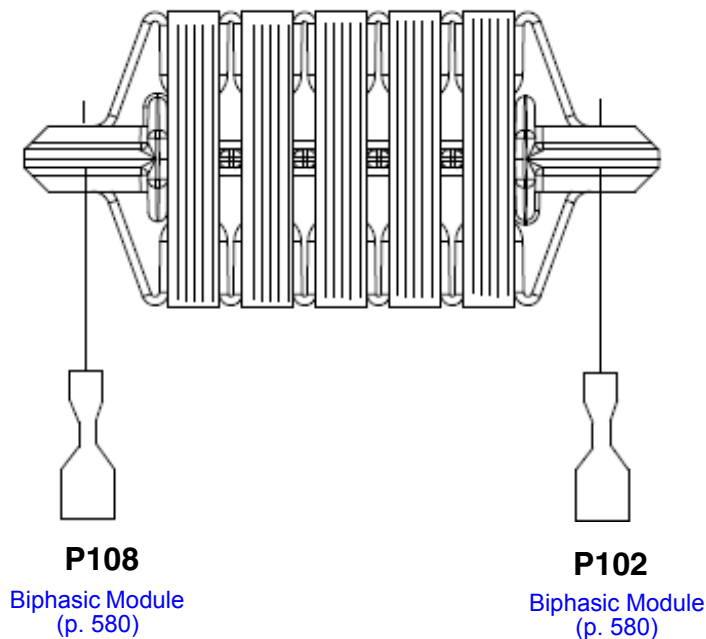

Figure 11.34—Diagram for item A14

### Energy Storage Capacitor

Refer to [Figure 11.18: Rear Case view 5 of 7, p. 524.](#)  
See MIN [3008164-002](#) in table for parts information.

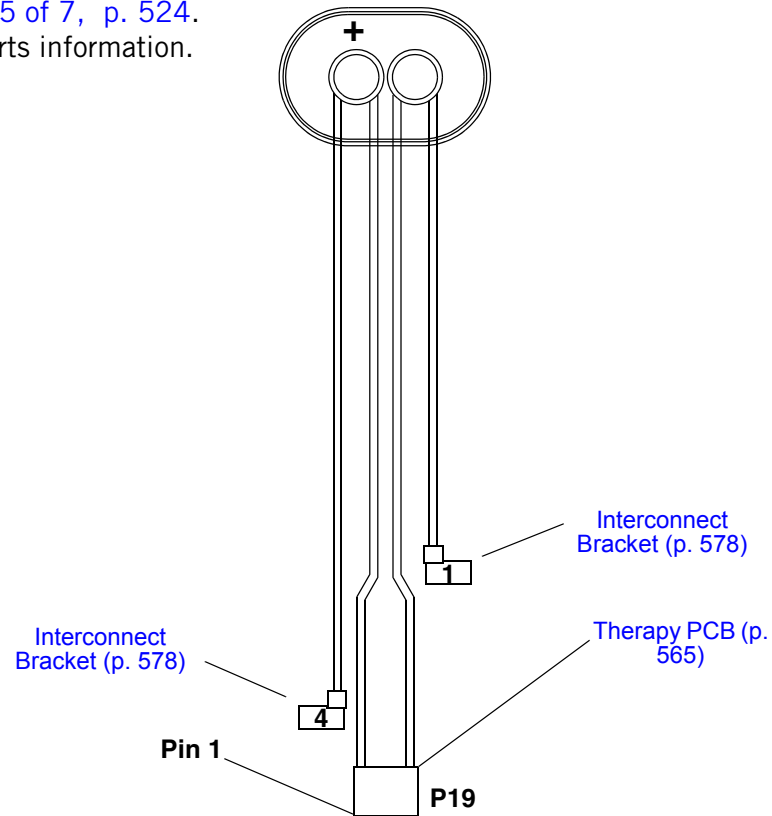

Figure 11.35—Diagram for item A15

### SpO2 Module

Refer to [Figure 11.21: NIPB, CO2, and SpO2 view 1 of 1, p. 533.](#)

See MIN [3207034-002](#) in table for parts information.

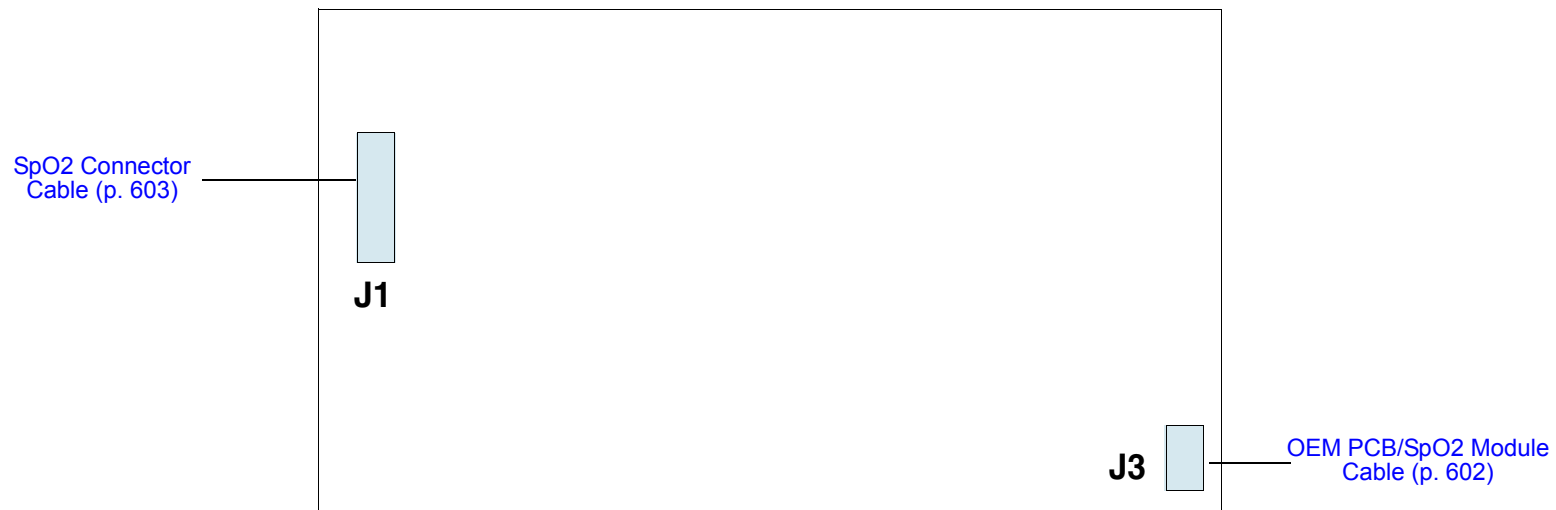
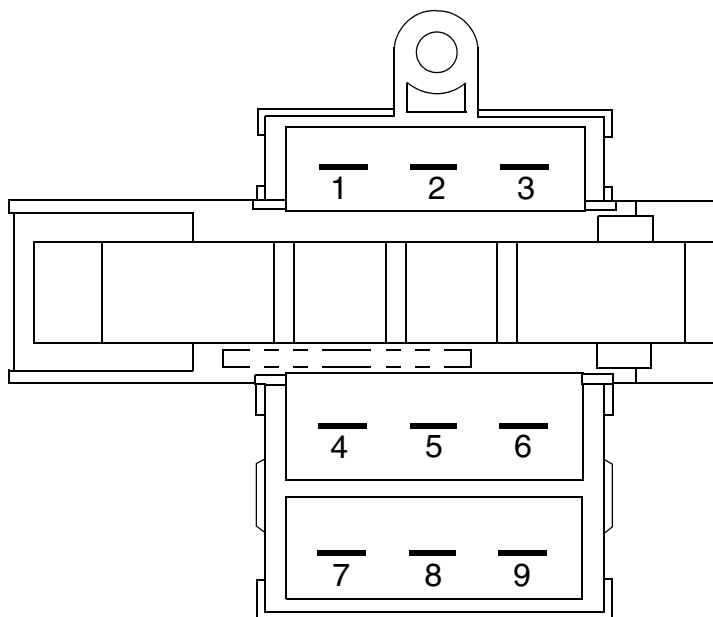

Figure 11.36—Diagram for item A16

### Interconnect Bracket

Refer to [Figure 11.18: Rear Case view 5 of 7, p. 524.](#)  
See MIN [3008897-002](#) in table for parts information.



Connection Chart	
A17 -pin 1	Cap Neg (wht)
A17 -pin 3	BTE J101
A17 -pin 4	Cap Pos (red)
A17 -pin 6	BTE J105
A17 -pin 7	Relay pin 7
A17 -pin 9	BTE J103

Figure 11.37—Diagram for item A17

### NIBP Module

Refer to [Figure 11.21: NIPB, CO2, and SpO2 view 1 of 1, p. 533.](#)

See MIN [3206268](#) in table for parts information.

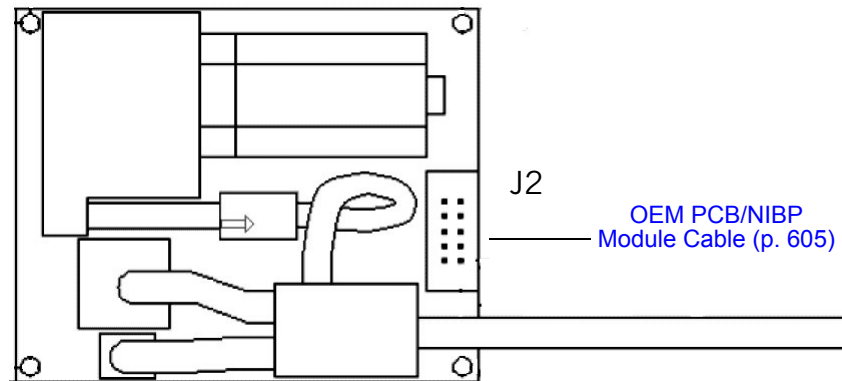

Figure 11.38—Diagram for item A21

### Biphasic Module

Refer to [Figure 11.18: Rear Case view 5 of 7, p. 524](#).  
See also MIN 3010178-010 in parts table.

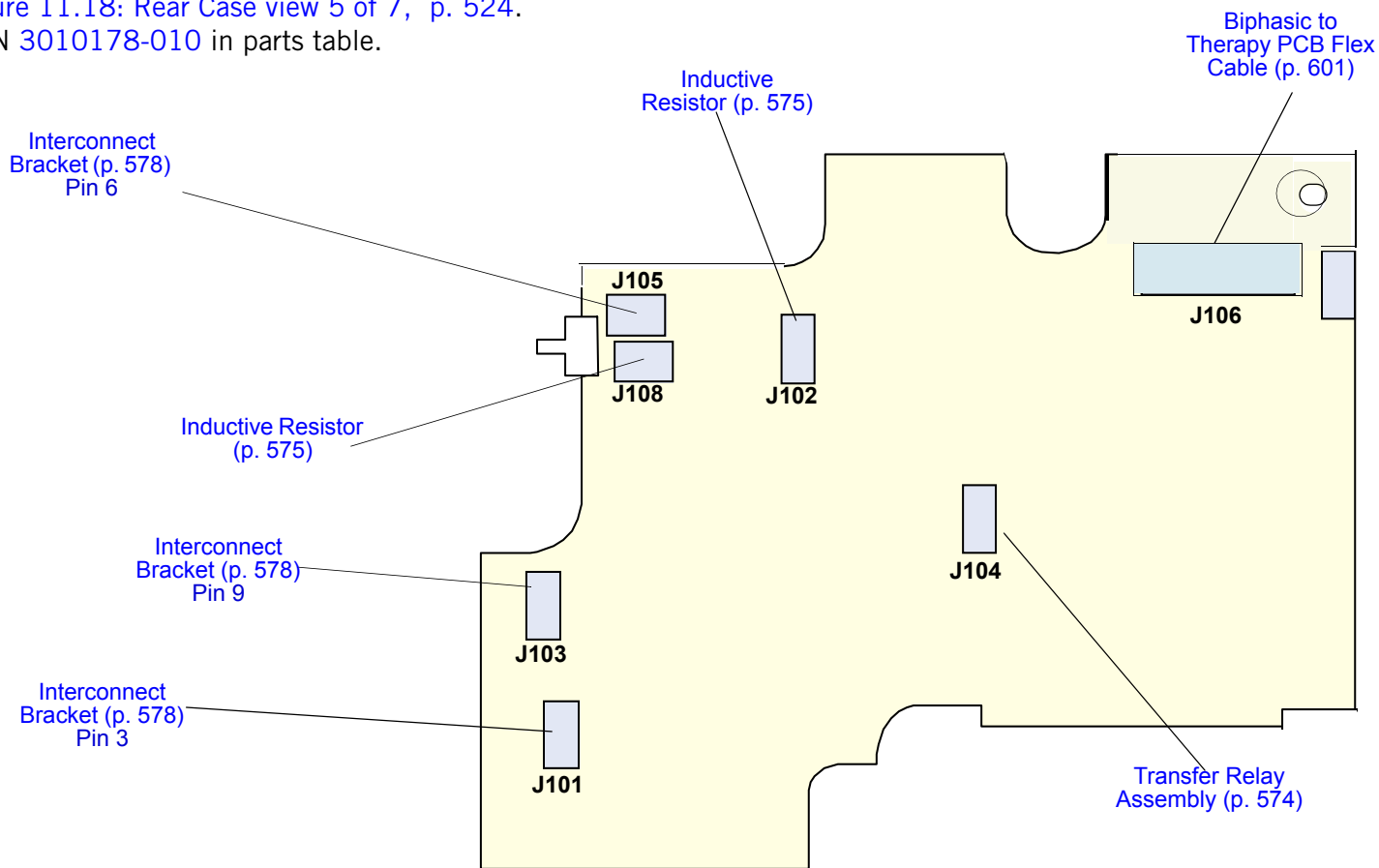

Figure 11.39—Diagram for item A22



### CO2 Module

Refer to [Figure 11.21: NIPB, CO2, and SpO2 view 1 of 1, p. 533.](#)  
See MIN [3012140-006](#) in table for parts information.

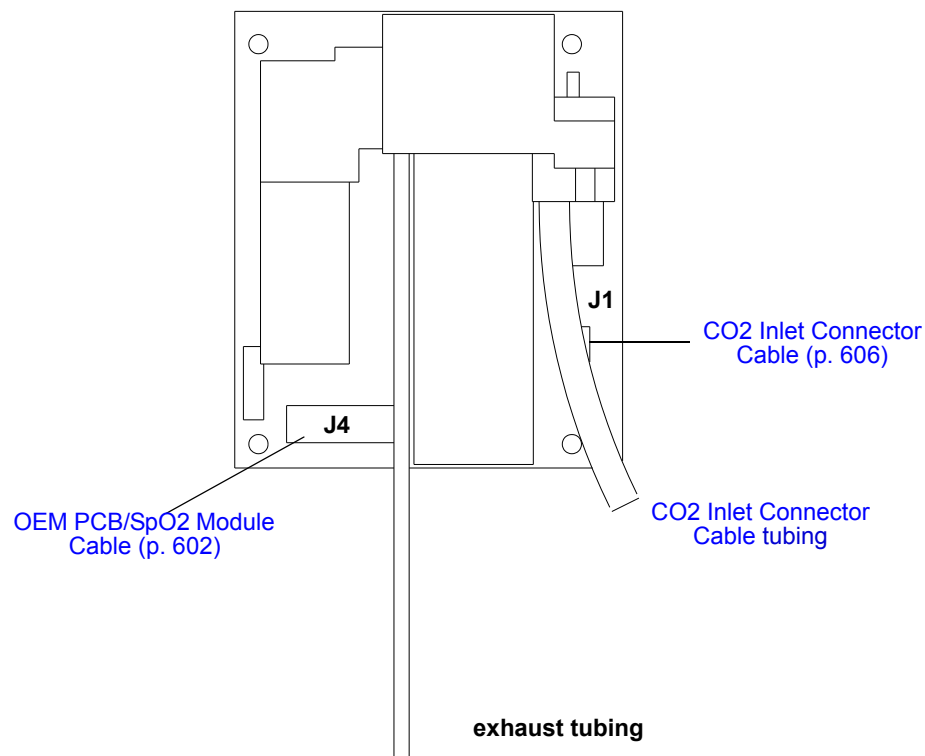

Figure 11.40—Diagram for item A23

### Power PCB/System PCB Cable

Refer to [Figure 11.17: Rear Case view 4 of 7, p. 523](#).  
See MIN 3207692-000 in table for parts information.

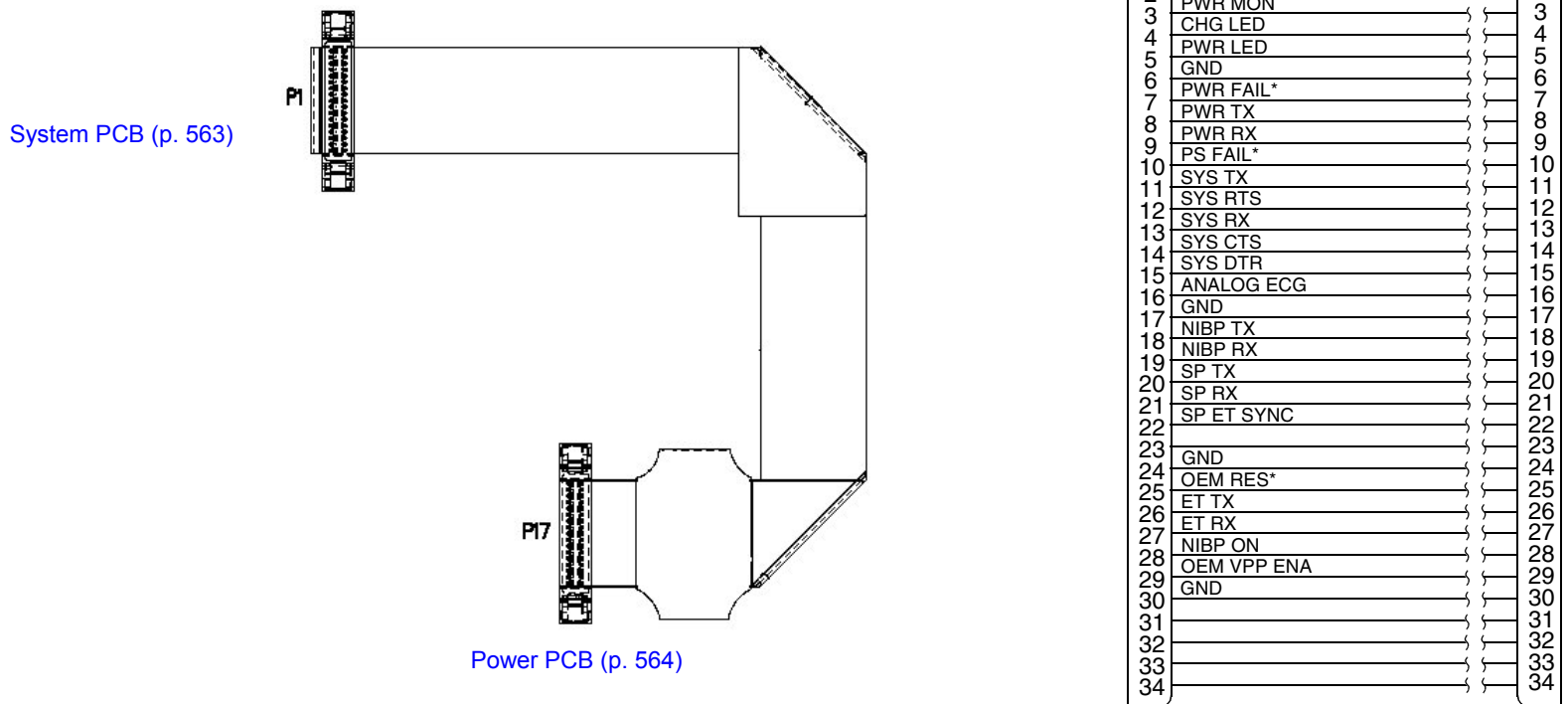

Figure 11.41—Diagram for item W01

### Power PCB/Therapy PCB Cable

Refer to [Figure 11.17: Rear Case view 4 of 7, p. 523](#).  
See MIN 3207692-000 in table for part information.

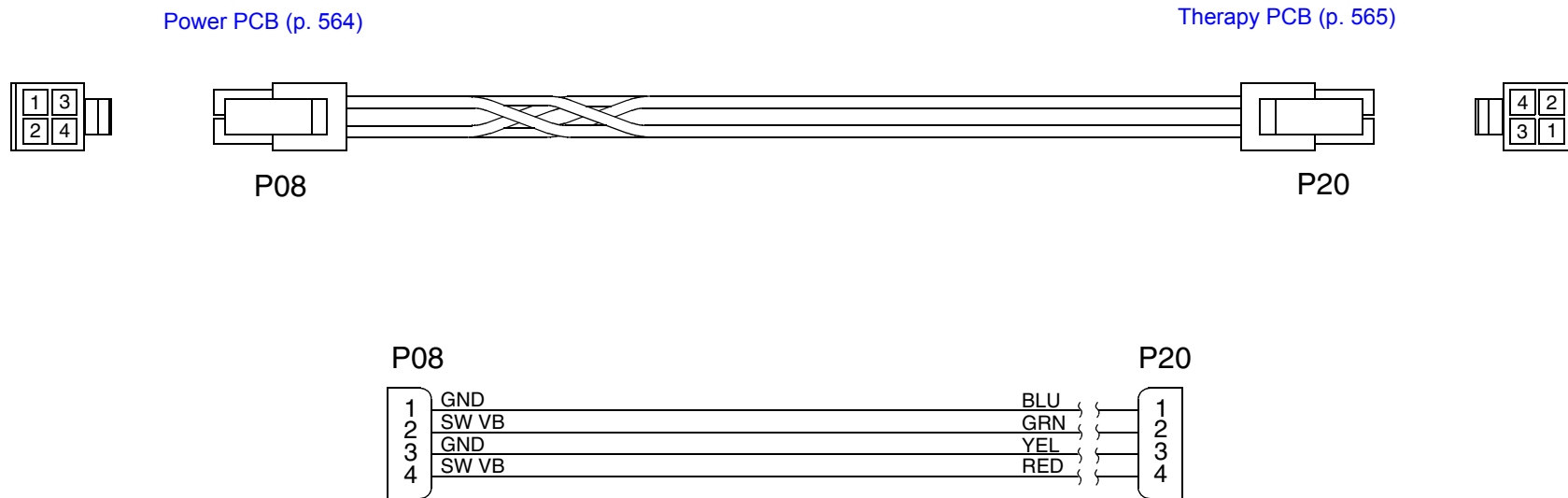

Figure 11.42—Diagram for item W02

### System PCB/Therapy PCB Connector

Refer to [Figure 11.17: Rear Case view 4 of 7, p. 523](#).  
See MIN 3207692-000 in table for part information.

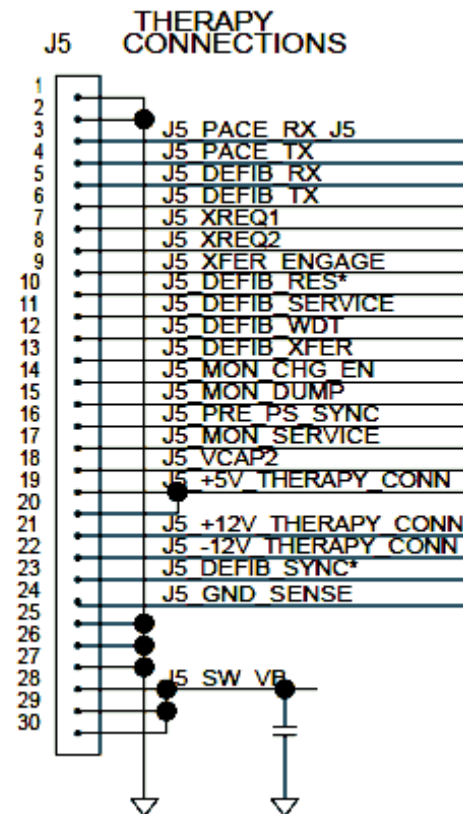
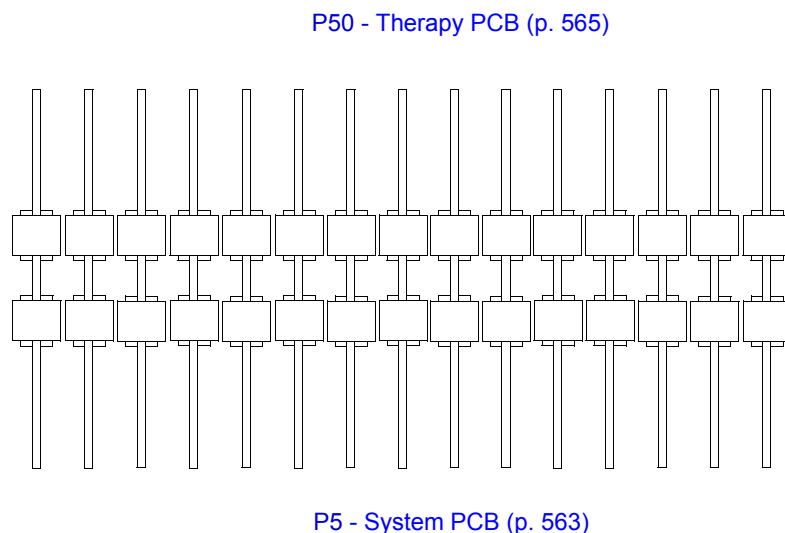
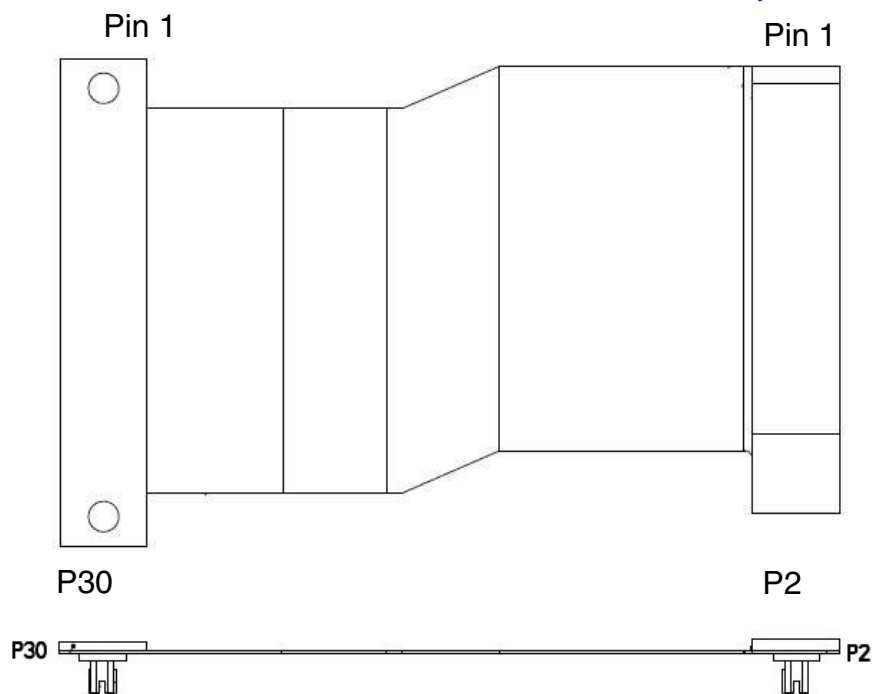

Figure 11.43—Diagram for item W03

### System PCB/Interface PCB Cable

Interface PCB (p. 566)

System PCB (p. 563)



Pinouts P2 to P30			
BT_DTR	1	2	BT_DSR
BT_GTS	3	4	BT_TXD
BT_RTS	5	6	BT_RXD
BT_GREEN	7	8	BT_BLUE
BT_RED_MODE*	9	10	LATCH
CLK	11	12	STB1
STB2	13	14	SW_VB_OUT
DATA	15	16	SW_VB_OUT
THERM2	17	18	PWR_SWITCH
POWER_LED	19	20	+5V_AUDIO
AUDIO	21	22	UC_SERIAL_IN
XREQ_2	23	24	SERVICE
BNC_ON	25	26	BNC_IN
BNC1_IN	27	28	UC_SHIFT_CTRL
UC_LED_CNTRL	29	30	UC_SHIFT_CLK
UC_SERIAL_OUT	31	32	A.C.LED
CHG_LED	33	34	EMITTER ANODE
SENSOR COLLECTOR	35	36	EMITTER CATHODE
+3.3_BT/LCD	37	38	LCD_BACKLIGHT_BN
BT_RESET*	39	40	+3.3LVDS
GND	41	42	GND
TX PAIR TX0-	43	44	GND
TX0+	45	46	GND
GND	47	48	GND
TX PAIR TX1-	49	50	GND
TX1+	51	52	GND
GND	53	54	GND
TX PAIR TX2-	55	56	GND
TX2+	57	58	GND
GND	59	60	GND
TX PAIR TXCLK-	61	62	GND
TXCLK+	63	64	GND
GND	65	66	GND
TX PAIR TX3-	67	68	GND
TX3+	69	70	GND
GND	71	72	GND
BACKLIGHT_CNTRL	73	74	VHD_PRINT
+5V_UC	75	76	VHD_PRINT
HEADTYPE	77	78	VHD_PRINT
MOTOR-	79	80	VHD_PRINT
MOTOR+	81	82	VHD_PRINT
RL_BACKPLANE	83	84	+5V_PRINT

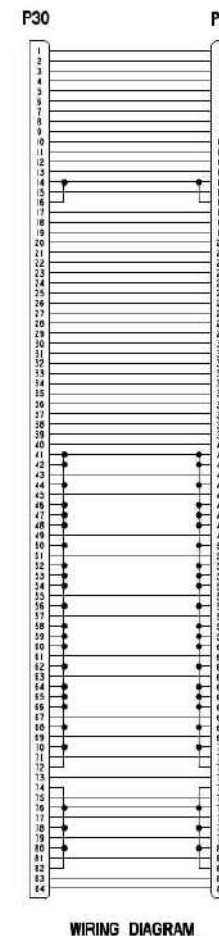

Figure 11.44—Diagram for item W04

### Power PCB/Contact PCB Cable

Refer to [Figure 11.17: Rear Case view 4 of 7, p. 523.](#)  
See MIN [3207261-001](#) in table for parts information.

Power PCB (p. 564)



Contact PCB Module

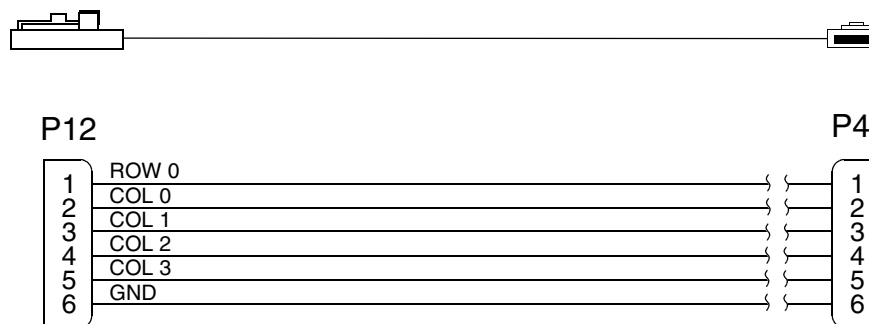

Figure 11.45—Diagram for item W05

### Backlight PCB/Interface PCB Cable

Refer to [Figure 11.6: Front Case parts view 2 of 3](#), p. 499.  
See MIN [3206992-000](#) in table for parts information.

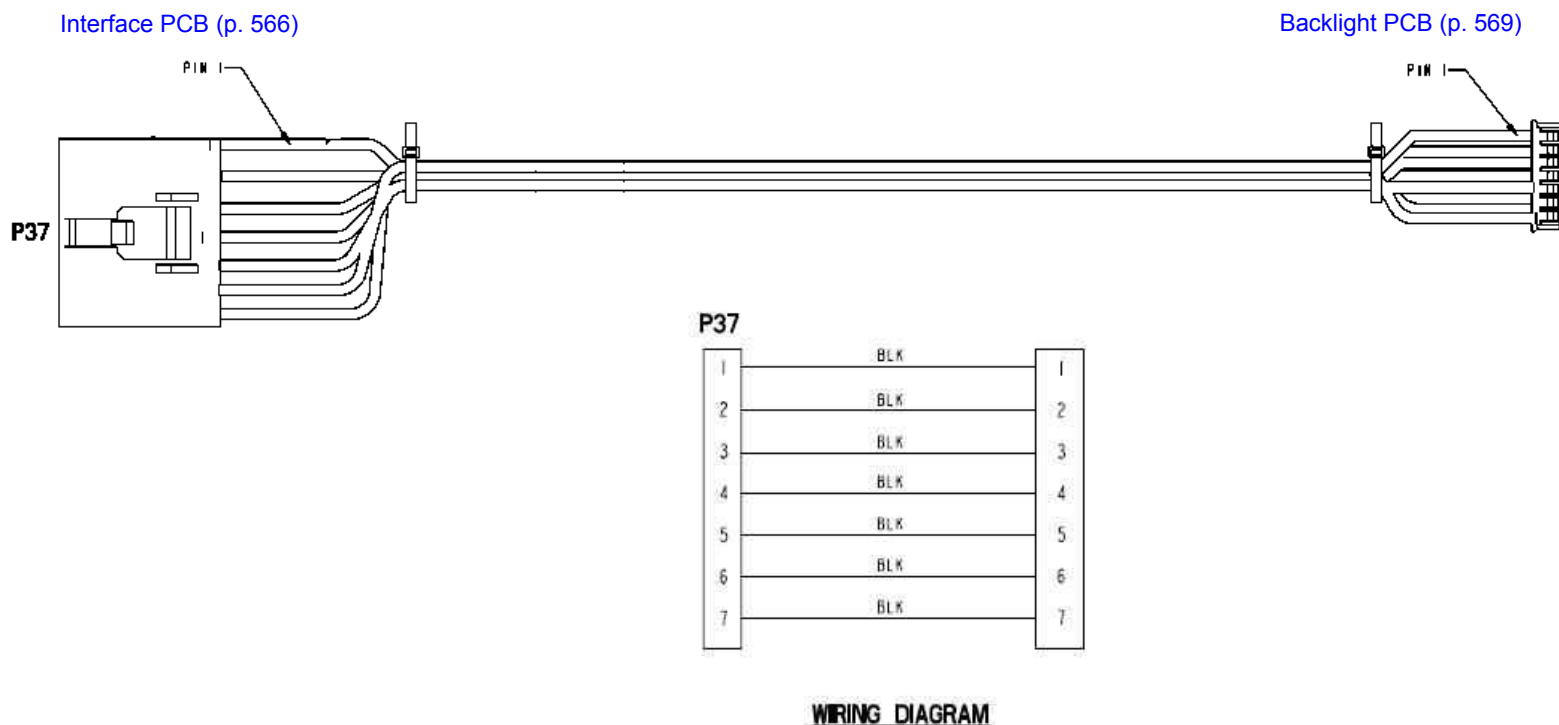

Figure 11.46—Diagram for item W06

### ECG Connector Cable

Refer to [Parameter Bezel Diagrams and Parts List \(p. 512\)](#).  
See MIN 3007991-007 in table for parts information.

System PCB (p. 563)

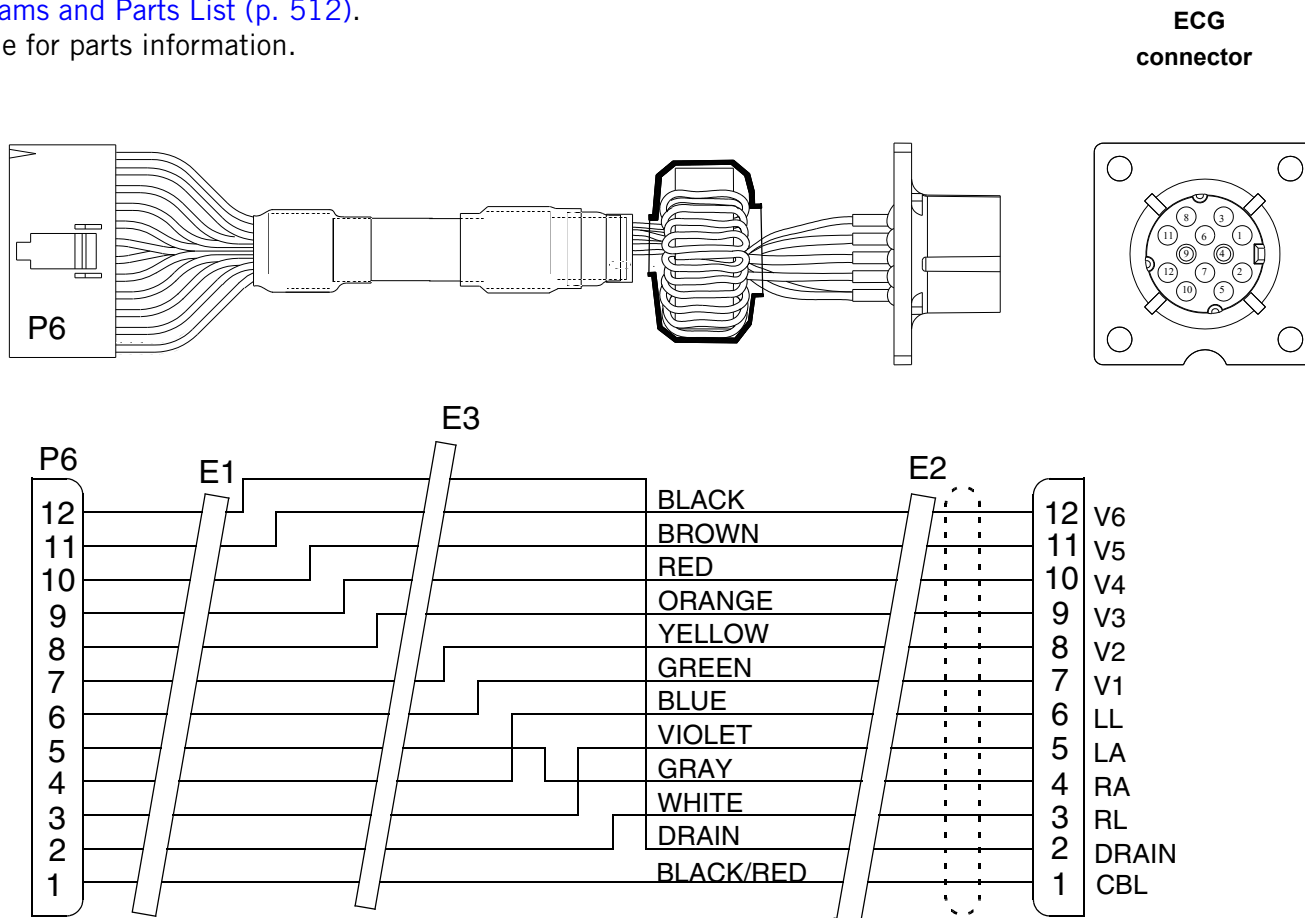

Figure 11.47—Diagram for item W07



### System Connector Cable

Refer to [Figure 11.17: Rear Case view 4 of 7, p. 523](#).

See MIN 3009652-01 in table for part information.

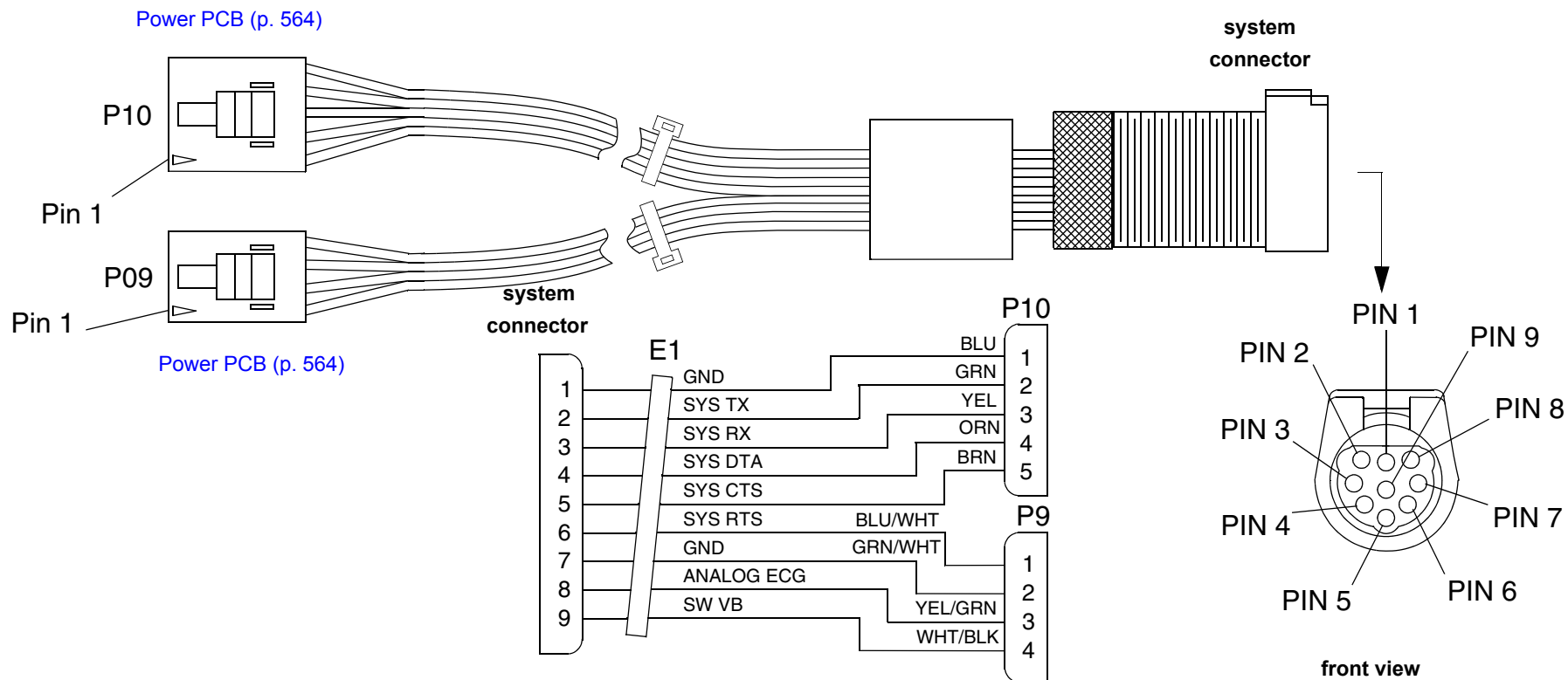

Figure 11.48—Diagram for item W08

### Auxiliary Power Connector Cable (V2)

Refer to [Figure 11.17: Rear Case view 4 of 7, p. 523](#).  
See MIN [3303848-002](#) in table for part information.

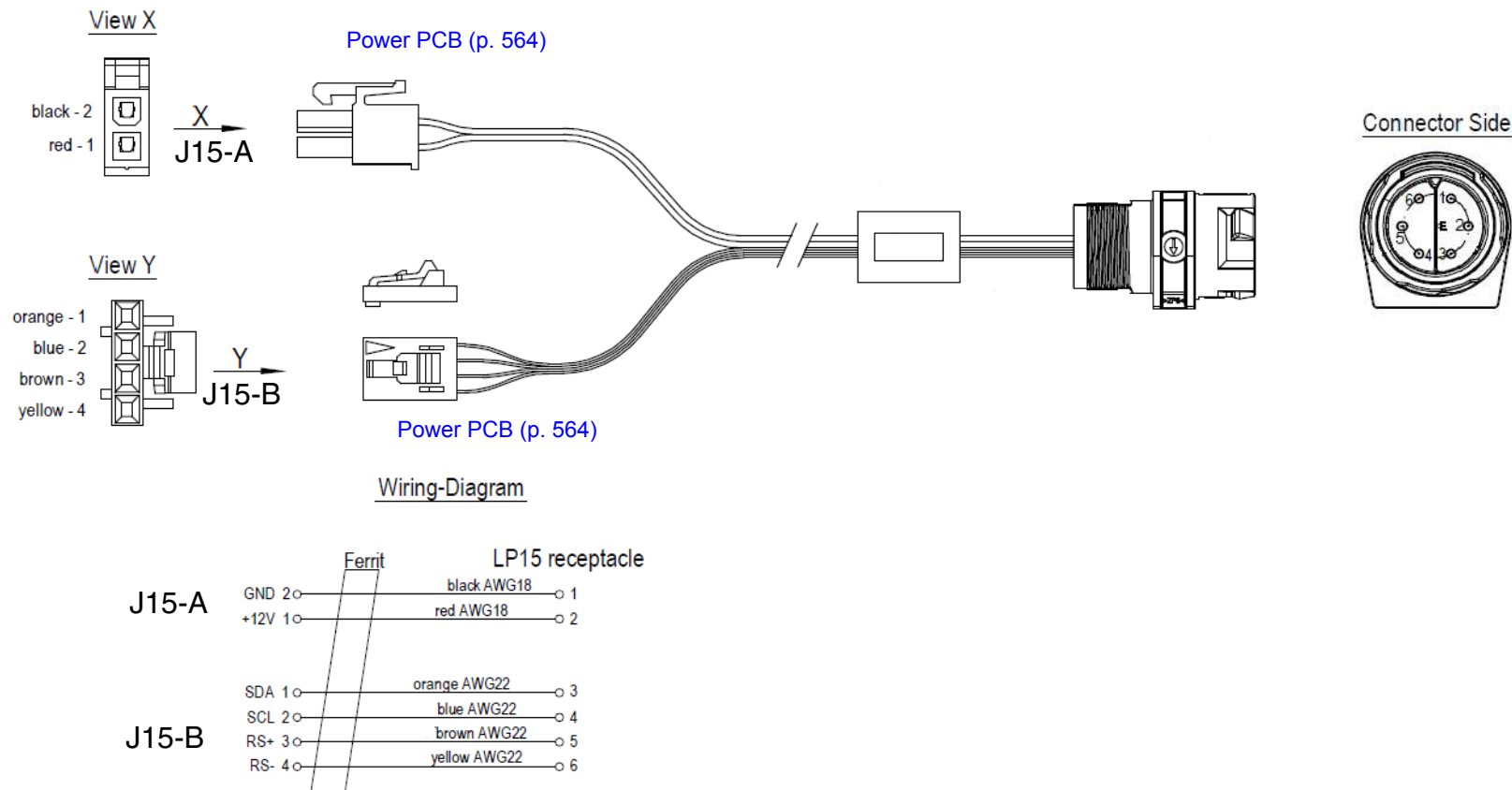
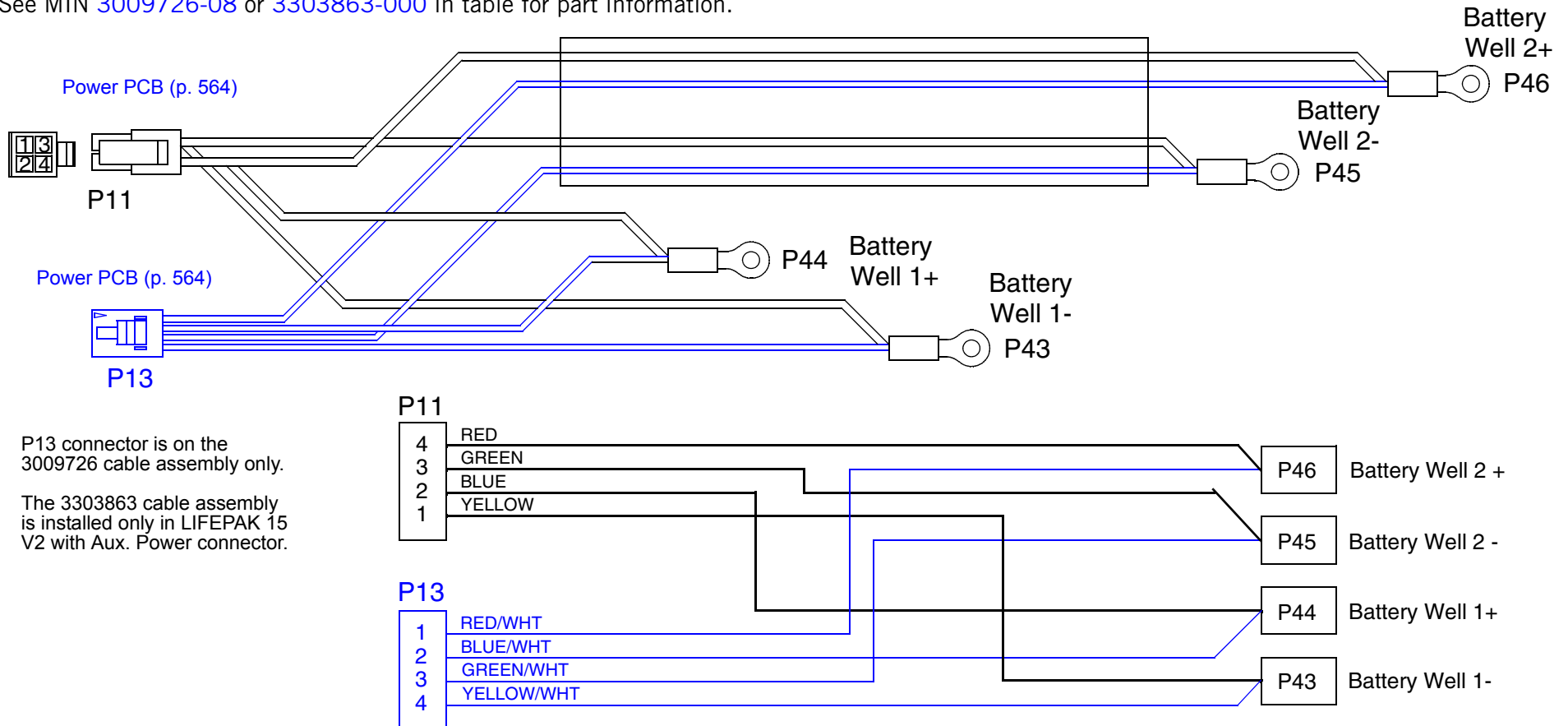

Figure 11.49—Diagram for item W09

### Battery Pins/Power PCB Cable

Refer to [Figure 11.17: Rear Case view 4 of 7, p. 523.](#)  
See MIN 3009726-08 or 3303863-000 in table for part information.



P13 connector is on the 3009726 cable assembly only.

The 3303863 cable assembly is installed only in LIFEPAK 15 V2 with Aux. Power connector.

Figure 11.50—Diagram for item W10

### Therapy Connector Cable

Refer to [Figure 11.5: Front Case parts view 1 of 3, p. 498.](#)  
See MIN [3207044-002](#) in table for part information.

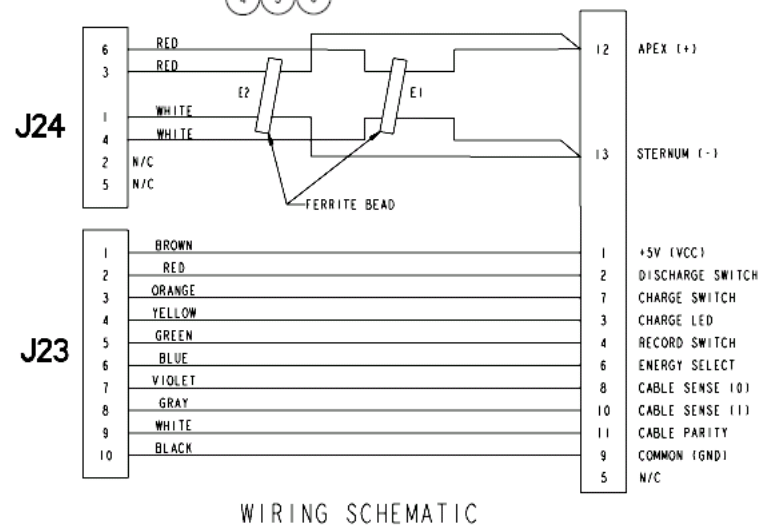
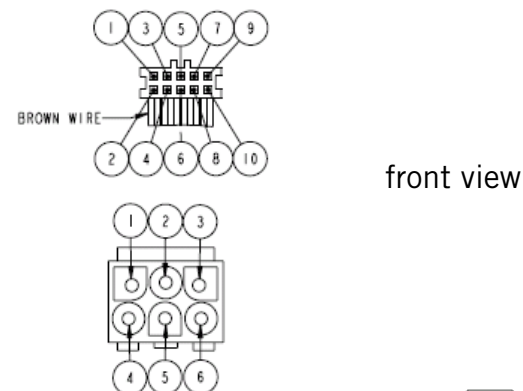
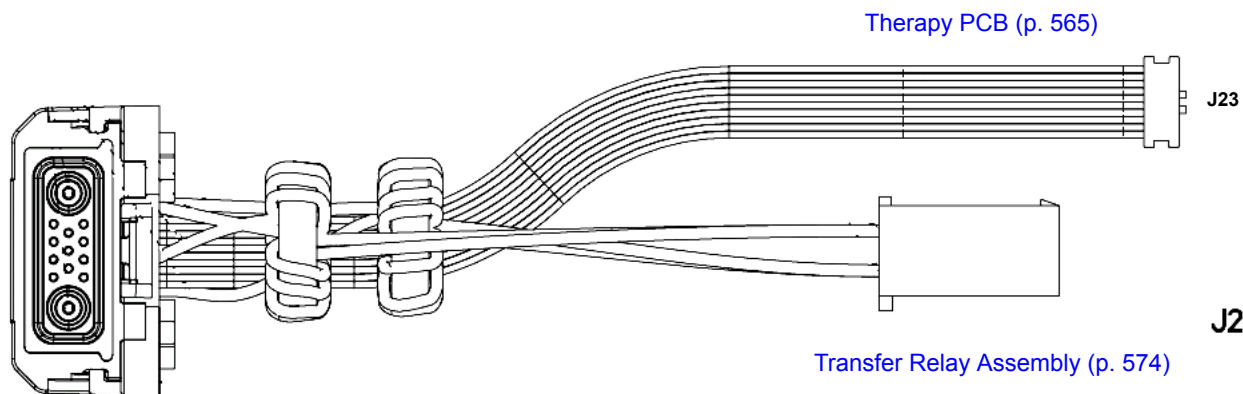

Figure 11.51—Diagram for item W11

### Printer Control Keypad/Interface PCB Cable

Refer to [Figure 11.6: Front Case parts view 2 of 3, p. 499](#).  
See MIN [3206989-000](#) in table for parts information.

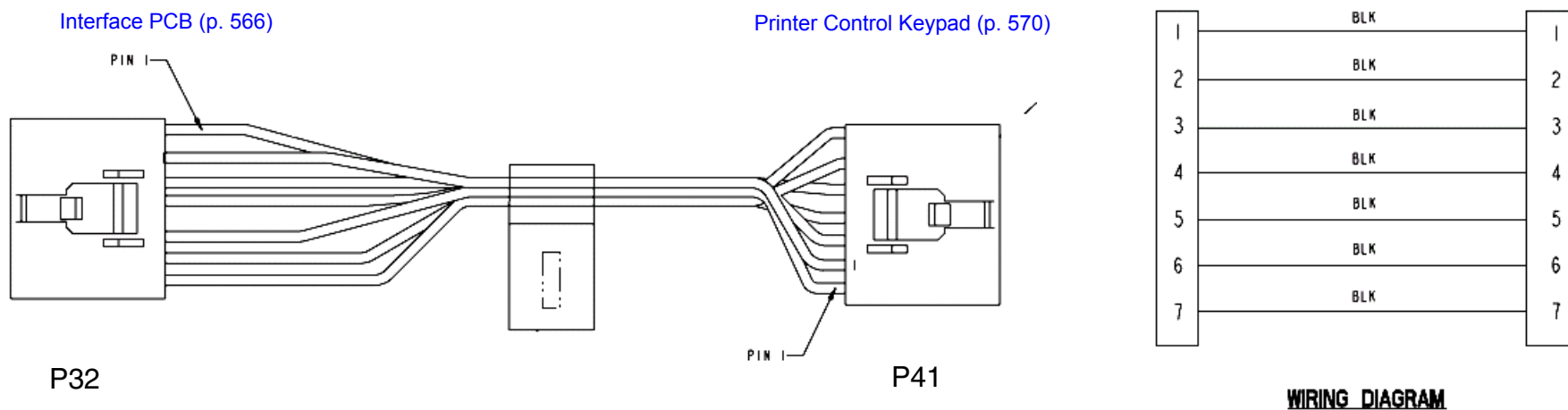

Figure 11.52—Diagram for item W12

### Main Keypad/Interface PCB Cable

Refer to [Figure 11.6: Front Case parts view 2 of 3](#), p. 499.  
See MIN [3207388-001](#) in table for parts information.

Interface PCB (p. 566)

Main Keypad (p. 571)

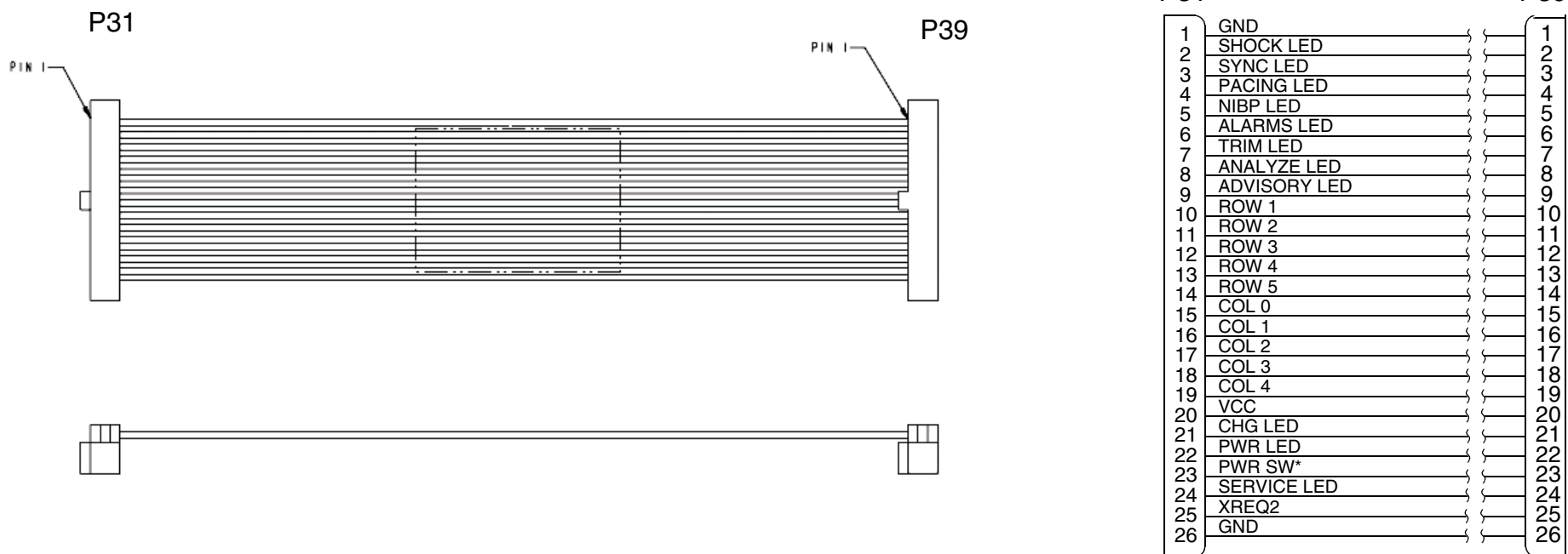
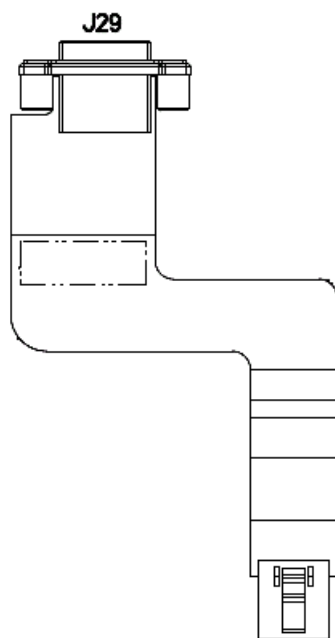

Figure 11.53—Diagram for item W13

### USB Flex Assembly

Refer to [Figure 11.16: Rear Case view 3 of 7, p. 522](#).  
See MIN [3206966-001](#) in table for parts information.



System PCB (p. 563)

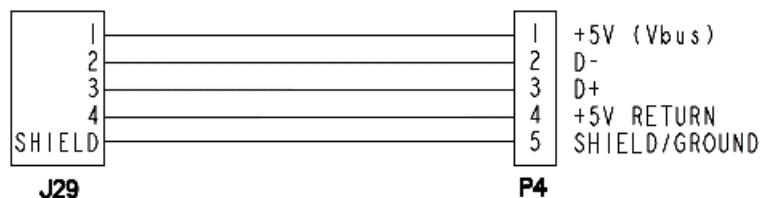

PIN-OUT DIAGRAM

Figure 11.54—Diagram for item W14

### Speed Dial Assembly

Refer to [Figure 11.6: Front Case parts view 2 of 3, p. 499](#).  
See MIN [3011128-002](#) in table for parts information.

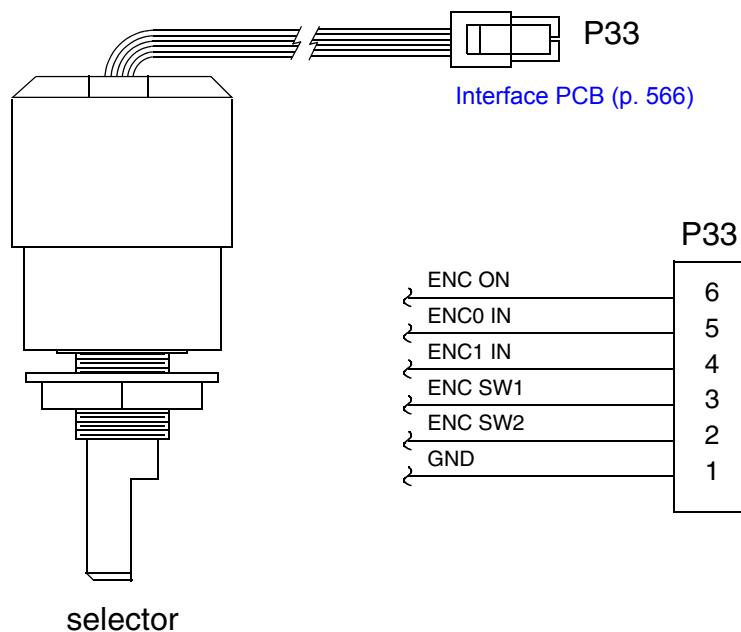

Figure 11.55—Diagram for item W15



### Printer Assembly/Interface PCB Cable

Refer to [Figure 11.7: Front Case parts view 3 of 3, p. 500.](#)  
See MIN [3009724-001](#) in table for parts information.

Printer Assembly (p. 573)

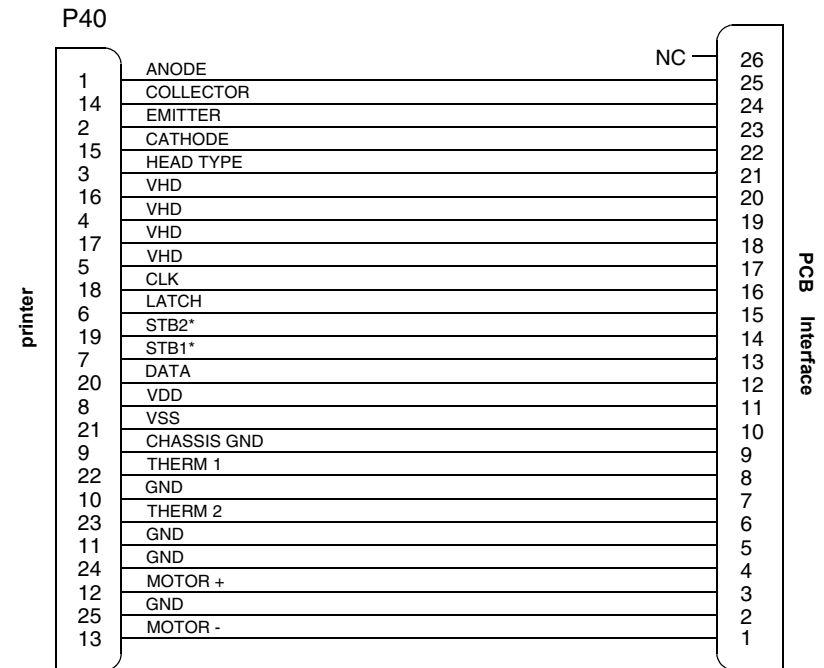
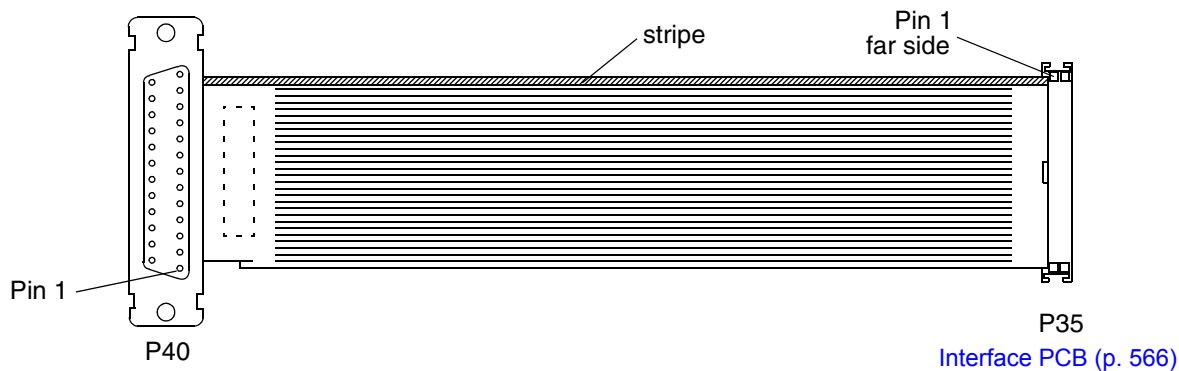

Figure 11.56—Diagram for item W16

### Speaker Assembly

Refer to [Figure 11.6: Front Case parts view 2 of 3, p. 499](#).  
See MIN [3009726-03](#) in table for parts information.

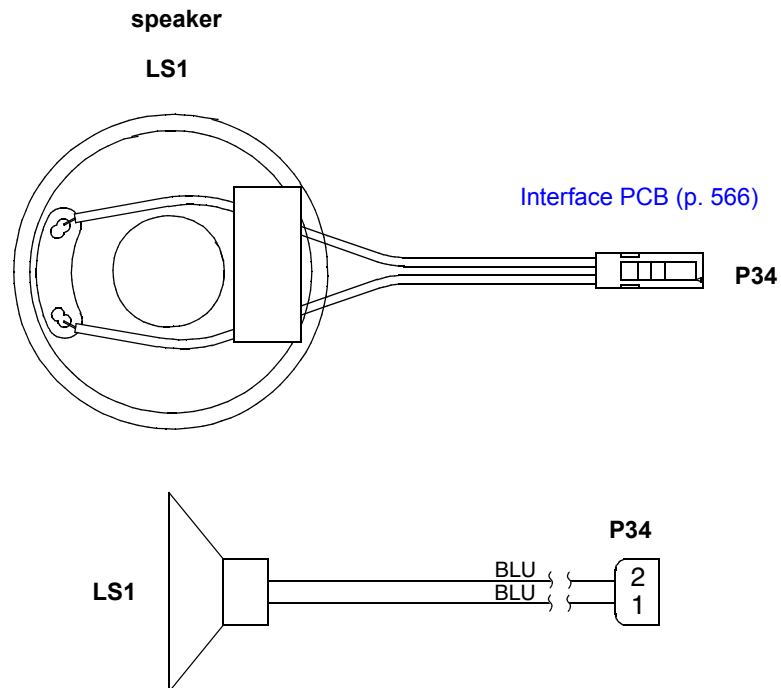

Figure 11.57—Diagram for item W17

### LCD Assembly/Interface PCB Cable

Refer to [Figure 11.6: Front Case parts view 2 of 3, p. 499](#).  
See MIN 3206990-001 in table for parts information.

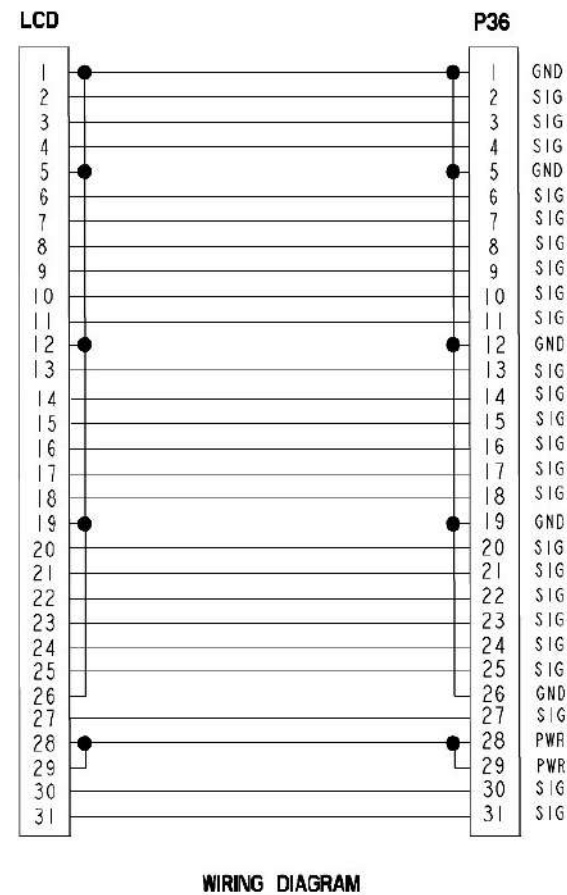
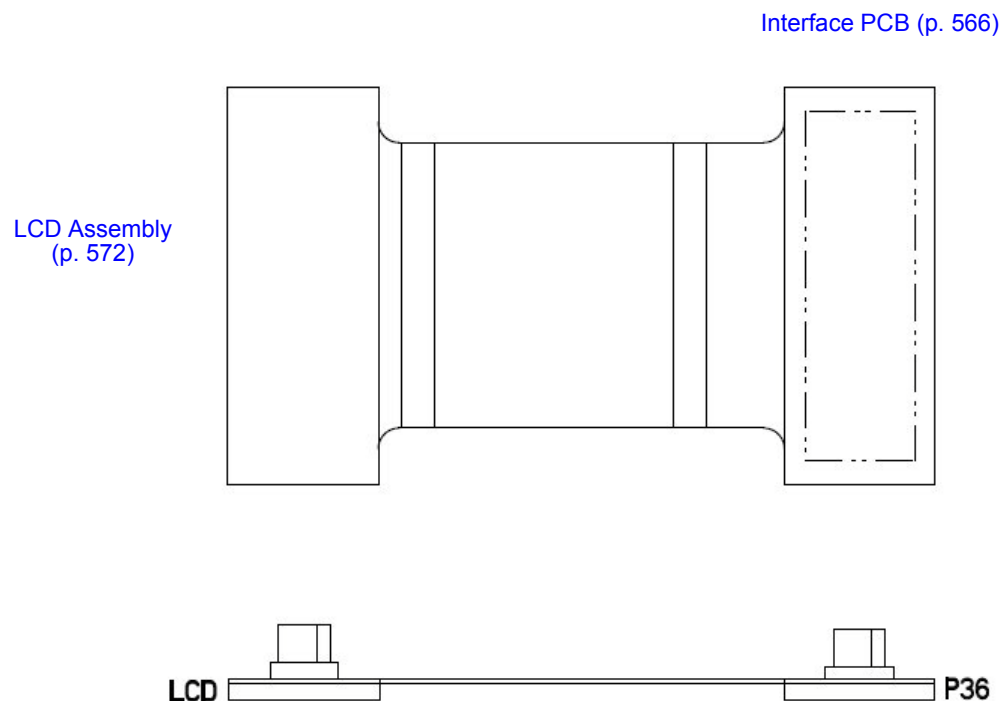

Figure 11.58—Diagram for item W18

### Printer Assembly/Chassis Ground Cable

Refer to [Figure 11.6: Front Case parts view 2 of 3](#), p. 499.  
See MIN [3009726-01](#) in table for parts information.



Figure 11.59—Diagram for item W19

### Biphasic to Therapy PCB Flex Cable

Refer to [Figure 11.20: Rear Case view 7 of 7, p. 526](#).  
See MIN [3011792-005](#) in table for part information.

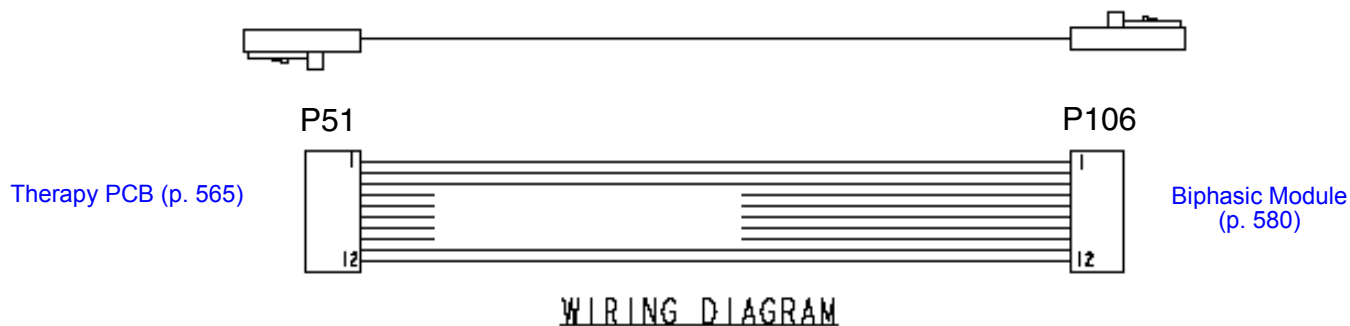
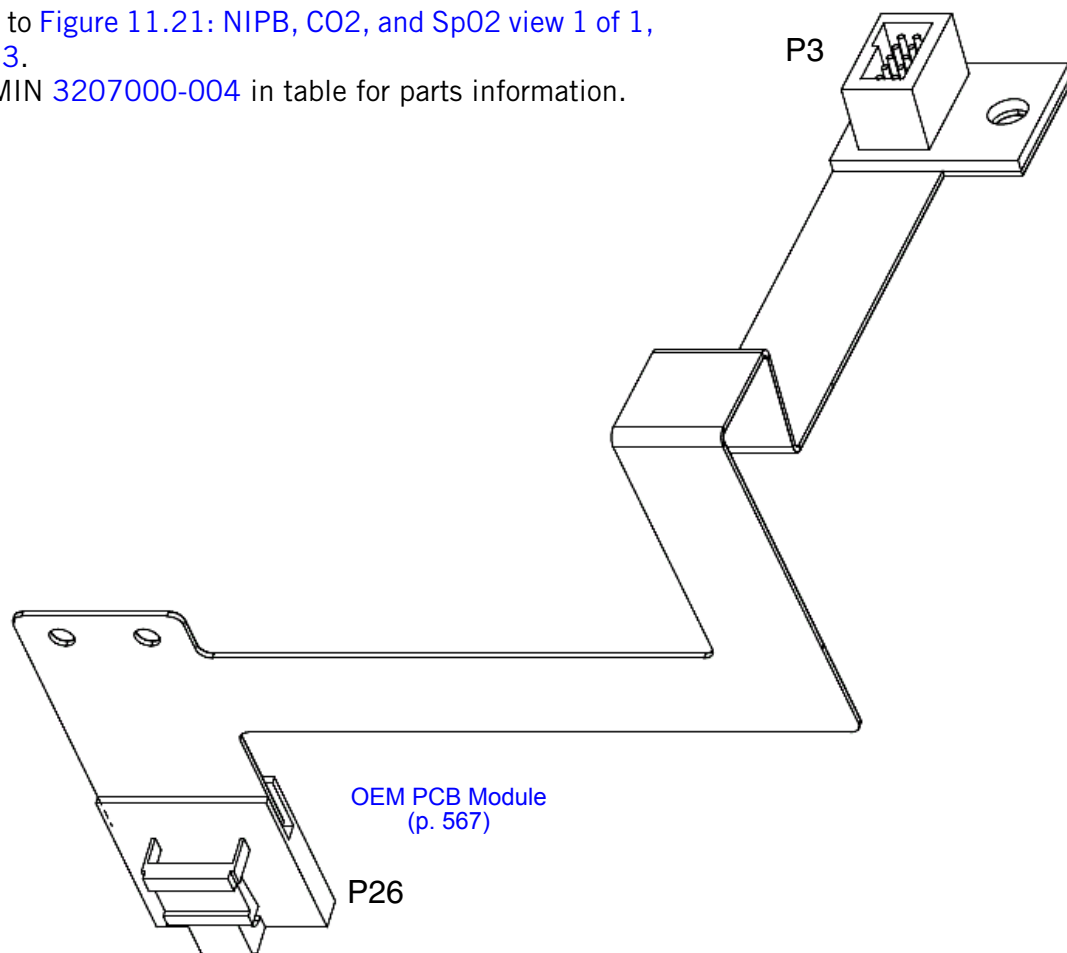

Figure 11.60—Diagram for item W20

### OEM PCB/SpO2 Module Cable

Refer to [Figure 11.21: NIPB, CO2, and SpO2 view 1 of 1, p. 533](#).  
See MIN [3207000-004](#) in table for parts information.



[SpO2 Module \(p. 577\)](#)

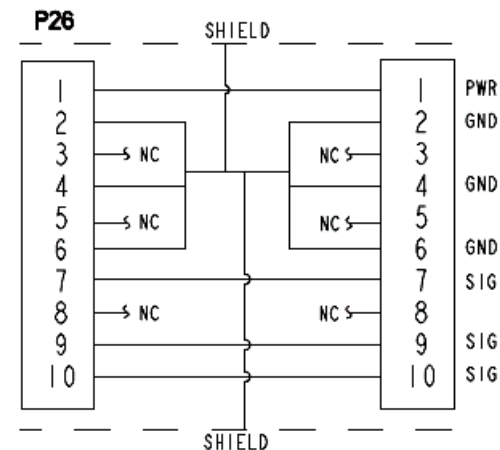

**SCHEMATIC DIAGRAM**

**Figure 11.61—Diagram for item W21**

### SpO2 Connector Cable

Refer to [Parameter Bezel Diagrams and Parts List \(p. 512\)](#) and [NIPB, CO2, and SpO2 view 1 of 1 \(p. 533\)](#)

See MIN [3207000-004](#) in table for parts information.

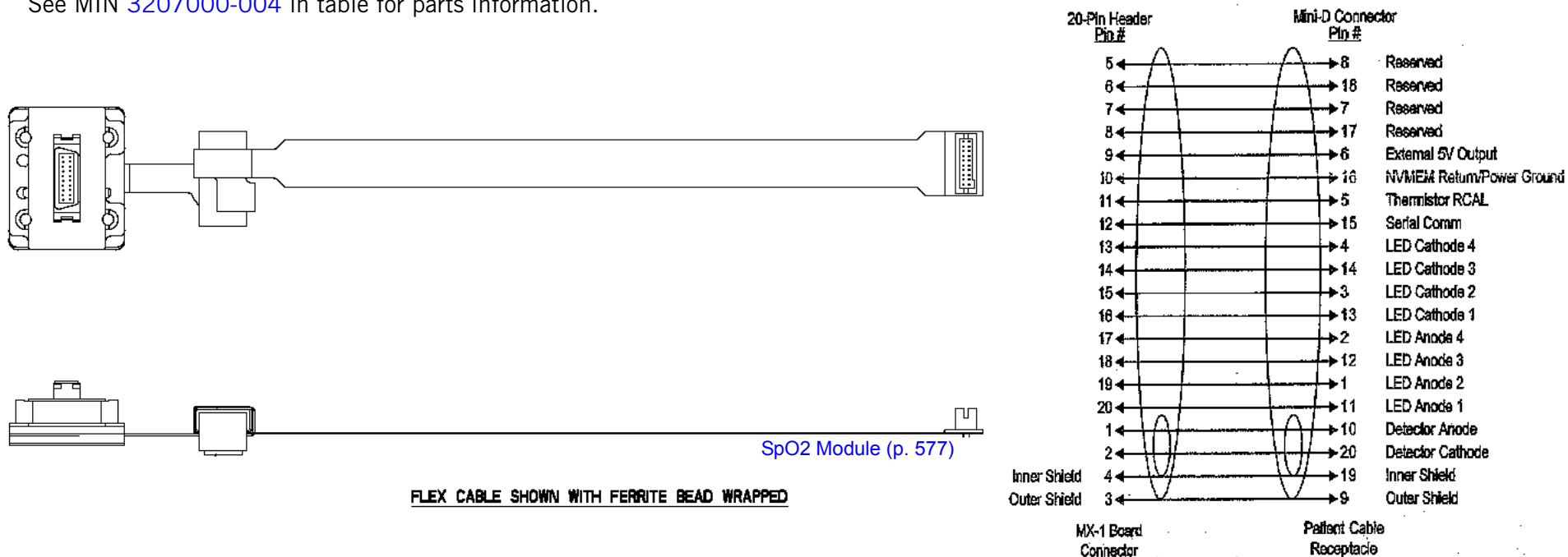
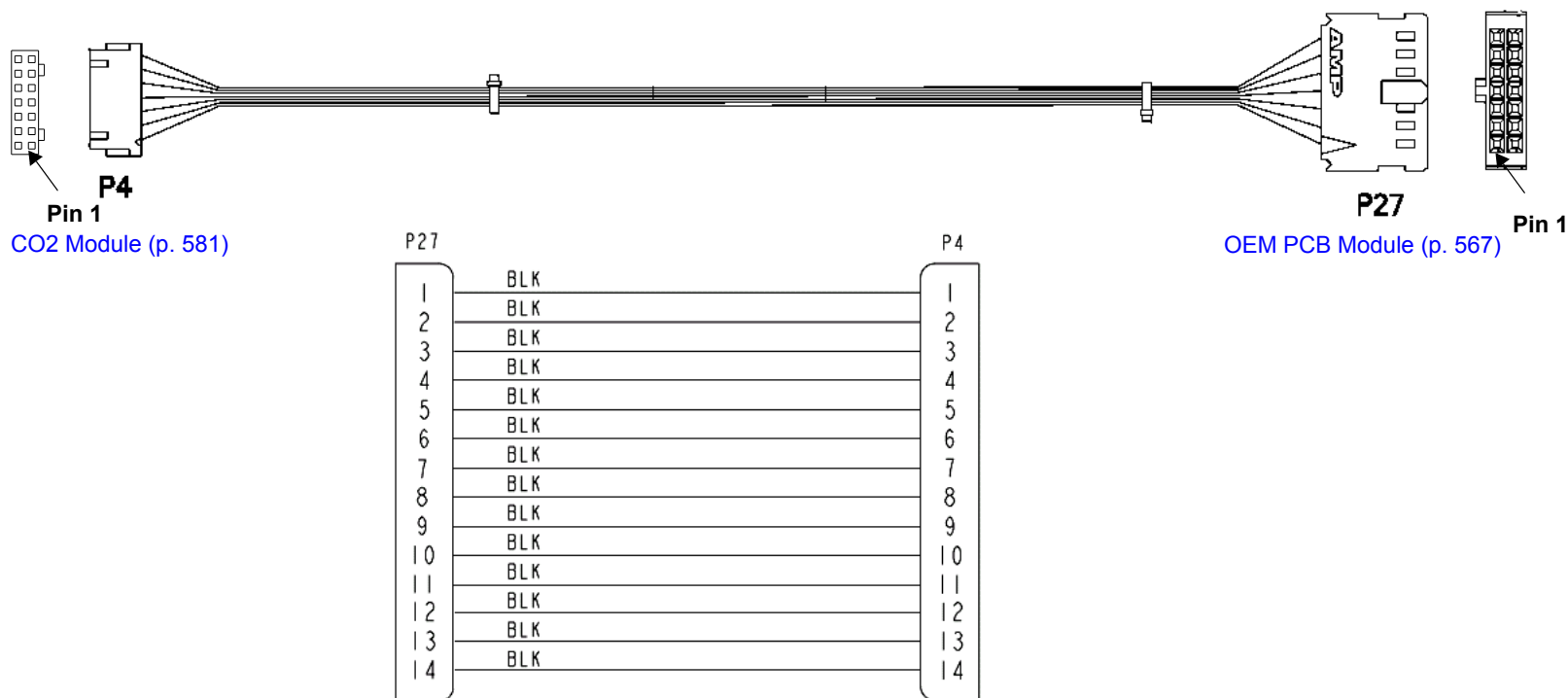

Figure 11.62—Diagram for item W22

### OEM PCB/CO2 Module Cable

Refer to [NIPB, CO2, and SpO2 \(p. 533\)](#).  
See MIN [3206998-002](#) in table for part information.



### WIRING DIAGRAM

Figure 11.63—Diagram for item W26



### OEM PCB/NIBP Module Cable

Refer to [NIPB, CO2, and SpO2 \(p. 533\)](#).  
See MIN [3012181-02](#) in table for part information.

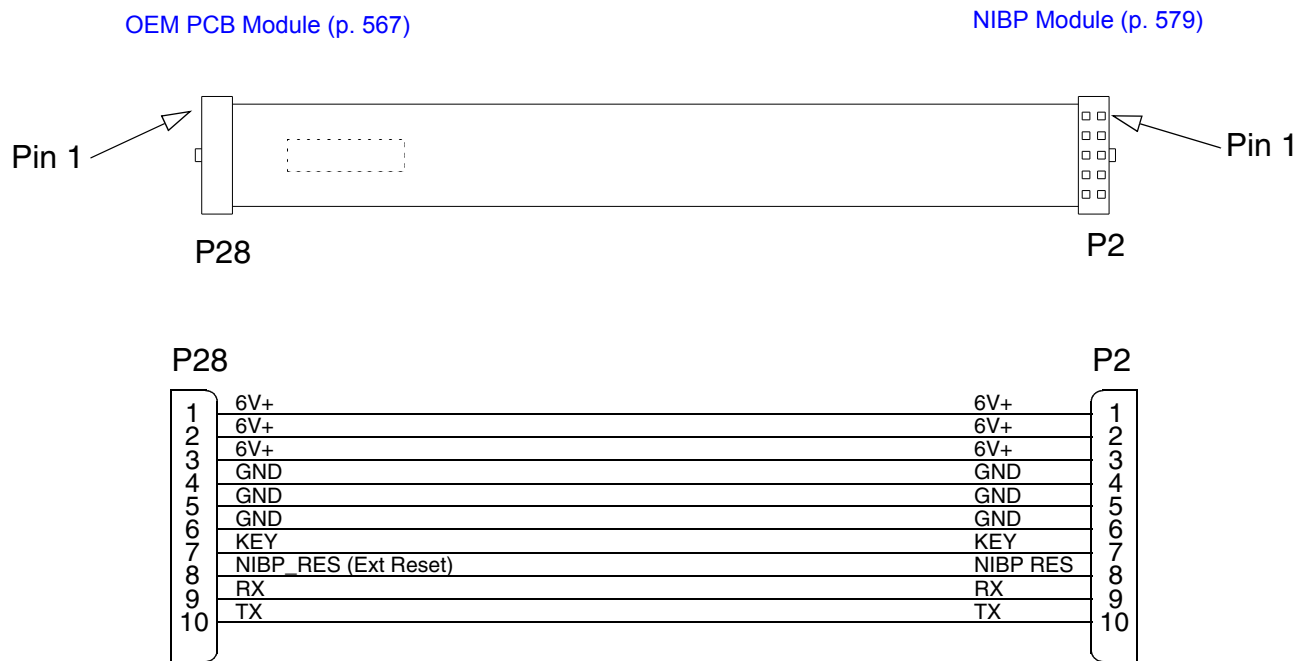

Figure 11.64—Diagram for item W27

### CO2 Inlet Connector Cable

Refer to [Figure 11.11: Parameter Bezel view 2 of 4 \(optional CO2 and NIBP\)](#), p. 513.

See MIN [3012140-008](#) in table for part information.

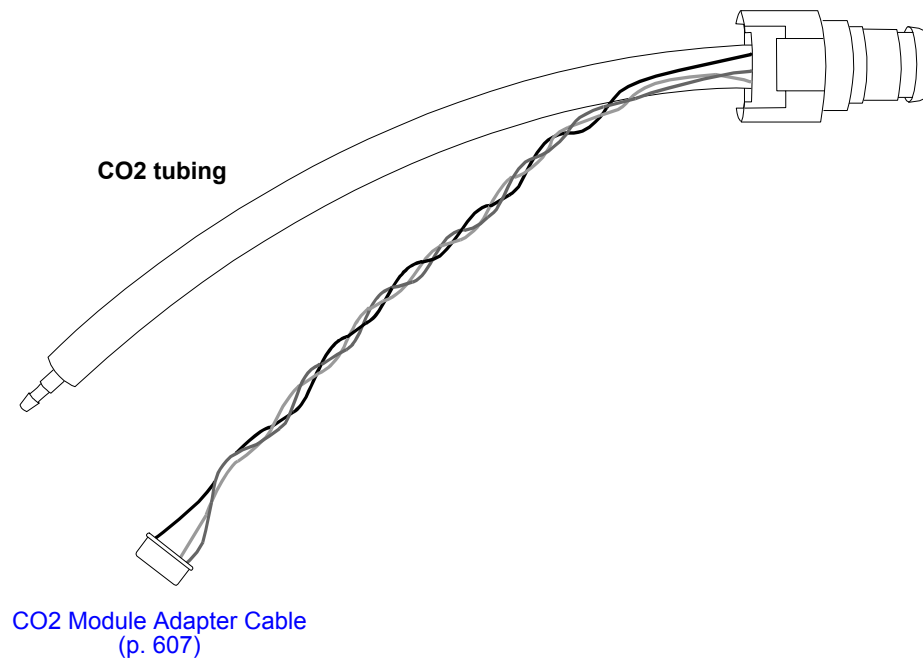

Figure 11.65—Diagram for item W28

### CO2 Module Adapter Cable

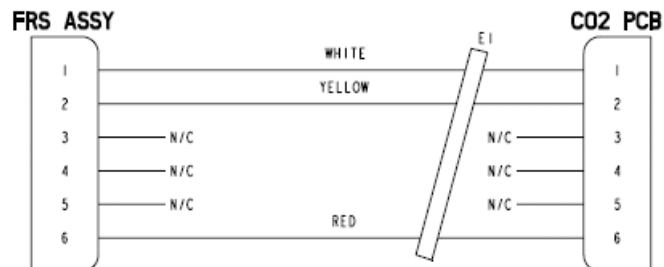
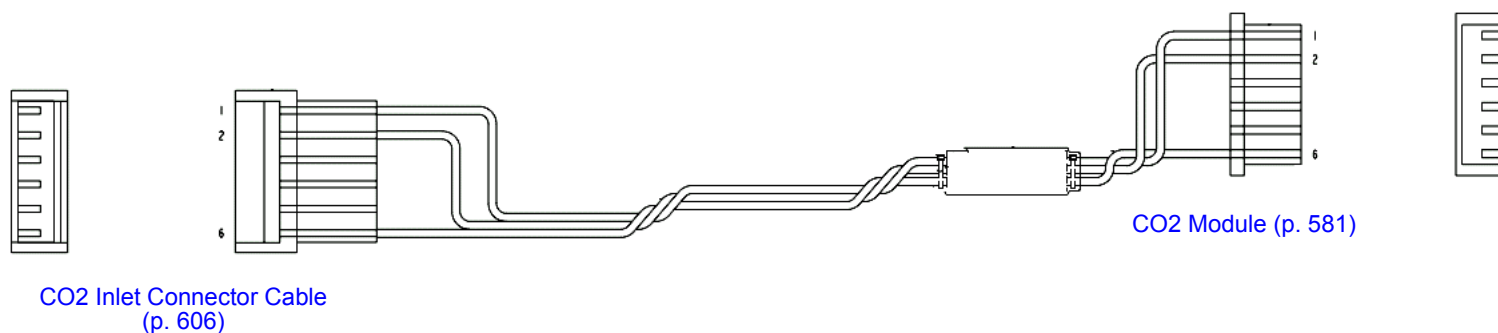

Figure 11.66—Diagram for item W30

### Invasive Pressure Assembly

Refer to [Figure 11.12: Parameter Bezel view 3 of 4](#)  
(optional invasive pressure), p. 514.

See MIN 3200466-01 in table for parts information.

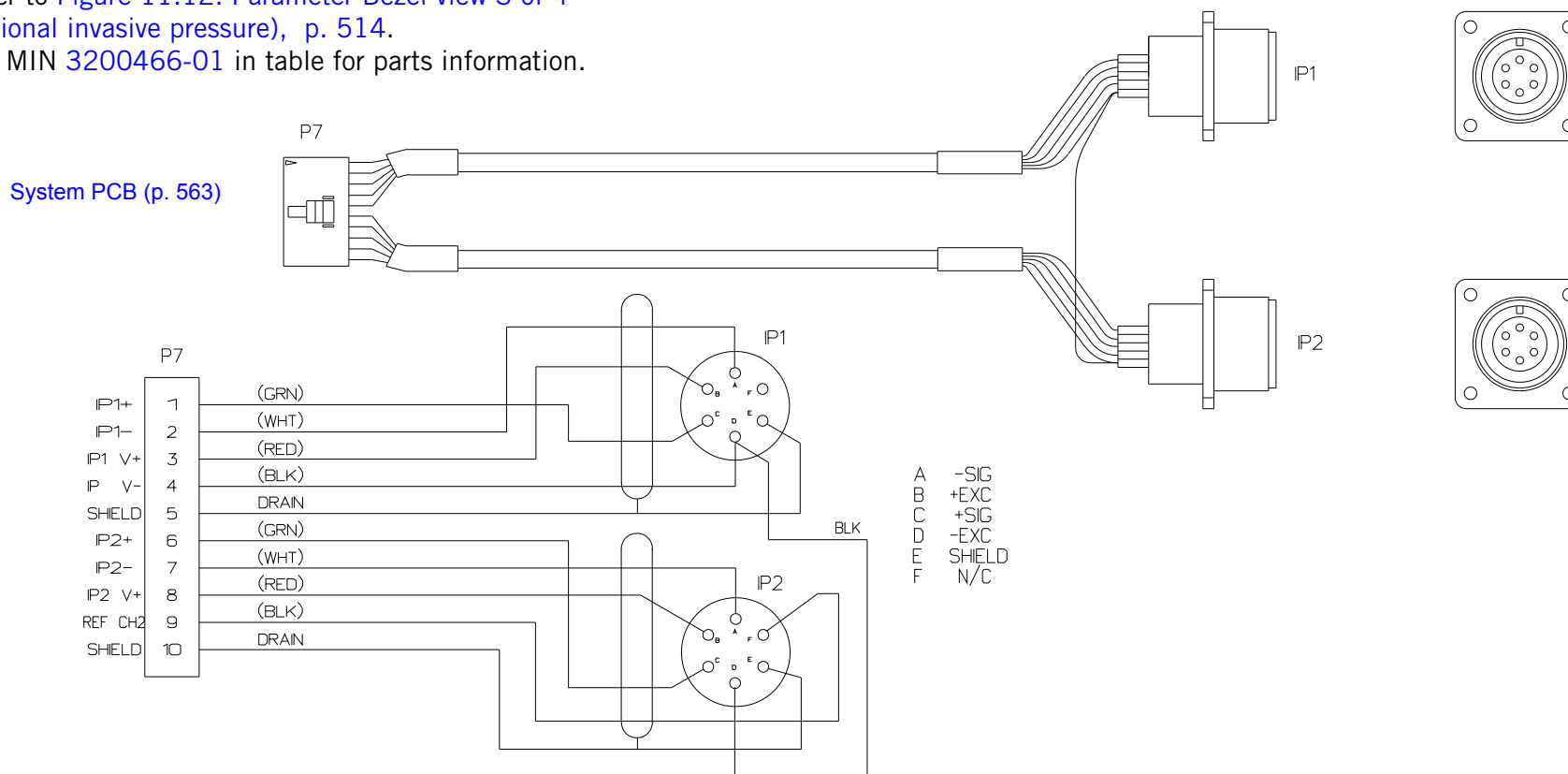

Figure 11.67—Diagram for item W33

### Temperature Connector Cable Assembly

Refer to [Figure 11.13: Parameter Bezel view 4 of 4](#) (optional temperature cable assembly), p. 515.  
See MIN [3303936-001](#) in table for parts information.

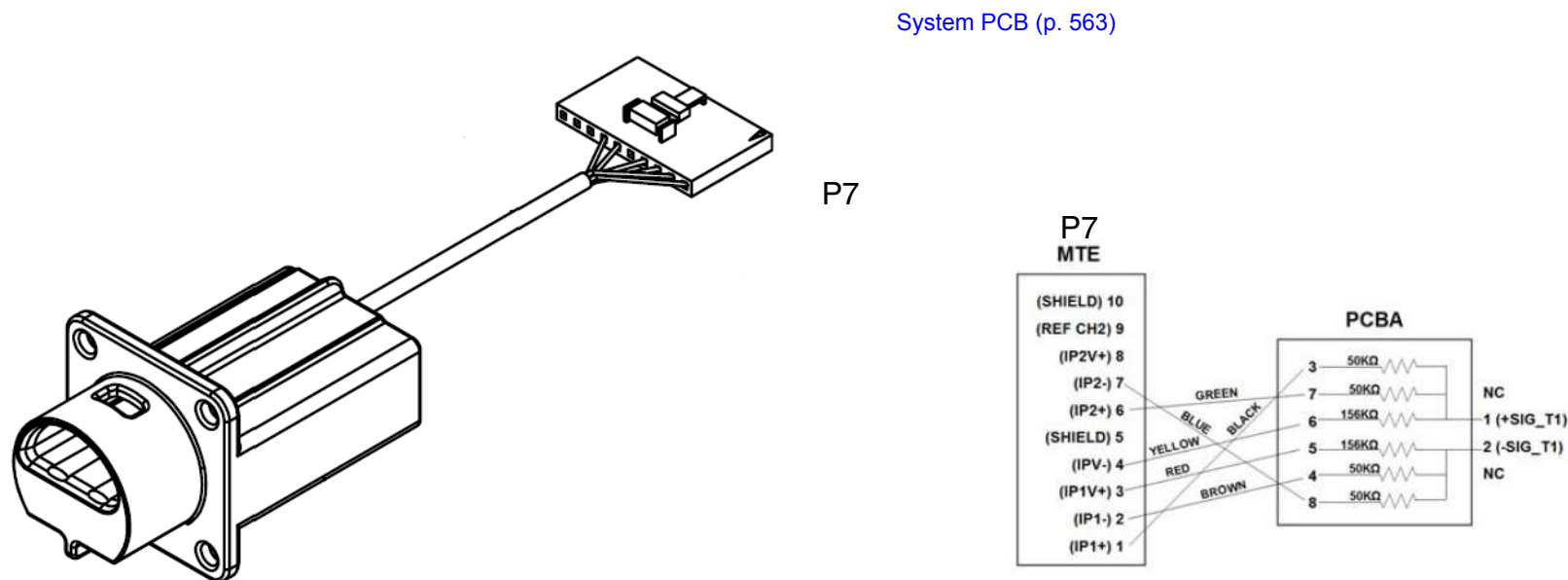

Figure 11.68—Diagram for item W35

### Repair Kits

The repair kits include components that support a particular replacement activity.

Due to the need for special tooling and processes, the front and rear case repair kits come partially assembled from the factory.

**Table 11.16—Repair Kits List**

Repair Kit
<a href="#">NIBP Module Repair Kit (MIN 3305431-000) (p. 612)</a>
<a href="#">Invasive Pressure Connector Repair Kit (MIN 3305431-001) (p. 613)</a>
<a href="#">CO2 Module Repair Kit (MIN 3305431-002) (p. 614)</a>
<a href="#">OEM PCBA Repair Kit, V1 (MIN 3305431-004) (p. 615)</a>
<a href="#">Interface PCBA Repair Kit, V1 (MIN 3305431-005) (p. 616)</a>
<a href="#">Power PCBA Repair Kit, V1 (MIN 3305431-006) (p. 617)</a>
<a href="#">System PCBA Repair Kit, V1 (MIN 3305431-007) (p. 618)</a>
<a href="#">Therapy PCBA Repair Kit (MIN 3305431-008) (p. 619)</a>
<a href="#">Therapy Connector Repair Kit (MIN 3305431-009) (p. 620)</a>
<a href="#">ECG Connector Repair Kit (MIN 3305431-010) (p. 620)</a>
<a href="#">Biphasic Module Repair Kit (MIN 3305431-011) (p. 621)</a>
<a href="#">Backlight Inverter Repair Kit (MIN 3305431-012) (p. 622)</a>
<a href="#">Display Repair Kit (MIN 3305431-013) (p. 622)</a>

**Table 11.16—Repair Kits List (Continued)**

Repair Kit
<a href="#">CO2 Connector Repair Kit (MIN 3305431-014) (p. 623)</a>
<a href="#">Internal Hardware Repair Kit (MIN 3305431-015) (p. 624)</a>
<a href="#">External Hardware Repair Kit (MIN 3305431-016) (p. 624)</a>
<a href="#">Paddle Retainer Repair Kit (MIN 3305431-017) (p. 625)</a>
<a href="#">Display Shield Repair Kit (MIN 3305431-018) (p. 625)</a>
<a href="#">Guard &amp; Feet Repair Kit (MIN 3305431-019) (p. 626)</a>
<a href="#">Handle Repair Kit (MIN 3305431-020) (p. 626)</a>
<a href="#">NIBP Connector Repair Kit (MIN 3305431-022) (p. 627)</a>
<a href="#">Front Case Repair Kit (MIN 3305431-023) (p. 628)</a>
<a href="#">Rear Case Repair Kit (MIN 3305431-024) (p. 629)</a>
<a href="#">MASIMO SpO2 Module Repair Kit (MIN 3305431-025) (p. 630)</a>
<a href="#">MASIMO SpO2 Panel Mount Cable Repair Kit (MIN 3305431-026) (p. 631)</a>
<a href="#">Temperature Cable Repair Kit (MIN 3305431-027) (p. 632)</a>
<a href="#">OEM PCBA Repair Kit, V2 (MIN 3305431-028) (p. 633)</a>
<a href="#">Interface PCBA Repair Kit, V2 (MIN 3305431-029) (p. 634)</a>
<a href="#">Power PCBA Repair Kit, V2 (MIN 3305431-030) (p. 635)</a>
<a href="#">System PCBA Repair Kit (MIN 3305431-031) (p. 636)</a>

### NIBP Module Repair Kit (MIN 3305431-000)

Table 11.17—NIBP Module Repair Kit Parts

MIN	Description	Notes
3206268	MODULE, NIBP, NONINVASIVE BP, ND+ ROHS	
202253-760	SCREW-M, PH, NYLOK, CS, 4-40, .250L	
202253-761	SCREW-M, CS, Z, PH, NYLOCK, 4-40 X .312L	
3207337-312	SCREW-MACH, PNH, PHH, NYLOCK, 4-40, 0.312L, WSHR, CS, ZN	
3010805-000	SOCKET RETAINER CLIP - 10 PIN	
3207361-375	SCREW, CAP SCH, TORX, 6-32 X .375L, SS	
201407-069	SCREW- 6-32 X .375	
202253-763	SCREW-M PH, NYLOK 4-40 X .437	



### Invasive Pressure Connector Repair Kit (MIN 3305431-001)

Table 11.18—IP Connector Repair Kit Parts List

MIN	Description	Notes
3200466	WIRE HARNESS-INVASIVE PRESSURE 1 / 2	
3007998	GASKET-CONNECTOR, INVASIVE PRESSURE	
3207337-312	SCREW-MACH, PNH, PHH, NYLOCK, 4-40, 0.312L, WSHR, CS, ZN	
3207361-375	SCREW, CAP SCH, TORX, 6-32 X .375L, SS	
201407-069	SCREW- 6-32 X .375	
202253-763	SCREW-M PH, NYLOK 4-40 X .437	

### C02 Module Repair Kit (MIN 3305431-002)

Table 11.19—C02 Module Parts List

MIN	Description	Notes
3012140	MODULE, CO2, MINI	
202253-760	SCREW-M, PH, NYLOK, CS, 4-40, .250L	
202253-761	SCREW-M, CS, Z, PH, NYLOCK, 4-40 X .312L	
3207337-312	SCREW-MACH, PNH, PHH, NYLOCK, 4-40, 0.312L, WSHR, CS, ZN	
3010805-000	SOCKET RETAINER CLIP - 10 PIN	
3207361-375	SCREW, CAP SCH, TORX, 6-32 X .375L, SS	
201407-069	SCREW- 6-32 X .375	
202253-763	SCREW-M PH, NYLOK 4-40 X .437	

### OEM PCBA Repair Kit, V1 (MIN 3305431-004)

Table 11.20—OEM PCBA Repair Kit Parts List

MIN	Description	Notes
3206813	PCB ASSY - OEM, LIFEPAK15	
202253-761	SCREW-M,CS, Z, PH, NYLOCK, 4-40 X .312L	
3207337-312	SCREW-MACH, PNH, PHH, NYLOCK, 4-40, 0.312L , WSHR, CS, ZN	
3010805-000	SOCKET RETAINER CLIP - 10 PIN	
3207361-375	SCREW, CAP SCH, TORX, 6-32 X .375L, SS	
201407-069	SCREW- 6-32 X .375	
202253-763	SCREW-M PH, NYLOK 4-40 X .437	
3206991	CABLE ASSY—FLEX, SYSTEM PCB/INTERFACE PCB	

### Interface PCBA Repair Kit, V1 (MIN 3305431-005)

Table 11.21—Interface PCBA Repair Kit Parts List

MIN	Description	Notes
3206815	PCB ASSY - INTERFACE, LIFEPAK15	
202253-761	SCREW-M, CS, Z, PH, NYLOCK, 4-40 X .312L	
3207361-375	SCREW, CAP SCH, TORX, 6-32 X .375L, SS	
201407-069	SCREW- 6-32 X .375	
202253-763	SCREW-M PH, NYLOK 4-40 X .437	

### Power PCBA Repair Kit, V1 (MIN 3305431-006)

Table 11.22—Power PCBA Repair Kit Parts List

MIN	Description	Notes
3206749	PCB ASSY - POWER, LIFEPAK15	
202253-761	SCREW-M, CS, Z, PH, NYLOCK, 4-40 X .312L	
3207337-312	SCREW-MACH, PNH, PHH, NYLOCK, 4-40, 0.312L, WSHR, CS, ZN	
3010805-000	SOCKET RETAINER CLIP - 10 PIN	
3207361-375	SCREW, CAP SCH, TORX, 6-32 X .375L, SS	
201407-069	SCREW- 6-32 X .375	
202253-763	SCREW-M PH, NYLOK 4-40 X .437	

### System PCBA Repair Kit, V1 (MIN 3305431-007)

Table 11.23—System PCBA Repair Kit Parts List

MIN	Description	Notes
3206834	PCB ASSY - SYSTEM, LIFEPAK15	
3009878	CONN-HDR, SQUARE PIN DUAL ROW, 30 PIN	
3011630-00	SPACER-PCB	
202253-761	SCREW-M, CS, Z, PH, NYLOCK, 4-40 X .312L	
3207337-312	SCREW-MACH, PNH, PHH, NYLOCK, 4-40, 0.312L, WSHR, CS, ZN	
3010805-000	SOCKET RETAINER CLIP - 10 PIN	
3207361-375	SCREW, CAP SCH, TORX, 6-32 X .375L, SS	
201407-069	SCREW- 6-32 X .375	
202253-763	SCREW-M PH, NYLOK 4-40 X .437	
3011980-00	LABEL, SHOCK HAZARD	
3011629	INSERT—HEX, LP12	

### Therapy PCBA Repair Kit (MIN 3305431-008)

Table 11.24—Therapy PCBA Repair Kit Parts List

MIN	Description	Notes
3306311	PCB ASSY - THERAPY, LIFEPAK15	
3011629-00	INSERT-HEX,LIFEPAK15	
202253-550	SCREW-PH, NYLOCK, PHIL, SS, #4-40 X 1.125L	
202253-761	SCREW-M,CS,Z,PH, NYLOCK, 4-40 X .312L	
3207337-312	SCREW-MACH, PNH, PHH, NYLOCK, 4-40, 0.312L, WSHR, CS, ZN	
3010805-000	SOCKET RETAINER CLIP - 10 PIN	
3207361-375	SCREW, CAP SCH, TORX, 6-32 X .375L, SS	
201407-069	SCREW- 6-32 X .375	
202253-763	SCREW-M PH, NYLOK 4-40 X .437	
3011630	SPACER—PCB, LP12	

### Therapy Connector Repair Kit (MIN 3305431-009)

Table 11.25—Therapy Connector Repair Kit Parts List

MIN	Description	Notes
3207044	THERAPY CONN	
3207701	GASKET	
3207361-375	SCREW, CAP SCH, TORX, 6-32 X .375L, SS	
201407-069	SCREW- 6-32 X .375	

### ECG Connector Repair Kit (MIN 3305431-010)

Table 11.26—Hypertronics ECG Connector Repair Kit Parts List

MIN	Description	Notes
3007991	ECG CABLE	
805915	GASKET	
3207361-375	SCREW, CAP SCH, TORX, 6-32 X .375L, SS	
201407-069	SCREW- 6-32 X .375	
202253-763	SCREW-M PH, NYLOK 4-40 X .437	



### Biphasic Module Repair Kit (MIN 3305431-011)

Table 11.27—Biphasic Module Repair Kit Parts List

MIN	Description	Notes
3010178	PCB ASSY - BIPHASIC MODULE, LIFEPAK15	
200536-001	CABLE TIES, SM	
202253-761	SCREW-M, CS, Z, PH, NYLOCK, 4-40 X .312L	
3207337-312	SCREW-MACH, PNH, PHH, NYLOCK, 4-40, 0.312L, WSHR, CS, ZN	
3207361-375	SCREW, CAP SCH, TORX, 6-32 X .375L, SS	
201407-069	SCREW- 6-32 X .375	
202253-763	SCREW-M PH, NYLOK 4-40 X .437	

### Backlight Inverter Repair Kit (MIN 3305431-012)

Table 11.28—Backlight Inverter Repair Kit Parts List

MIN	Description	Notes
3207933	BACKLIGHT	
202253-761	SCREW-M, CS, Z, PH, NYLOCK, 4-40 X .312L	
3207361-375	SCREW, CAP SCH, TORX, 6-32 X .375L, SS	
201407-069	SCREW- 6-32 X .375	
202253-763	SCREW-M PH, NYLOK 4-40 X .437	

### Display Repair Kit (MIN 3305431-013)

Table 11.29—Display Repair Kit Parts List

MIN	Description	Notes
3203221	DISPLAY	
202253-764	SCREW, MACHINE, PANHEAD, NYLOK, 4-40 X .500	
202253-761	SCREW-M, CS, Z, PH, NYLOK, 4-40 X .312L	
3207361-375	SCREW, CAP SCH, TORX, 6-32 X .375L, SS	
201407-069	SCREW- 6-32 X .375	
202253-763	SCREW-M PH, NYLOK 4-40 X .437	

### CO2 Connector Repair Kit (MIN 3305431-014)

Table 11.30—CO2 Connector Repair Kit Parts List

MIN	Description	Notes
3012140-008	FRS ASSEMBLY-CO2, MINI-MODULE, LIFEPAK15	
3012121	RETAINER-CO2 CONN	
3007997	SEAL-CO2 CONNECTOR	
3012119	ADAPTER-CO2 CONNECTOR	
202253-732	SCREW-MACH, NYLOK, PNH, PHH, 2-56 X .500, CS, ZN	
3012120	CO2 CONNECTOR COVER	
3207361-375	SCREW, CAP SCH, TORX, 6-32 X .375L, SS	
201407-069	SCREW- 6-32 X .375	
202253-763	SCREW-M PH, NYLOK 4-40 X .437	

### Internal Hardware Repair Kit (MIN 3305431-015)

Table 11.31—Internal Hardware Repair Kit Parts List

MIN	Description	Notes
202253-761	SCREW-M, CS, Z, PH, NYLOCK, 4-40 X .312L	
3207337-312	SCREW-MACH, PNH, PHH, NYLOCK, 4-40, 0.312L, WSHR, CS, ZN	
3010805-000	SOCKET RETAINER CLIP - 10 PIN	

### External Hardware Repair Kit (MIN 3305431-016)

Table 11.32—External Hardware Repair Kit Parts List

MIN	Description	Notes
3207361-375	SCREW, CAP SCH, TORX, 6-32 X .375L, SS	
201407-069	SCREW- 6-32 X .375	
202253-763	SCREW-M PH, NYLOK 4-40 X .437	

### Paddle Retainer Repair Kit (MIN 3305431-017)

Table 11.33—Paddle Retainer Repair Kit Parts List

MIN	Description	Notes
3006766	COVER-LATCH, PADDLE	
201407-069	SCREW- 6-32 X .375	
3207318	LABEL SET, ENGLISH	

### Display Shield Repair Kit (MIN 3305431-018)

Table 11.34—Display Shield Repair Kit Parts List

MIN	Description	Notes*
3305427-000	ASSEMBLY, DISPLAY SHIELD	
3207367-312	SCREW, T10 TORX, 4-40 X .312	

### Guard & Feet Repair Kit (MIN 3305431-019)

Table 11.35—Guard & Feet Repair Kit Parts List

MIN	Description	Notes
3207247	FOOT-MOUNTING	
3206968	GUARD, CORNER LOWER LEFT	
3207307	GUARD, LOWER RIGHT	
3207361-375	SCREW, CAP SCH, TORX, 6-32 X .375L, SS	

### Handle Repair Kit (MIN 3305431-020)

Table 11.36—Handle Repair Kit Parts List

MIN	Description	Notes
3207706	HANDLE	
3207707	HANDLE COVER PLATE, LEFT	
3207746	HANDLE COVER PLATE, RIGHT	
201407-069	SCREW- 6-32 X .375	

### **NIBP Connector Repair Kit (MIN 3305431-022)**

**Table 11.37—NIBP Connector Repair Kit Parts List**

MIN	Description	Notes
3207033	PNEUMATIC COUPLER	
3207361-375	SCREW, CAP SCH, TORX, 6-32 X .375L, SS	
201407-069	SCREW- 6-32 X .375	
202253-763	SCREW-M PH, NYLOK 4-40 X .437	

### Front Case Repair Kit (MIN 3305431-023)

Table 11.38—Front Case Repair Kit Parts List

MIN	Description	Notes
3207725	ASSY - ENCLOSURE, FRONT	
3206724	LENS - DISPLAY	
3208003	LABEL - PHYSIO-CONTROL ICON	
804234	SEAL - PERIMETER, CASE	
202253-764	SCREW, MACHINE, PANHEAD, NYLOK, 4-40 X .500	
202253-761	SCREW-M, CS, Z, PH, NYLOCK, 4-40 X .312L	
3207361-375	SCREW, CAP SCH, TORX, 6-32 X .375L, SS	
201407-069	SCREW- 6-32 X .375	
202253-763	SCREW-M PH, NYLOK 4-40 X .437	
3207701	SEAL—THERAPY CONNECTOR	
3207367	SCREW—MACHINE, TRH, T10 TORX (R), 4-40, SS	



### Rear Case Repair Kit (MIN 3305431-024)

Table 11.39—Rear Case Repair Kit Parts List

MIN	Description	Notes
3207726	ASSY - ENCLOSURE, REAR	
3206960	FLEXIBLE GROUND PLANE - EMI SHIELD	
200060	AUX/SERIAL CONNECTOR O-RINGS	
802278	BANANA PINS	
200536	TIE WRAP, LG	
200536	CABLE TIES, SM	
202253-761	SCREW-M, CS, Z, PH, NYLOCK, 4-40 X .312L	
201407-069	SCREW- 6-32 X .375	
202253-763	SCREW-M PH, NYLOK 4-40 X .437	
3207361-375	SCREW, CAP SCH, TORX, 6-32 X .375L, SS	
3207337-312	SCREW-MACH, PNH, PHH, NYLOCK, 4-40, 0.312L, WSHR, CS, ZN	
3010805-000	SOCKET RETAINER CLIP - 10 PIN	

### MASIMO SpO2 Module Repair Kit (MIN 3305431-025)

Table 11.40—MASIMO SpO2 Module Parts List

MIN	Description	Notes
202253-760	SCREW-M, PH, NYLOK, CS, 4-40	
3207034	MODULE-OEM, PULSE OXIMETER, MX-1	
201407	SCREW—PANHEAD, PHILLIPS, STAINLESS STEEL, SELF-SEALING, SELF-LOCKING	
3207361	SCREW—CAP, SCH, REC T15 TORX 6-32, 0.375L, SS, NYLOK	
3010805	SOCKET—RETAINER CLIP	
3207337	SCREW—MACHINE, PNH, PHH, 4-40, NYLOK, CS, WITH WASHER	

### MASIMO SpO2 Panel Mount Cable Repair Kit (MIN 3305431-026)

Table 11.41—MASIMO SpO2 Panel Mount Cable Parts List

MIN	Description	Notes
3206995	CABLE ASSY - FLEX, SPO2, MASIMO	
3205311-001	SCREW, MACHINE, PAN, TORX, NYLOK, 4-40 X .687	
202253-763	SCREW, MACHINE, PANHEAD, NYLOK, 4-40 X .437	
201407	SCREW—PANHEAD, PHILLIPS, STAINLESS STEEL, SELF-SEALING, SELF-LOCKING	
3207361	SCREW—CAP, SCH, REC T15 TORX 6-32, 0.375L, SS, NYLOK	
3010805	SOCKET—RETAINER CLIP	
3207009	HOUSING—FERRITE, SPO2	
3207337	SCREW—MACHINE, PNH, PHH, 4-40, NYLOK, CS, WITH WASHER	

### Temperature Cable Repair Kit (MIN 3305431-027)

Table 11.42—Temperature Cable Repair Kit Parts List

MIN	Description	Notes
3207631-375	SCREW, CAP, SCH, REC T15 TORX 6-32, 0.375L, SS, NYLOK	
201407-069	SCREW, SELF-SEAL, SELF-LOCK, 6-32 X 0.375	
202253-763	SCREW, MACHINE, PANHEAD, NYLOK, 4-40 X .437	
3207337-312	SCREW, MACH, PNH, PHH, NYLOCK, 4-40, 0.312L, WSHR, CS, ZN	
3303936-001	CABLE ASSEMBLY - TEMPERATURE	
3007998-00	GASKET-CONNECTOR, INVASIVE PRESSURE	

### OEM PCBA Repair Kit, V2 (MIN 3305431-028)

Table 11.43—V2 OEM PCBA Repair Kit Parts List

MIN	Description	Notes
3207361-375	SCREW, CAP, SCH, REC T15 TORX 6-32, 0.375L, SS, NYLOK	
3207337-312	SCREW, MACH ,PNH, PHH, NYLOCK, 4-40, 0.312L, WSHR, CS, ZN	
3010805-000	SOCKET RETAINER CLIP—10 PIN	
202253-763	SCREW, MACH, PANHEAD, NYLOK, 4-40 X .437	
202253-761	SCREW-M, CS, Z, PH, NYLOCK, 4-40 X .312L	
201407-069	SCREW, SELF-SEAL, SELF-LOCK, 6-32 X 0.375	
3306308-000	PCB ASSY - OEM	

### Interface PCBA Repair Kit, V2 (MIN 3305431-029)

Table 11.44—V2 Interface PCBA Repair Kit Parts List

MIN	Description	Notes
3306367-000	PCB ASSY—INTERFACE, LP15 V2	
3207361-375	SCREW, CAP, SCH, REC T15 TORX 6-32, 0.375L, SS, NYLOK	
3206991-003	CABLE ASSY—FLEX, SYSTEM PCB/INTERFACE PCB	
202253-761	SCREW-M, CS, Z, PH, NYLOCK, 4-40 X .312L	
201407-069	SCREW, SELF-SEAL, SELF-LOCK, 6-32 X 0.375	

### Power PCBA Repair Kit, V2 (MIN 3305431-030)

Table 11.45—V2 Power PCBA Repair Kit Parts List

MIN	Description	Notes
3302519-002	PCB ASSY—POWER, LP15	
3207361-375	SCREW-CAP, SCH, REC T15 TORX 6-32, 0.375L, SS, NYLOK	
3207337-312	SCREW, MACH, PNH, PHH, NYLOCK, 4-40, 0.312L, WSHR, CS, ZN	
3010805-000	SOCKET RETAINER CLIP—10 PIN	
202253-763	SCREW, MACH, PANHEAD, NYLOK, 4-40 X .437	
202253-761	SCREW-M, CS, Z, PH, NYLOCK, 4-40 X .312L	
201407-069	SCREW, SELF-SEAL, SELF-LOCK, 6-32 X 0.375	

### System PCBA Repair Kit (MIN 3305431-031)

Table 11.46—System PCBA Repair Kit Parts List

MIN	Description	Notes
3009878	CONNECTOR—HDR, SQUARE PIN, DUAL ROW, 24 PIN	
3011630	SPACER—PCB, LP12	
202253	SCREW—MACHINE, PANHEAD, NYLOK	
3207337	SCREW—MACHINE, PNH, PHH, 4-40, NYLOCK, CS, WITH WASHER	
3010805	SOCKET—RETAINER CLIP	
3207361	SCREW—CAP, SCH, REC T15 TORX 6-32, 0.375L, SS, NYLOK	
201407	SCREW—PANHEAD, PHILLIPS, STAINLESS STEEL, SELF-SEALING, SELF-LOCKING	
3011629	INSERT—HEX, LP15	
3206834	PCB ASSY—SYSTEM, LP15	
3306020	INSULATOR—SYSTEM PCB, CENTER	
3306021	INSULATOR—SYSTEM PCB, RIGHT	
3306022	INSULATOR—SYSTEM PCB, LEFT	



Table 11.46—System PCBA Repair Kit Parts List (Continued)

MIN	Description	Notes
804447	SPACER—FOAM	
3011980	LABEL—SHOCK HAZARD	

## Defibrillator Part Number and Serial Number

### PN and SN Label

The LIFEPAK 15 monitor/defibrillator serial number (SN) and part number (PN) are noted on a label on the rear case assembly in Battery Well 1.

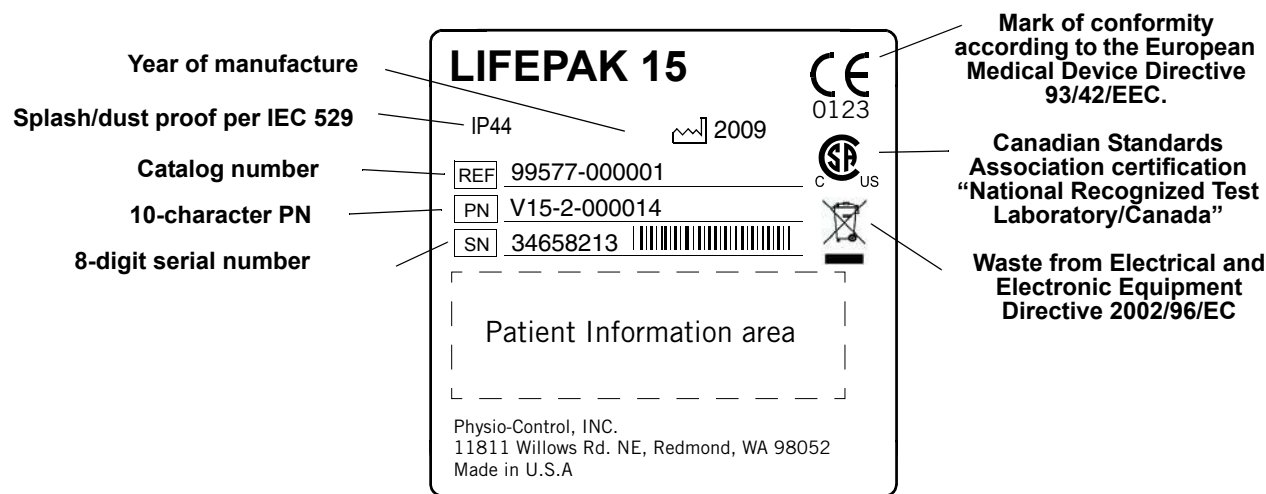

### Understanding the Part Number

The device part number, for example, V15-2-000014, reflects the device options, features, and language.

### Understanding the Serial Number

The serial number for the LIFEPAK 15 monitor/defibrillator is related to the sales order created during device manufacturing and appears on the serial number label in Battery Well 1. Use this number when calling to order parts.

## Ordering Parts

To order parts, contact your local Physio-Control representative. In the USA, call PARTSLINE™ at 1.800.442.1142. Provide the part number and serial number located on the device label in Battery Well 1. Specify all assembly numbers, MINs, reference designations, and descriptions. Parts may be substituted to reflect device modifications and improvements.

### Manufacturing Date

In some cases when ordering parts, you may also need the device manufacturing date. The date of manufacture is available by accessing the Service/Status/Device Data as described in [Device Data \(p. 230\)](#).

### Serial Number

The serial number of the device identifies the manufacturing conditions and elements used in producing your device. When ordering parts, use the serial number (SN) listed on the label in Battery Well 1.

# Index

## Numerics

12-lead button function [61](#)

12-lead ECG

accessories [66](#)

PIP tests [142](#)

3-lead ECG

PIP tests [147](#)

5-lead ECG

PIP tests [144](#)

## A

A01 system PCB, see system PCB (A10)

A03 power PCB, see power PCB (A03)

A04 therapy PCB, see therapy PCB (A04)

A05 interface PCB, see interface PCB (A05)

A06 OEM PCB, see OEM PCB (A06)

A07 contact PCB, see contact PCB (A07)

A08 backlight PCB, see backlight PCB (A08)

A09 printer control keypad, see printer control keypad (A09)

A10 main keypad, see main keypad (A10)

A11 LCD assembly, see LCD assembly (A11)

A12 Printer

PIP tests [133](#)

A12 printer assembly, see printer assembly (A12)

A13 transfer relay assembly, see transfer relay assembly (A)

A14 inductive resistor, see inductive resistor (A14)

A15 energy storage capacitor, see energy storage capacitor (A15)

A16 SpO2 module, see SpO2 module (A16)

A17 interconnect bracket, see interconnect bracket (A17)

A21 NIBP module, see NIBP module (A21)

A22 biphasic module, see biphasic module (A22)

A23 CO2 module, see CO2 module (A23)

acronyms [25](#)

Adobe Reader [13](#)

AED mode

definition [50](#)

setup [91](#)

ALARMS button function [57](#)

ANALYZE button function [57](#)

archive mode [97](#)

auxiliary connector cable (W09)

replacing [451](#)

## B

backlight PCB (A08)

description [84](#)

diagram [569](#)

replacing [315](#)

backlight PCB/interface PCB cable (W06)

diagram [587](#)

replacing [333](#)

batteries

charger accessories [67](#)

charging [284](#)

coin [288](#)

description [279](#)

discarding/recycling [285](#)

fuel gauge [281](#)

maintenance [278](#)

new [287](#)

performance characteristics [283](#)

status indicators [280](#)

storing [286](#)

battery compartments description [63](#)

battery pins

replacing [484](#)

battery pins/power PCB cable (W10)

diagram [591](#)

replacing [454](#)

biphasic cable (W20)

replacing [460](#)

Biphasic defibrillator output waveform test [203](#)

biphasic module (A13)

description [86](#)

biphasic module (A22)

diagram [580](#)

replacing [418](#)

biphasic to therapy PCB flex cable (W20)

diagram [601](#)

Bluetooth, PIP test [216](#)

## C

cable

backlight PCB/interface PCB cable (W06)

diagram [587](#)

battery pins/power PCB (W10) [591](#)

biphasic to therapy PCB flex cable (W20) [601](#)

CO2 inlet connector (W28) [606](#)

- CO2 module adapter (W29) [607](#)
  - ECG connector cable (W07) diagram [588](#)
  - LCD assembly/interface PCB (W18) [599](#)
  - main keypad/interface PCB cable (W13) [594](#)
  - OEM PCB/NIBP module (W27) [605](#)
  - OEM PCB/SpO2 module (W21) [602](#)
  - power PCB/contact PCB (W05) diagram [586](#)
  - power PCB/system PCB (W01) diagram [582](#)
  - power PCB/therapy PCB (W02) diagram [583](#)
  - printer assembly/chasis ground (W19) [600](#)
  - printer assembly/interface PCB (W16) [597](#)
  - printer control keypad/interface PCB (W12) [593](#)
  - SpO2 connector (W22) [603](#)
  - system connector (W08) [589, 590](#)
  - system PCB/interface PCB (W04) [585](#)
  - therapy connector (W11) [592](#)
  - Calibration
    - CO2 [207](#)
    - defibrillator [200](#)
    - instrument [188](#)
    - menu access [194](#)
    - pacemaker [213](#)
    - printer [211, 212](#)
  - Canadian Standards Association [39](#)
  - capacitor discharge tool [297](#)
  - device tracking [18](#)
  - CHARGE button function [58](#)
  - cleaning
    - exterior [274](#)
    - tools and materials [273](#)
  - clearing data management memory [238](#)
  - CO2
    - calibration [207](#)
    - diagram [533](#)
    - parts list [535](#)
    - PIP tests [124](#)
  - CO2 connector cable (W28)
    - description [88](#)
    - diagram [606](#)
    - replacing [470](#)
  - CO2 module
    - replacing (A23) [407](#)
  - CO2 module (A23)
    - description [86](#)
    - diagram [581](#)
    - exhaust port [63](#)
    - repair kit [614](#)
  - CO2 module adapter cable (W29)
    - diagram [607](#)
  - coin battery
    - description [288](#)
    - replacing [482](#)
  - Computer communication setup [216](#)
  - configuration options [22](#)
  - contact PCB (A07)
    - description [84](#)
    - diagram [568](#)
    - replacing [479](#)
  - contacting Physio-Control [16](#)
  - corrective action codes [260](#)
  - Counters [141](#)
  - counters [236](#)
  - CPR button function [57](#)
  - CURRENT button function [58](#)
- D**
- data management memory, clearing [238](#)
  - data management options [68](#)
  - Defibrillator calibration [200](#)
  - Defibrillator isolation test [206](#)
  - Delivered energy test [201](#)
  - demo mode [96](#)
  - device log [228](#)
  - device self tests [266](#)
  - device user test [267](#)
  - diagram
    - assembly configurator [488](#)
    - backlight PCB (A08) [569](#)
    - backlight PCB/interface PCB cable (W06) [587](#)
    - battery pins/power PCB cable (W10) [591](#)
    - biphasic module (A22) [580](#)
    - biphasic to therapy PCB flex cable (W20) [601](#)
    - CO2 [533](#)
    - CO2 inlet connector cable (W28) [606](#)
    - CO2 module (A23) [581](#)
    - CO2 module adapter cable (W29) [607](#)
    - contact PCB (A07) [568](#)
    - ECG connector cable (W07) [588](#)
    - energy storage capacitor (A15) [576](#)
    - external front connections [71](#)
    - external parts [492](#)
    - front [497](#)
    - front panel features [55](#)
    - inductive resistor (A14) [575](#)
    - inside front case [309](#)
    - inside rear case [348](#)
    - interconnect [488](#)

interconnect bracket (A17) [578](#)  
 interface PCB (A05) [566](#)  
 invasive pressure connection [72](#)  
 invasive pressure connector assembly (W33)  
     [608, 609](#)  
 LCD assembly [572](#)  
 LCD assembly/interface PCB cable (W18) [599](#)  
 main keypad (A10) [571](#)  
 main keypad/interface PCB cable (W13) [594](#)  
 NIPB [533](#)  
 NIPB module (A21) [579](#)  
 OEM PCB (A06) [567](#)  
 OEM PCB/NIBP module cable (W27) [605](#)  
 OEM PCB/SpO2 module cable (W21) [602](#)  
 parameter bezel [512](#)  
 power PCB (A03) [564](#)  
 power PCB/contact PCB cable (W05) [586](#)  
 power PCB/system PCB cable (W01) [582](#)  
 power PCB/therapy PCB cable (W02) [583](#)  
 printer assembly [573](#)  
 printer assembly/chasis ground cable (W19)  
     [600](#)  
 printer assembly/interface PCB cable (W16)  
     [597](#)  
 printer control keypad (09) [570](#)  
 printer control keypad/interface PCB cable  
     (W12) [593](#)  
 rear [519](#)  
 rear panel features [62](#)  
 speaker assembly (W17) [598](#)  
 speed dial assembly (W15) [595, 596](#)  
 SpO2 [533](#)  
 SpO2 connector cable (W22) [603](#)

SpO2 module (A16) [577](#)  
 system block [76](#)  
 system PCB (A01) [563](#)  
 system PCB/interface PCB cable (W04) [585](#)  
 system PCB/therapy PCB connector (W03) [584](#)  
 system/therapy assembly [507](#)  
 therapy connector cable (W11) [592](#)  
 therapy PCB (A01) [565](#)  
 discharging the energy storage capacitor [298](#)  
 discharging the pacing capacitor [299](#)  
 DISPLAY MODE button function [59](#)  
 document CD  
     Adobe Reader [13](#)  
     navigation instructions [14](#)  
**E**  
 ECG  
     connection port [61](#)  
 ECG connector cable (W07)  
     description [86](#)  
     diagram [588](#)  
     replacing [448](#)  
 electrode options [67](#)  
 EMI shield  
     replacing [425](#)  
 ENERGY SELECT button function [58](#)  
 energy storage capacitor (A15)  
     diagram [576](#)  
     replacing [391](#)  
 energy storage capacitor, discharging [298](#)  
 energy transfer detail [351](#)  
 energy transfer detail diagram  
     diagram [351](#)

error codes  
     categories [239](#)  
     processing [235](#)  
 EVENT button function [58](#)  
 Event marker [41](#)  
 external parts  
     diagram [492](#)  
     parts list [494](#)  
**F**  
 front  
     diagrams [497](#)  
     parts list [501](#)  
 front case  
     inside diagram [309](#)  
     replacing [328](#)  
 front panel features [55](#)  
**G**  
 glossary [23](#)  
**H**  
 Heart rate/pulse rate indicator [37](#)  
 HOME SCREEN button function [58](#)  
**I**  
 inductive resistor (A14)  
     description [85](#)  
     diagram [575](#)  
     replacing [418](#)  
 inside front case diagram [309](#)  
 Instrument calibration [188](#)  
 interconnect bracket (A17)

- diagram [578](#)
- replacing [404](#)
- interconnect diagram [488](#)
- interface PCB (A05)
  - description [82](#)
  - diagram [566](#)
  - replacing [310](#)
- Invasive pressure
  - PIP test [138](#)
- invasive pressure
  - connection ports [61](#)
  - repair kit [613](#)
- invasive pressure connector assembly (W33)
  - description [88](#)
  - diagram [608](#), [609](#)
  - replacing [475](#)

## L

- labels
  - SN/PN [638](#)
- LCD assembly (A11)
  - description [84](#)
  - diagram [572](#)
  - replacing [324](#)
- LCD assembly/interface PCB cable (W18)
  - diagram [599](#)
  - replacing [346](#)
- LEAD button function [57](#)
- LIFENET Device Communications [216](#)
- LIFEPAK 12
  - reassembling the case [304](#)
  - software and device upgrades [485](#)
- LIFEPAK 15

- assemblies [52](#)
- basic components [64](#)
- carrying bags [68](#)
- cleaning [273](#)
- configuration options [22](#)
- description [48](#)
- device tracking [18](#)
- energy delivery definition [49](#)
- environmental conditions [275](#)
- external front connections [71](#)
- front panel features [55](#)
- functional descriptions [74](#)
- invasive pressure connection [72](#)
- maintenance [265](#)
- manufacturing date [639](#)
- optional features [65](#)
- options, supplies, and accessories [65](#)
- pacing waveform definition [50](#)
- part number [638](#)
- primary functions [50](#)
- rear panel features [62](#)
- serial number [638](#)
- service technician qualifications [15](#)
- support policy [272](#)
- TCP setup [193](#)
- useful life [271](#)
- user test [268](#)
- waveform technology [49](#)

List [527](#)

## M

- main keypad (A10)
  - description [84](#)

- diagram [571](#)
- replacing [320](#)
- main keypad/interface PCB cable (W13)
  - diagram [594](#)
  - replacing [337](#)
- MAINTENANCE DUE message [270](#)
- Maintenance prompt
  - disabling [187](#)
  - setting interval [187](#)
- maintenance prompt interval setup [270](#)
- manual mode
  - accessing [90](#)
  - definition [50](#)
- Manual mode access [106](#)
- manufacturing date [639](#)
- modes of operation [89](#)

## N

- navigation
  - using Adobe Reader [13](#)
  - using hyperlinks [14](#)
- NIBP
  - calibration [129](#)
  - connector function [61](#)
  - connector replacement [426](#)
  - diagram [533](#)
  - parts list [534](#)
- NIBP module (A21)
  - description [86](#)
  - diagram [579](#)
  - repair kit [612](#)
  - replacing [407](#)

## O

- OEM PCB (A06)
  - description [83](#)
  - diagram [567](#)
  - replacing [381](#)
- OEM PCB/CO2 module cable (W26)
  - replacing [466](#)
- OEM PCB/NIBP module cable (W27)
  - diagram [605](#)
  - replacing [468](#)
- OEM PCB/SpO2 module cable (W21)
  - diagram [602](#)
  - replacing [462](#)
- optional features [65](#)
- OPTIONS button function [58](#)
- ordering parts [639](#)
  - manufacturing date [639](#)

## P

- Pace arrow
  - Internal pacing [41](#)
  - Noninvasive pacing [41](#)
- Pacer
  - PIP tests [168](#)
  - self-calibration [213](#)
  - verification test [214](#)
- PACER button function [58](#)
- pacing capacitor, discharging [299](#)
- paddles
  - storage [63](#)
- parameter bezel
  - diagrams [512](#)

- parts list [516](#)
- replacing [429](#)
- parts
  - ordering [639](#)
- parts list
  - CO2 [535](#)
  - external parts [494](#)
  - front [501](#)
  - NIBP [534](#)
  - parameter bezel [516](#)
  - printer control keyboard language [538](#)
  - product ID label language [544, 551](#)
  - rear [527](#)
  - SpO2 [534](#)
  - system/therapy assembly
    - [509](#)
- Patient Impedance, PIP test [171](#)
- PAUSE button function [59](#)
- Performance inspection procedures (see also *PIP*)
  - [98](#)
- PIP
  - 12-lead ECG tests [142](#)
  - 3-lead ECG tests [147](#)
  - 5-lead ECG tests [144](#)
  - Bluetooth test [216](#)
  - CO2 calibration [125](#)
  - CO2 leakage test [124](#)
  - date/time verification [118](#)
  - device preparation [110](#)
  - ECG analog output test [150](#)
  - instructions [110](#)
  - invasive pressure test [138](#)
  - leakage tests [177](#)

- Manual mode access [106](#)
- NIBP tests [129](#)
- pacer tests [168](#)
- patient impedance test [171](#)
- power on/self-test [114](#)
- power source management test [117](#)
- recording operating data [141](#)
- resetting maintenance prompt [187](#)
- resource requirements [101](#)
- test equipment requirements [102](#)
- user test [118](#)
- power options [67](#)
- power PCB (A03)
  - description [79](#)
  - diagram [564](#)
  - replacing [373](#)
- power PCB/contact PCB cable (W05)
  - diagram [586](#)
  - replacing [446](#)
- power PCB/system PCB cable (W01)
  - diagram [582](#)
  - replacing [443](#)
- power PCB/therapy PCB cable (W02)
  - diagram [583](#)
  - replacing [444](#)
- preventive maintenance [265](#)
  - testing schedule [268](#)
- Printer (see also *A12 Printer*)
  - calibration [211, 212](#)
- printer assembly (A12)
  - description [84](#)
  - diagram [573](#)
  - maintenance [276](#)



- printer paper [69](#)
- replacing [480](#)
- printer assembly/chassis ground cable (W19)
  - diagram [600](#)
  - replacing [347](#)
- printer assembly/interface PCB cable (W16)
  - diagram [597](#)
  - replacing [341](#)
- printer control keypad (A09)
  - diagram [570](#)
  - language parts list [538](#)
  - replacing [318](#)
- printer control keypad/interface PCB cable (W12)
  - diagram [593](#)
  - replacing [336](#)
- printer paper [69](#)

## R

- RATE button function [58](#)
- rear
  - diagrams [519](#)
  - parts list [527](#)
- rear case
  - diagrams [348](#)
  - replacing [435](#)
- rear panel features [62](#)
- Recording operating data [141](#)
- recycling
  - batteries [285](#)
  - general information [20](#)
- repair kit
  - CO2 module [614](#)
  - invasive pressure connector [613](#)

- list of all kits [610](#)
- NIBP module (A21) [612](#)
- replacement procedures [289](#)
  - tools needed [296](#)
  - warnings and cautions [293](#)
- replacing [477](#)
- responsibility for information [17](#)
- R-wave sense marker [41](#)

## S

- safety
  - introduction [29](#)
- scheduled replacement items [269](#)
- service information [19](#)
- service LED [263](#)
- service LED function [57](#)
- service log [233](#)
- Service mode [93](#)
- setup configuration
  - saving and restoring [300](#)
- Setup mode [92](#)
- SHOCK button function [58](#)
- SIZE button function [57](#)
- speaker assembly (W17)
  - description [87](#)
  - diagram [598](#)
  - replacing [343](#)
- speed dial assembly (W15)
  - description [87](#)
  - diagram [595, 596](#)
  - replacing [338](#)
- SPEED DIAL function [59](#)
- SpO2
  - diagram [533](#)
  - parts list [534](#)
- SpO2 connector cable (W22)
  - description [87](#)
  - diagram [603](#)
  - replacing [464](#)
- SpO2 module (A16)
  - description [85](#)
  - diagram [577](#)
  - replacing [394](#)
- status menu [226](#)
- symbols [36](#)
- SYNC button function [57](#)
- system block diagram [76](#)
- system connector cable
  - description [86](#)
- system connector cable (W08) [589, 590](#)
  - diagram [589, 590](#)
  - replacing [451](#)
- system connector definition [63](#)
- system PCB (A01)
  - description [77](#)
  - diagram [563](#)
- system PCB/interface PCB cable (W04)
  - diagram [585](#)
  - replacing [332](#)
- system PCB/therapy PCB connector (W03)
  - diagram [584](#)
- system/therapy assembly
  - diagrams [507](#)
  - parts list [509](#)
- system/therapy PCBs
  - replacing [352](#)

**T**

## TCP

- resource requirements [190](#)
- scope and applicability [189](#)
- setup [193](#)

- test equipment requirements [191](#)

Temperature Cable Assembly (W34) [477](#)terms [30](#)Test and calibration procedures (see also *TCP*) [188](#)therapy cable receptacle function [61](#)

## therapy connector cable (W11)

- description [87](#)
- diagram [592](#)
- replacing [334](#)

therapy delivery options [66](#)

## therapy PCB (A04)

- description [80](#)
- diagram [565](#)

trademarks [12](#)training/testing tools [68](#)transfer relay assembly (A13) [574](#)

- description [85](#)
- diagram [574](#)
- replacing [388](#)

## troubleshooting

- clearing memory [238](#)
- corrective actions [219](#)
- corrective action codes [260](#)
- counters [236](#)
- device log [228](#)
- error code categories [239](#)
- introduction [218](#)

pixels test [264](#)processing error codes [235](#)service LED [263](#)service log [233](#)user test [268](#)**W**

## W07, see ECG connector cable (W07)

## W08, see system connector cable (W08)

## W11, see therapy connector cable (W11)

## W15, see speed dial assembly (W15)

## W17, see speaker assembly (W17)

## W22, see SpO2 connector cable (W22)

## W28, see CO2 inlet connector cable (W28)

## W33, see IP connector cable (W33)

## warnings and cautions

- replacement procedures [293](#)

safety [31](#)warranty [21](#)

## Performance Inspection Procedure Checklist

Model # \_\_\_\_\_ Department/Location \_\_\_\_\_  
 Serial # \_\_\_\_\_ Performed By \_\_\_\_\_  
 Type of PIP: Post-Repair  Annual  Date \_\_\_\_\_

Manual Mode Access		Pass	Fail	NA	Comments
<b>1</b>	<b>Manual Mode Access</b> Customer-selected MANUAL ACCESS configuration				
Device Preparation		Pass	Fail	NA	Comments
<b>2</b>	<b>Exterior Physical Inspection</b>				
	Device exterior damage (general)	<input type="checkbox"/>	<input type="checkbox"/>	<input type="checkbox"/>	
	Check device for loose/rattling hardware	<input type="checkbox"/>	<input type="checkbox"/>	<input type="checkbox"/>	
	Check for damaged or missing rubber feet	<input type="checkbox"/>	<input type="checkbox"/>	<input type="checkbox"/>	
	Inspect battery connector pins	<input type="checkbox"/>	<input type="checkbox"/>	<input type="checkbox"/>	
	Inspect therapy cable pins and connector	<input type="checkbox"/>	<input type="checkbox"/>	<input type="checkbox"/>	
	Confirm spring button on therapy connector is functional	<input type="checkbox"/>	<input type="checkbox"/>	<input type="checkbox"/>	
	Inspect device cables for damage	<input type="checkbox"/>	<input type="checkbox"/>	<input type="checkbox"/>	
	Inspect keypads and overlays for damage	<input type="checkbox"/>	<input type="checkbox"/>	<input type="checkbox"/>	
	Check device accessories for condition and expiration dates	<input type="checkbox"/>	<input type="checkbox"/>	<input type="checkbox"/>	
	Inspect carrying case and carrying strap for condition	<input type="checkbox"/>	<input type="checkbox"/>	<input type="checkbox"/>	
<b>3</b>	<b>Device Setup</b>				
	<ul style="list-style-type: none"> <li>Engage two fully charged Li-ion batteries into the device</li> <li>Install a roll of 100-mm printer paper</li> <li>Connect therapy cable to the device</li> </ul>				<input type="checkbox"/> Complete
Power Management		Pass	Fail	N/A	Comments
<b>4</b>	<b>Power On/Self Test</b>				
	<ul style="list-style-type: none"> <li>All items are conforming</li> </ul>	<input type="checkbox"/>	<input type="checkbox"/>	<input type="checkbox"/>	
<b>5</b>	<b>Auxiliary Power Switching</b> (if Auxiliary power connector is installed)				
	<ul style="list-style-type: none"> <li>Auxiliary status indicators switch</li> </ul>	<input type="checkbox"/>	<input type="checkbox"/>	<input type="checkbox"/>	
<b>6</b>	<b>Power Source Management</b>				
	<ul style="list-style-type: none"> <li>Confirm battery status indicator switching</li> </ul>	<input type="checkbox"/>	<input type="checkbox"/>	<input type="checkbox"/>	
User Test and Date/Time Verification		Pass	Fail	N/A	Comments
<b>7</b>	<b>User Test and Date/Time Verification</b>				
	<ul style="list-style-type: none"> <li>Confirm device passes User Test</li> <li>Confirm Time and Date are correct</li> </ul>	<input type="checkbox"/>	<input type="checkbox"/>	<input type="checkbox"/>	
		<input type="checkbox"/>	<input type="checkbox"/>	<input type="checkbox"/>	
Miscellaneous Functions		Pass	Fail	N/A	Comments
<b>8</b>	<b>Temperature Calibration Check Test</b> (if Temp option is installed)				
	<ul style="list-style-type: none"> <li>Confirm Temperature Cal Check complete</li> </ul>	<input type="checkbox"/>	<input type="checkbox"/>	<input type="checkbox"/>	
<b>9</b>	<b>CO2 Tests</b> (if CO2 option is installed)				
	<ul style="list-style-type: none"> <li>Confirm change in vacuum reading is less than 15 mmHg</li> <li>Confirm CO2 concentration reading is 5.0% ±0.5%</li> </ul>	<input type="checkbox"/>	<input type="checkbox"/>	<input type="checkbox"/>	
		<input type="checkbox"/>	<input type="checkbox"/>	<input type="checkbox"/>	
<b>10</b>	<b>NIBP Tests</b> (if NIBP option is installed)				
	<ul style="list-style-type: none"> <li>Confirm LEAKAGE TEST OK message</li> <li>Confirm 50 mmHg and 150 mmHg, readings agree within ±2 mmHg</li> <li>Confirm the overpressure switch activates at 285 mmHg ±8 mmHg</li> </ul>	<input type="checkbox"/>	<input type="checkbox"/>	<input type="checkbox"/>	
		<input type="checkbox"/>	<input type="checkbox"/>	<input type="checkbox"/>	
		<input type="checkbox"/>	<input type="checkbox"/>	<input type="checkbox"/>	

# LIFEPAK 15 Monitor/Defibrillator

Miscellaneous Functions (continued)		Pass	Fail	N/A	Comments
<b>11</b>	<b>25 mm/s Speed Printer Test</b> Confirm printer test strip and CHECK PRINTER message	<input type="checkbox"/>	<input type="checkbox"/>	<input type="checkbox"/>	
<b>12</b>	<b>12.5 mm/s Speed Printer Test</b> Confirm printer 12.5 mm/s test strip	<input type="checkbox"/>	<input type="checkbox"/>	<input type="checkbox"/>	
<b>13</b>	<b>Keypad Test</b> Confirm all control text boxes are highlighted and TEST COMPLETE message appears	<input type="checkbox"/>	<input type="checkbox"/>	<input type="checkbox"/>	
<b>14</b>	<b>Audio Test</b> Confirm voice messages and tones are clear and not distorted	<input type="checkbox"/>	<input type="checkbox"/>	<input type="checkbox"/>	
<b>15</b>	<b>Invasive Blood Pressure Verification</b> (if IP option is installed) a. Confirm P1 pressure channel zero b. Confirm 250 ±8 mmHg, 100 ±5 mmHg, 40 ±4 mmHg, and 20 ±3 mmHg c. Confirm -20 ±3 mmHg d. Confirm P2 pressure channel zero e. Confirm 250 ±8 mmHg, 100 ±5 mmHg, 40 ±4 mmHg, and 20 ±3 mmHg f. Confirm -20 ±3 mmHg	<input type="checkbox"/> <input type="checkbox"/> <input type="checkbox"/> <input type="checkbox"/> <input type="checkbox"/> <input type="checkbox"/>	<input type="checkbox"/> <input type="checkbox"/> <input type="checkbox"/> <input type="checkbox"/> <input type="checkbox"/> <input type="checkbox"/>	<input type="checkbox"/> <input type="checkbox"/> <input type="checkbox"/> <input type="checkbox"/> <input type="checkbox"/> <input type="checkbox"/>	
<b>16</b>	<b>SpO2/SpCO/SpMet Tests</b> a. Confirm SpO2 reading is between 50% and 100% (if SpO2 is installed) b. Confirm SpCO reading is between 0% and 40% (if SpCO is installed) c. Confirm SpMet reading is between 0% and 15% (if SpMet is installed)	<input type="checkbox"/> <input type="checkbox"/> <input type="checkbox"/>	<input type="checkbox"/> <input type="checkbox"/> <input type="checkbox"/>	<input type="checkbox"/> <input type="checkbox"/> <input type="checkbox"/>	
<b>17</b>	<b>Record Operating Data</b>  Total Shocks _____  360J Shocks <input type="text"/> _____  225-325J Shocks <input type="text"/> _____  0-200J Shocks <input type="text"/> _____				Fault Messages _____ Power Cycle Count _____ Pacing Count _____ Shock Count _____ Power On Time _____ Printer On Time _____ SpO2 Operating Time (if installed) _____ CO2 Operating Time (if installed) _____ NIBP Inflation Cycles (if installed) _____
ECG Performance Testing		Pass	Fail	N/A	Comments
<b>18</b>	<b>12-Lead ECG Tests</b> (Alternative: 3-lead or 5-wire ECG tests) a. Confirm LEADS-OFF screen messages b. Confirm Lead I gain (tolerance 25 to 31 mm) c. Confirm Lead II & all V leads gain (tolerance 36 to 44 mm)	<input type="checkbox"/> <input type="checkbox"/> <input type="checkbox"/>	<input type="checkbox"/> <input type="checkbox"/> <input type="checkbox"/>	<input type="checkbox"/> <input type="checkbox"/> <input type="checkbox"/>	
<b>19</b>	<b>5-Wire ECG Tests</b> (Alternative: 12-lead or 3-lead ECG tests) a. Confirm LEADS-OFF screen messages b. Confirm Lead I gain (tolerance 25 to 31 mm) c. Confirm Leads II & V1/C gain (tolerance 36 to 44 mm)	<input type="checkbox"/> <input type="checkbox"/> <input type="checkbox"/>	<input type="checkbox"/> <input type="checkbox"/> <input type="checkbox"/>	<input type="checkbox"/> <input type="checkbox"/> <input type="checkbox"/>	
<b>20</b>	<b>3-Lead ECG Tests</b> (Alternative: 12-lead or 5-wire ECG tests) a. Confirm LEADS-OFF screen messages b. Confirm Lead I gain (tolerance 25 to 31 mm) c. Confirm Lead II gain (tolerance 36 to 44 mm)	<input type="checkbox"/> <input type="checkbox"/> <input type="checkbox"/>	<input type="checkbox"/> <input type="checkbox"/> <input type="checkbox"/>	<input type="checkbox"/> <input type="checkbox"/> <input type="checkbox"/>	
<b>21</b>	<b>ECG Analog Output</b> (optional, perform as required) Record signal amplitude (tolerance 0.90 to 1.10 Vp-p)				Amplitude: _____ Vp-pr

# LIFEPAK 15 Monitor/Defibrillator

Defibrillator / Pacing Testing		Pass	Fail	N/A	Comments
<b>22</b>	<b>Delivered Energy Test</b> 10 J – Record delivered energy (tolerance 9.1 to 10.9 J) 200 J – Record delivered energy (tolerance 186.0 to 214.0 J) 360 J – Record delivered energy (tolerance 334.9 to 384.9 J)				Energy Level: _____ J Energy Level: _____ J Energy Level: _____ J
<b>23</b>	<b>Charge Time to 360J Test</b> Confirm device charges to 360 J in less than 10 seconds	<input type="checkbox"/>	<input type="checkbox"/>	<input type="checkbox"/>	
<b>24</b>	<b>Synchronous Cardioversion Test</b> d. Record Sync delay (maximum 60 ms)				Sync: _____ ms
<b>25</b>	<b>Therapy ECG Characteristics</b> a. Record ECG paddle lead gain (tolerance 1mV = 36 to 44 mm) b. Fast-Restore baseline in 0.5 seconds c. Fast-Restore amplitude restored is >50% within 3 seconds d. Positive R-wave test				Amplitude: _____ mm <input type="checkbox"/> <input type="checkbox"/> <input type="checkbox"/> <input type="checkbox"/> <input type="checkbox"/> <input type="checkbox"/> <input type="checkbox"/> <input type="checkbox"/> <input type="checkbox"/>
<b>26</b>	<b>Hard Paddles User Test</b> (N/A for QUIK-COMBO-only device) Confirm device passes test	<input type="checkbox"/>	<input type="checkbox"/>	<input type="checkbox"/>	
<b>27</b>	<b>Pacer Option Characteristics</b> a. Confirm leads-off detection b. 10 mA – Record current (tolerance 5.2 to 14.8 mA) 100 mA – Record current (tolerance 95.2 to 104.8 mA) 200 mA – Record current (tolerance 190.2 to 209.8 mA) c. Record pulse width (tolerance 19.2 to 20.8 ms)				<input type="checkbox"/> <input type="checkbox"/> <input type="checkbox"/> Current Level: _____ mA Current Level: _____ mA Current Level: _____ mA Pulse Width: _____ ms
<b>28</b>	<b>Patient Impedance Test</b> a. Verify the PADDLES LEADS OFF message is not visible (50 ohms) b. Verify the device displays PADDLES LEADS OFF message (370 ohms) c. Verify the PADDLES LEADS OFF message is not visible (238 ohms)	<input type="checkbox"/>	<input type="checkbox"/>	<input type="checkbox"/>	<input type="checkbox"/> <input type="checkbox"/> <input type="checkbox"/> <input type="checkbox"/> <input type="checkbox"/> <input type="checkbox"/> <input type="checkbox"/> <input type="checkbox"/> <input type="checkbox"/>
Data Management		Pass	Fail	N/A	Comments
<b>29</b>	<b>Bluetooth Wireless Technology</b> (if Bluetooth option is installed) Verify Bluetooth Pairing Successful	<input type="checkbox"/>	<input type="checkbox"/>	<input type="checkbox"/>	
Leakage Current Tests		Pass	Fail	N/A	Comments
<b>30</b>	<b>Leakage Test Battery Powered for 120VAC</b> a. ECG Direct Applied Part at 120VAC Polarity <b>NC/RM</b> , Condition <b>Normal</b> , (5 µA - 45 µA) b. Therapy Direct Applied Part at 120VAC Polarity <b>NC/RM</b> , Condition <b>Normal</b> , (5 µA - 2625 µA) c. SpO2 Direct Applied Part at 120VAC Polarity <b>NC/RM</b> , Condition <b>Normal</b> , (5 µA - 2625 µA)				Current Level: _____ µA Current Level: _____ µA Current Level: _____ µA
<b>31</b>	<b>Leakage Test Battery Powered for 240VAC</b> a. ECG Direct Applied Part at 240VAC Polarity <b>NC/RM</b> , Condition <b>Normal</b> , (5 µA - 45 µA) b. Therapy Direct Applied Part at 240VAC Polarity <b>NC/RM</b> , Condition <b>Normal</b> , (5 µA - 2625 µA) c. SpO2 Direct Applied Part at 240VAC Polarity <b>NC/RM</b> , Condition <b>Normal</b> , (5 µA - 2625 µA)				Current Level: _____ µA Current Level: _____ µA Current Level: _____ µA
<b>32</b>	<b>Leakage Test AC Powered Device at 120VAC</b> (If Aux power is installed) a. Direct Equipment Leakage at 120 VAC Polarity <b>NC/RM</b> , Condition <b>Open Earth</b> , (15 µA - 270 µA) b. ECG Direct Applied Part at 120VAC Polarity <b>NC/RM</b> , Condition <b>Normal</b> , (5 µA - 45 µA) c. Therapy Direct Applied Part at 120VAC Polarity <b>NC/RM</b> , Condition <b>Normal</b> , (5 µA - 2625 µA)				Current Level: _____ µA Current Level: _____ µA Current Level: _____ µA

# LIFEPAK 15 Monitor/Defibrillator

Leakage Current Tests (continued)		Pass	Fail	N/A	Comments
d.	SpO2 Direct Applied Part at 120VAC Polarity <b>NC/RM</b> , Condition <b>Normal</b> , (5 $\mu$ A - 2625 $\mu$ A) Current Level: _____ $\mu$ A				
<b>33</b>	<b>Leakage Test AC Powered Device at 240VAC</b> (if Aux power is installed)				
a.	Direct Equipment Leakage at 240 VAC Polarity <b>NC/RM</b> , Condition <b>Open Earth</b> , (15 $\mu$ A - 450 $\mu$ A) Current Level: _____ $\mu$ A				
b.	ECG Direct Applied Part at 240VAC Polarity <b>NC/RM</b> , Condition <b>Normal</b> , (5 $\mu$ A - 45 $\mu$ A) Current Level: _____ $\mu$ A				
c.	Therapy Direct Applied Part at 240VAC Polarity <b>NC/RM</b> , Condition <b>Normal</b> , (5 $\mu$ A - 2625 $\mu$ A) Current Level: _____ $\mu$ A				
d.	SpO2 Direct Applied Part at 240VAC Polarity <b>NC/RM</b> , Condition <b>Normal</b> , (5 $\mu$ A - 2625 $\mu$ A) Current Level: _____ $\mu$ A				
<b>34</b>	<b>LIFEPAK 15 Maintenance Instruction</b>				
	Maintenance prompt disabled or reset	<input type="checkbox"/>	<input type="checkbox"/>	<input type="checkbox"/>	

# LIFEPAK® 15 MONITOR/DEFIBRILLATOR

---

## SERVICE MANUAL

For further information, please call Physio-Control at 1.800.442.1142 or visit [www.physio-control.com](http://www.physio-control.com)



Physio-Control, Inc.  
11811 Willows Road NE  
P.O. Box 97006  
Redmond, WA 98073-9708 USA  
Telephone: 425.867.4000  
Fax: 425.867.4861  
[www.physio-control.com](http://www.physio-control.com)



Medtronic B.V.  
Earl Bakkenstraat 10  
6422 PJ Heerlen  
The Netherlands

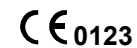

---

©2011 Physio-Control, Inc. All rights reserved. Specifications are subject to change without notice.

Publication Date: June, 2011

 3309059-000